

# HAHNREITER

GEWINDETECHNIK



**Gewindeschneiden & Lehren**  
**Thread Cutting & Gauges**



## Schleiftechnik

### • Gewindeschleifen

Schleiflänge max. 500 mm, Schleif-Ø max. 300 mm.  
Wir schleifen für Sie Gewindeprofile aller Art mit beliebigen Steigungen, ein- oder mehrgängig, z. B. Bohrspindeln, Schneckenwellen, Gewindekerne für Kunststoffspritzgussformen, Erodiererelektroden usw.

### • Aussen-Rundschleifen zwischen den Spitzen

Max. Einspannlänge 1.000 mm, max. Schleif-Ø 370 mm.

### • Spitzenlos-Rundschleifen (Einstechschleifen)

### • Innen-Rundschleifen

### • Flachsleifen

### • Zentrierbohrung-Schleifen

Bitte fordern Sie unseren Prospekt an.  
Wir freuen uns auf Ihre detaillierte Anfrage!

## Grinding Services

### • Thread grinding

### • Cylindrical grinding, external

### • Centerless grinding

### • Cylindrical grinding, internal

### • Surface grinding

*Please give us your detailed enquiry*



## Schweißtechnik

Wir sind spezialisiert auf Schweißarbeiten in den Bereichen

### • Abbrennstumpfschweißen

### • Reibschweißen

mit anschließender Wärmebehandlung.

Bearbeitungsmöglichkeiten:

- zylindrische Werkstücke
- Schmiedeteile
- Mehrkantprofile
- Schweißdurchmesser von 8 bis 80 mm (Querschnitte von 50 bis 5.026 mm<sup>2</sup>)
- in Sonderfällen bis 6.000 mm Länge

Unsere Kernkompetenz liegt in der Bearbeitung von HSS-Werkzeugen.

Bitte sprechen Sie uns an:

**Schweißtechnik Remscheid GmbH & Co. KG**

Auf dem Knapp 34, 42855 Remscheid

Telefon: 0 21 91 / 3 78 28, Telefax: 0 21 91 / 3 78 74

E-mail: schweisstechnik-rs@t-online.de



Dieser Katalog informiert Sie über den HAHNREITER Produktbereich Gewindetechnik. Im Einzelnen finden Sie:

**Gewindebohrer und Gewindeformer**  
**Schneideisen**  
**Lehren**

Wir beraten Sie kompetent und objektiv bei der Lösung Ihrer Aufgaben rund um das Thema Gewindefertigung. Unsere Mitarbeiter im Innen- und Außendienst stehen Ihnen gerne zur Verfügung.

Im technischen Teil dieses Kataloges finden Sie umfangreiche Informationen zu den Themen Gewinde, Werkstoffe und Werkzeugtechnik.

*This catalogue will inform you about HAHNREITER Threading products. You will find following products:*

***Taps and Cold Forming Taps***  
***Dies***  
***Gauges***

*We will competently support you solving your threading problems. Our qualified staff will be glad to assist you.*

*In the technical part of the catalogue you will find a lot of information about threads, materials and tooling technology.*

Unsere für Sie zuständige Vertretung siehe Rückseite  
*Our representative for your area see rear page*

**Made in  
GERMANY  
seit 1867**

**HAHNREITER**  
**GEWINDETECHNIK**

**Wilh. Becker GmbH & Co. KG · Hahnreiter Gewindetechnik**

Auf dem Knapp 34    Telefon: +49 2191 378-0    E-mail: [info@hahnreiter.de](mailto:info@hahnreiter.de)  
D-42855 Remscheid    Telefax: +49 2191 378-78    Internet: [www.hahnreiter.de](http://www.hahnreiter.de)



Wilh. Becker  
Werkzeug Fabrik  
Remscheid  
Wilh. Becker  
tool maker com-  
pany, Remscheid



„Hahnreiter“ PRÄZISION

Das neue Gebäude  
„Auf dem Knapp 34“  
The new building  
"Auf dem Knapp 34"

# HAHNREITER GEWINDETECHNIK

## seit 150 Jahren mit Gewinden verbunden

Die Remscheider Firma Wilhelm Becker ist tief verwurzelt im Bergischen Land, einer wichtigen Industrieregion zwischen Köln und dem Ruhrgebiet. Das kompromisslose Engagement eines mittelständischen Familienunternehmens und die hohe Einsatzbereitschaft erfahrener Mitarbeiter bilden seit 150 Jahren die Basis für innovative, zuverlässige Qualitätswerkzeuge „Made in Germany“.

In den 30er Jahren des 19. Jahrhunderts begann Johann Daniel Becker mit der Herstellung von Schrauben und Gewindebohrern. Seit 1867 heißt die Firma „Wilh. Becker - Werkzeugfabrik“. Nach dem zweiten Weltkrieg baute Gottlieb Wilhelm Becker den zerstörten Betrieb in der Kronprinzenstraße mit nur einem Mitarbeiter wieder auf und begann auf 200 m<sup>2</sup> erneut mit der Produktion von Gewindebohren.

Durch den Zusammenschluss mit dem Handelsunternehmen „Ernst Birgden HAHNREITER Präzision“ von Lothar Härtel im Jahre 1974 erhielt die Firma Wilh. Becker ihren mittlerweile weltbekanntesten Markennamen „HAHNREITER“.

1990 wurde die Produktion in das neue Industriegebiet „Auf dem Knapp“ verlagert. Von anfänglichen 1.800 m<sup>2</sup> wuchs die Produktionsfläche durch zwei Erweiterungsbauten auf nunmehr 3.450 m<sup>2</sup>. Durch den Umzug von Verwaltung und Fertiglager in ein neues modernes Gebäude am Produktionsstandort im Jahr 2014 konnten die Arbeitsabläufe weiter optimiert werden.

Das Unternehmen, das nun in der sechsten Generation von der Familie Becker geführt wird, firmiert seit 2015 als „Wilh. Becker GmbH & Co.KG HAHNREITER Gewindetechnik“. Die Einführung eines neuen Firmenlogos spiegelt die moderne Ausrichtung des heutigen Unternehmens wider.

Seit vielen Jahren bietet die Fa. Wilh. Becker Dienstleistungen im Bereich verschiedener Schleiftechnologien an. Im Jahr 2012 wurde die Firma Schweißtechnik Remscheid GmbH & Co.KG gegründet, die Reib- und Abbrennstumpfschweißarbeiten im Lohn durchführt. Die Firma, die auch von den Brüdern Ferdinand Wilhelm und Christian Becker geleitet wird, ist ebenfalls auf dem Gelände „Auf dem Knapp 34“ angesiedelt.





## Connected to Threads since 150 Years

*Wilhelm Becker is deeply rooted in Remscheid one of the three major towns in the "Bergisches Land" region located between Cologne and the Ruhrgebiet. The sincere engagement of a family owned middle size company and high commitment of experienced employees are the basis for innovative reliable quality tools since 150 years.*

*In the 30<sup>th</sup> of the 19<sup>th</sup> century Johann Daniel Becker started the production of screws and taps. In 1867 the company "Wilh. Becker Tool Maker Company" was officially established. After Second World War Gottlieb Wilhelm Becker restarted production with one employee*

*in a factory of only 200 m<sup>2</sup> in Remscheid's Kronprinzen-Street. In 1974 the company merged with the trading company "Ernst Birgden - HAHNREITER precision tools" of Mr. Lothar HärteI. Since that time "HAHNREITER" brand name becomes well known all over the world*

*In 1990 production was moved to the new facility "Auf dem Knapp". The factory hall 1,800 m<sup>2</sup> big was enlarged twice to now 3,450m<sup>2</sup>. In 2014 office and stock moved to a new erected building on the same plot, now concentrating all the business in one unit which helps to further optimize the company's workflow.*

*The company being led by the Becker family in the sixth generation is named "Wilh. Becker GmbH & Co.KG - HAHNREITER Gewindetechnik" since 2015. The introduction of a new company logo underlines its modern orientation.*

*Since many years Wilh. Becker offers services in different fields of grinding technologies. In 2012 company "Schweiss-technik Remscheid GmbH & Co KG" was established, offering services for friction welding and flash butt welding. This company as well being managed by Ferdinand Wilhelm and Christian Becker is located "Auf dem Knapp 34" as well.*







## Das Besondere daran ist wie's gemacht wird

In mehr als 40 Ländern weltweit wird auf Qualität und Leistungsfähigkeit von HAHNREITER Gewindewerkzeugen vertraut.

Unsere Kunden werden durch immer anspruchsvollere Werkstoffe und Werkstücke ständig vor neue Zerspanungsaufgaben gestellt. HAHNREITER unterstützt seine Kunden durch ein kontinuierlich wachsendes Spektrum innovativer Gewindewerkzeuge. Neue Produkte werden als eine Kombination aus optimierten Zerspanungsgeometrien, Werkstoffen, Wärmebehandlungen und Beschichtungen entwickelt. Für unsere Kunden bevorraten wir mehr als 70 verschiedene Geometrietypen in den unterschiedlichsten Gewindearten und Toleranzlagen. Sonderwerkzeuflösungen ergänzen das Spektrum auch bei außergewöhnlichen Werkzeuganforderungen. Unser großer Maschinenpark erlaubt sowohl die wirtschaftliche Fertigung großer Fertigungslose als auch die Fertigung von Sonderlösungen bis zur Losgröße „Eins“.

Der weltweite Erfolg von HAHNREITER Gewindewerkzeugen basiert auf einer konsequenten Qualitätsphilosophie. Den Ausgangspunkt bildet der chargenreine Einsatz hochwertiger, auf den Einsatzfall des Werkzeugs abgestimmter Schnellarbeitsstähle. Die bedarfsgerechte Wärmebehandlung erfolgt in modernen Vakuum- und Salzbadhärteanlagen. Für die Schleifprozesse stehen überwiegend vollautomatisierte Schleifmaschinen der neuesten Generation für alle Arbeitsgänge zur Verfügung. Der Einsatz hochgenauer Messtechnik ermöglicht die Kontrolle und Dokumentation der gewünschten Arbeitsergebnisse.

Auf unseren hauseigenen Versuchsanlagen müssen neu entwickelte Geometrien ihre Praxistauglichkeit beweisen. Genauso zeigen hier Produkte aus unserer laufenden Fertigung immer wieder, dass sie den Anforderungen unserer Kunden entsprechen.







## The Secret is how it was made

*Customers in more than 40 countries all over the world trust in quality and efficiency of HAHNREITER threading tools.*

*Applications become more and more challenging in regard to material and components which have to be machined. HAHNREITER supports their customers by supplying a continuously rising range of innovative threading tools. New tools are being developed as a combination of optimized tool geometries and choice of material, heat treatment and coating. Our customers may choose amongst more than 70 different types of tools being offered in various threads and tolerances. The range is completed by special tool solutions even in case of extraordinary requirements. Our wide range of grinding machines enable a high efficient production of big batches as well as the manufacturing of special solutions down to batch size one.*

*The worldwide success of HAHNREITER threading tools is based on a strict quality philosophy. Starting point is the use of appropriate high quality speed steels. The customized heat treatment is carried out in modern vacuum and salt bath furnaces. The various grinding operations are carried out on mostly full automatic state of the art grinding machines. The use of high accurate measuring technology enables the control and documentation of desired results.*

*On our in house testing facilities new designed products have to show their suitability for customer's use as well as tools from routine production consistently have to prove their ability to suit customer's requirements.*



## Bitte beachten

Die Toleranzen des Gewindeteils der Gewindebohrer für metrische ISO Gewinde werden mit den Toleranzklassen gemäß DIN-EN 22857 bezeichnet. Da in der Praxis die Bezeichnungen der zurückgezogenen Norm DIN 802 Teil 1 noch sehr gebräuchlich sind, werden unsere Gewindebohrer mit beiden Toleranzangaben beschriftet.

Wir fertigen unsere Gewindewerkzeuge nach DIN 2197 (Technische Lieferbedingungen für Gewindebohrer) und DIN 2175 (Technische Lieferbedingungen für Gewindeformer).

Die Baumaße unserer Gewindebohrer entsprechen den im Katalog angegebenen Baumaßnormen. Für solche Werkzeuge, die in keiner Baumaßnorm gesondert geregelt sind, verwenden wir Baumaße gemäß dem in DIN 2184 festgelegten Generalplan (DIN 2184-1 Lange Ausführung; DIN 2184-2 Kurze Ausführung). Wir behalten uns vor, in Ausnahmefällen, abhängig von der Verfügbarkeit von Rohlingen, von den Baumaßnormen abzuweichen. Hierdurch kann es zu Abweichungen von den abgedruckten Baumaßen kommen.

Die in diesem Katalog dargestellten technischen Daten wurden mit großer Sorgfalt zusammengetragen. Eventuelle Fehler oder zwischenzeitlich eingetretene Änderungen berechtigen zu keinerlei Ansprüchen. Alle Angaben, Abbildungen und Maße können sich infolge technischer Weiterentwicklung ändern. Sie sind daher nicht verbindlich. Angaben über die Eignung zu bestimmten Einsatzzwecken dienen nur der Produktbeschreibung. Ansprüche können daraus nicht abgeleitet werden. Die Verantwortung für den sachgerechten Einsatz unserer Produkte obliegt dem Anwender.

Die Preise entnehmen Sie bitte unserer separaten, aktuellen Preisliste.

Die Verwendung von Texten und Bildern aus diesem Katalog, auch auszugsweise, ist ohne unsere Genehmigung nicht gestattet.

Unsere allgemeinen Geschäftsbedingungen finden Sie auf den letzten Seiten dieses Katalogs.

## For your attention

*The tolerance classes for ISO metric taps will be specified according to DIN EN 22857. As the tolerance classes of the superseded standard DIN 802 part 1 are still very common, we mark our taps with both tolerances.*

*We produce our taps according to DIN 2197 (technical specifications for taps) and DIN 2175 (technical specifications for cold forming taps)*

*The dimensions of our taps correspond to the printed dimension standard of this catalogue. For those tools, which are not designated in separate dimension standards, we follow the general plans according to DIN 2184 (DIN 2184-1 long type DIN 2184-2 short type). We subject to exceptional modifications depending on availability of blanks. This may lead to small deviations to the printed dimensions.*

*The data of this catalogue has been assembled with great care. Mistakes or meanwhile changes do not entitle to any claims. All details, pictures, sizes and dimensions can change due to technical progress and are without obligation. Informations about the use for special purposes are just for description of the products without any obligation. The user is responsible for the appropriate use of our tools.*

*Please find the prices in our separate current pricelist*

*The use of text and pictures contained in this catalogue is not allowed without our approval.*

*You can find our general delivery conditions on the last pages of this catalogue.*



**Gewindebohrer / Gewindeformer  
Verlängerungen**

**G0 - G123  
G124 - G125**

**Taps / Cold Forming Taps  
Extensions**

**G0 - G123  
G124 - G125**

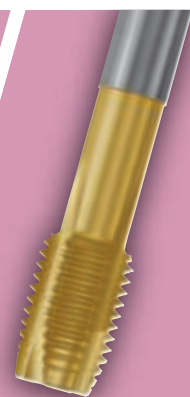

**Schneideisen**

**S0 - S29**

**Dies**

**S0 - S29**

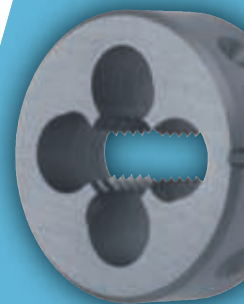

**Lehren**

**L0 - L24**

**Gauges**

**L0 - L24**



**Technischer Teil / Sonstiges**

**T1 - T59**

**Technical Index / Others**

**T1 - T59**

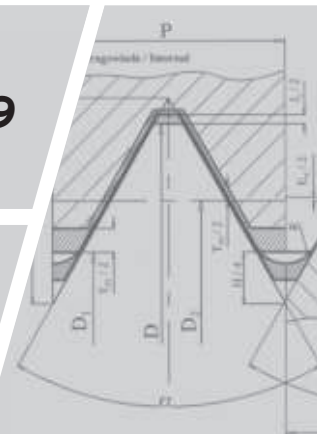

# Gewindebohrer / Gewindeformer

	Seite
<b>Der Weg zum richtigen Gewindebohrer / Gewindeformer</b>	<b>13</b>
<b>Anwendungstabelle</b>	<b>15 - 18</b>
<b>Finder (Typenaufstellung)</b>	<b>20 - 31</b>
<b>M</b>	
<b>Metrisches ISO-Regelgewinde DIN 13</b>	
Handgewindebohrer	<b>G0 - G5</b>
Automaten-Gewindebohrer	<b>G6 - G8</b>
Maschinen-Gewindebohrer, Baumaße ISO529/DIN 352, kurze Ausführung	<b>G9 - G10</b>
Maschinen-Gewindebohrer, Baumaße DIN 371, verstärkter Schaft	<b>G11 - G21</b>
Maschinen-Gewindebohrer, Baumaße DIN 376, Überlaufschaft	<b>G22 - G29</b>
Maschinen-Gewindebohrer, SYNC Type	<b>G30 - G31</b>
Maschinen-Gewindebohrer mit Kühlmittelbohrung	<b>G32 - G35</b>
Maschinen-Gewindebohrer mit überlangem Schaft	<b>G36 - G37</b>
Maschinen-Mutter-Gewindebohrer	<b>G38 - G39</b>
Maschinen-Gewindeformer, Baumaße DIN 2174 (371), verstärkter Schaft	<b>G40 - G41</b>
Maschinen-Gewindeformer, Baumaße DIN 2174 (376), Überlaufschaft	<b>G42 - G43</b>
<b>EG-M</b>	
<b>Metrisches ISO-Regelgewinde für Draht-Gewindeeinsätze</b>	
Maschinen-Gewindebohrer, Baumaße DIN 2184-1 (371), verstärkter Schaft	<b>G44</b>
Maschinen-Gewindebohrer, Baumaße DIN 2184-1 (376), Überlaufschaft	<b>G45</b>
<b>MF</b>	
<b>Metrisches ISO Feingewinde DIN 13</b>	
Handgewindebohrer	<b>G46 - G49</b>
Handgewindebohrer für Elektroinstallationsrohre DIN EN 60423	<b>G50</b>
Automaten-Gewindebohrer	<b>G51 - G53</b>
Maschinen-Gewindebohrer, Baumaße DIN 371, verstärkter Schaft	<b>G54 - G55</b>
Maschinen-Gewindebohrer, Baumaße DIN 374, Überlaufschaft	<b>G56 - G64</b>
Maschinen-Gewindebohrer mit axialer Kühlmittelbohrung	<b>G65</b>
Maschinen-Gewindeformer, Baumaße DIN 2174 (374), Überlaufschaft	<b>G66</b>
<b>UNC</b>	
<b>Unified Grobgewinde ANSI B 1.1</b>	
Handgewindebohrer	<b>G68</b>
Maschinen-Gewindebohrer, Baumaße DIN 2184-1 (371), verstärkter Schaft	<b>G69 - G73</b>
Maschinen-Gewindebohrer, Baumaße DIN 2184-1 (376), Überlaufschaft	<b>G74 - G77</b>
Automaten-Gewindebohrer	<b>G78</b>
Maschinen-Gewindeformer, Baumaße DIN 2184-1	<b>G79</b>
<b>EG-UNC</b>	
<b>Unified Grobgewinde für Draht-Gewindeeinsätze NASM 33537</b>	
Maschinen-Gewindebohrer, Baumaße DIN 2184-1	<b>G80</b>
<b>UNF</b>	
<b>Unified Feingewinde ANSI B1.1</b>	
Handgewindebohrer	<b>G81</b>
Automaten-Gewindebohrer	<b>G82</b>
Maschinen-Gewindebohrer, Baumaße DIN 2184-1 (371), verstärkter Schaft	<b>G83 - G87</b>
Maschinen-Gewindebohrer, Baumaße DIN 2184-1 (374), Überlaufschaft	<b>G88 - G91</b>
Maschinen-Gewindeformer, Baumaße DIN 2184-1	<b>G92</b>
<b>EG-UNF</b>	
<b>Unified Feingewinde für Draht-Gewindeeinsätze NASM 33537</b>	
Maschinen-Gewindebohrer, Baumaße DIN 2184-1	<b>G93</b>



# Gewindebohrer / Gewindeformer

		Seite
<b>UN</b>	<b>Unified Gewinde 8 Gang Reihe ANSI B1.1</b> Maschinen-Gewindebohrer, Baumaße DIN 2184-1 (376), Überlaufschaft	G94
<b>G</b>	<b>Whitworth Rohrgewinde DIN ISO 228</b> Handgewindebohrer Automaten-Gewindebohrer Maschinen-Gewindebohrer, Baumaße DIN 5157, kurze Ausführung Maschinen-Gewindebohrer, Baumaße DIN 5156, Überlaufschaft Maschinen-Gewindeformer, Baumaße DIN 5156, Überlaufschaft	G95 G96 - G98 G99 G100 - 103 G104
<b>Rp</b>	<b>Whitworth Rohrgewinde DIN EN 10226-1, ISO 7, (DIN 2999 zurückgezogen)</b> Automaten-Gewindebohrer Maschinen-Gewindebohrer, Baumaße DIN 5156, Überlaufschaft	G105 G106 - G107
<b>Rc</b> (alt: BSPT)	<b>Kegeliges Whitworth Rohrgewinde DIN EN 10226-2 / ISO 7</b> Maschinen-Gewindebohrer, Baumaße DIN 5156 Überlaufschaft	G108
<b>NPT</b>	<b>Amerikanisches Kegeliges Rohrgewinde - Konus 1 : 16 nach ANSI B 1.20.1 „allgemeine Verwendung“</b> Maschinen-Gewindebohrer, Baumaße Werksnorm, kurze Ausführung Maschinen-Gewindebohrer, Baumaße ≈ DIN 5156, Überlaufschaft	G109 G110 - G111
<b>NPTF</b>	<b>Amerikanisches Kegeliges Rohrgewinde - Konus 1 : 16 nach ANSI B 1.20.3 „trocken dichtend“</b> Maschinen-Gewindebohrer, Baumaße Werksnorm, kurze Ausführung Maschinen-Gewindebohrer, Baumaße ≈ DIN 5156, Überlaufschaft	G112 G113
<b>Pg</b>	<b>Stahlpanzerrohr-Gewinde, DIN 40430 (zurückgezogen, durch MF-Gewinde gemäß DIN EN 60423 ersetzt)</b> Handgewindebohrer Maschinen-Gewindebohrer, Baumaße DIN 40433, Überlaufschaft Automaten-Gewindebohrer	G114 G115 G115
<b>BSW</b>	<b>Whitworth Grobgewinde, BS 84</b> Handgewindebohrer Maschinen-Gewindebohrer, Baumaße DIN 2184-1 (371), verstärkter Schaft Maschinen-Gewindebohrer, Baumaße DIN 2184-1 (376), Überlaufschaft	G116 G117 G118
<b>Rd</b>	<b>Rundgewinde DIN 405</b> Automaten-Gewindebohrer	G119
<b>Tr</b>	<b>Metrisches ISO Trapezgewinde, DIN 103</b> Trapez Satz-Gewindebohrer, Baumaße Werksnorm Trapez Einschnitt-Gewindebohrer, mit Vorschneidstufe Automaten-Gewindebohrer  <b>Gewindebohrer-Verlängerungen</b> <b>Sondergewindebohrer</b>	G120 - G121 G122 G123  G124 - G125 G126 - G127

# Taps / Cold Forming Taps

	<b>Page</b>
<b>How to find the right tap</b>	<b>13</b>
<b>Selector Chart</b>	<b>15 - 18</b>
<b>Finder (List of types)</b>	<b>20 - 31</b>
<b>M</b>	
<b>ISO Metric Coarse Threads, DIN 13</b>	
Hand Taps	<b>G0 - G5</b>
Taps for Automatic Lathes	<b>G6 - G8</b>
Machine Taps, Dimensions ISO529/DIN 352, Short type	<b>G9 - G10</b>
Machine Taps, Dimensions DIN 371, Reinforced shank	<b>G11 - G21</b>
Machine Taps, Dimensions DIN 376, Reduced shank	<b>G22 - G29</b>
Machine Taps, SYNC type	<b>G30 - G31</b>
Machine Taps with internal coolant supply	<b>G32 - G35</b>
Machine Taps with extra long shanks	<b>G36 - G37</b>
Machine Nut Taps	<b>G38 - G39</b>
Cold Forming Taps, Dimensions DIN 2174 (371), Reinforced shank	<b>G40 - G41</b>
Cold Forming Taps, Dimensions DIN 2174 (376), Reduced shank	<b>G42 - G43</b>
<b>EG-M</b>	
<b>ISO Metric Coarse Threads for wire inserts</b>	
Machine Taps, Dimensions DIN 2184-1 (371), Reinforced shank	<b>G44</b>
Machine Taps, Dimensions DIN 2184-1 (376), Reduced shank	<b>G44</b>
<b>MF</b>	
<b>ISO Metric Fine Threads, DIN 13</b>	
Hand Taps	<b>G46 - G49</b>
Hand Taps for Conduits and Fittings DIN EN 60423	<b>G50</b>
Taps for Automatic Lathes	<b>G51 - G53</b>
Machine Taps, Dimensions DIN 371, Reinforced shank	<b>G54 - G55</b>
Machine Taps, Dimensions DIN 374, Reduced shank	<b>G56 - G64</b>
Machine Taps with internal coolant supply, axial	<b>G65</b>
Cold Forming Taps, Dimensions DIN 2174 (374), Reduced shank	<b>G66</b>
<b>UNC</b>	
<b>Unified Coarse Threads ANSI B 1.1</b>	
Hand Taps	<b>G68</b>
Machine Taps, Dimensions DIN 2184-1 (371), Reinforced shank	<b>G69 - G73</b>
Machine Taps, Dimensions DIN 2184-1 (376), Reduced shank	<b>G74 - G77</b>
Taps for Automatic Lathes	<b>G78</b>
Cold forming Taps, Dimensions DIN 2184-1	<b>G79</b>
<b>EG-UNC</b>	
<b>Unified Coarse Threads for wire inserts NASM 33537</b>	
Machine Taps, Dimensions DIN 2184-1	<b>G80</b>
<b>UNF</b>	
<b>Unified Fine Threads ANSI B 1.1</b>	
Hand Taps	<b>G81</b>
Taps for Automatic Lathes	<b>G82</b>
Machine Taps, Dimensions DIN 2184-1 (371), Reinforced shank	<b>G83 - G87</b>
Machine Taps, Dimensions DIN 2184-1 (374), Reduced shank	<b>G88 - G91</b>
Cold forming Taps, Dimensions DIN 2184-1	<b>G92</b>
<b>EG-UNF</b>	
<b>Unified Fine Threads for wire inserts NASM 33537</b>	
Machine Taps, Dimensions DIN 2184-1	<b>G93</b>



# Taps / Cold Forming Taps

Page

<b>UN</b>	<b>Unified Threads 8 TPI Series ANSI B 1.1</b> Machine Taps, Dimensions DIN 2184-1 (374), Reduced shank	<b>G94</b>
<b>G</b>	<b>Whitworth Pipe Threads DIN ISO 228</b> Hand Taps Taps for Automatic Lathes Machine Taps, Dimensions DIN 5157, Short Taps Machine Taps, Dimensions DIN 5156, Reduced shank Cold Forming Taps, Dimensions DIN 5156, Reduced shank	<b>G95</b> <b>G96 - G98</b> <b>G99</b> <b>G100 - G103</b> <b>G104</b>
<b>Rp</b>	<b>Whitworth Pipe Threads DIN EN 10226, ISO 7, (DIN 2999 withdrawn)</b> Taps for Automatic Lathes Machine Taps, Dimensions DIN 5156, Reduced shank	<b>G105</b> <b>G106 - G107</b>
<b>Rc</b> (old: BSPT)	<b>Whitworth Pipe Threads Taper DIN EN 10226-1 / ISO 7</b> Machine taps, dimensions DIN 5156, reduced shank	<b>G108</b>
<b>NPT</b>	<b>American Taper Pipe Thread - Taper 1 : 16</b> <b>accord. to ANSI B 1.20.1 "general purpose"</b> Machine Taps, Dimensions manufacturer's standard, Short Taps Machine Taps, Dimensions ≈ DIN 5156, Reduced shank	<b>G109</b> <b>G110 - G111</b>
<b>NPTF</b>	<b>American Taper Pipe Thread - Taper 1 : 16</b> <b>accord. to ANSI B 1.20.3 "dry sealing"</b> Machine Taps, Dimensions manufacturer's standard, Short Taps Machine Taps, Dimensions ≈ DIN 5156, Reduced shank	<b>G112</b> <b>G113</b>
<b>Pg</b>	<b>Steel Conduit Thread, DIN 40430 (withdrawn, replaced</b> <b>by MF-Thread according to DIN EN 60423)</b> Hand Taps Machine Taps, Dimensions DIN 40433, Reduced shank Taps for Automatic Lathes	<b>G114</b> <b>G115</b> <b>G115</b>
<b>BSW</b>	<b>Whitworth Coarse Threads BS 84</b> Hand Taps Machine Taps, Dimensions DIN 2184-1 (371), Reinforced shank Machine Taps, Dimensions DIN 2184-1 (376), Reduced shank	<b>G116</b> <b>G117</b> <b>G118</b>
<b>Rd</b>	<b>Round Threads DIN 405</b> Taps for Automatic Lathes	<b>G119</b>
<b>Tr</b>	<b>Metric ISO Trapeziodal Threads DIN 103</b> Set of Trapeziodal Taps, Dimensions manufacturer's standard Trapeziodal Single Finishing Taps, Dim. manufacturer's standard, 2 steps Taps for Automatic Lathes  Tap Extensions  Special Taps	<b>G120 - G121</b> <b>G122</b> <b>G123</b>  <b>G124 - G125</b>  <b>G126 - G127</b>

**HAHNREITER**  
GEWINDETECHNIK

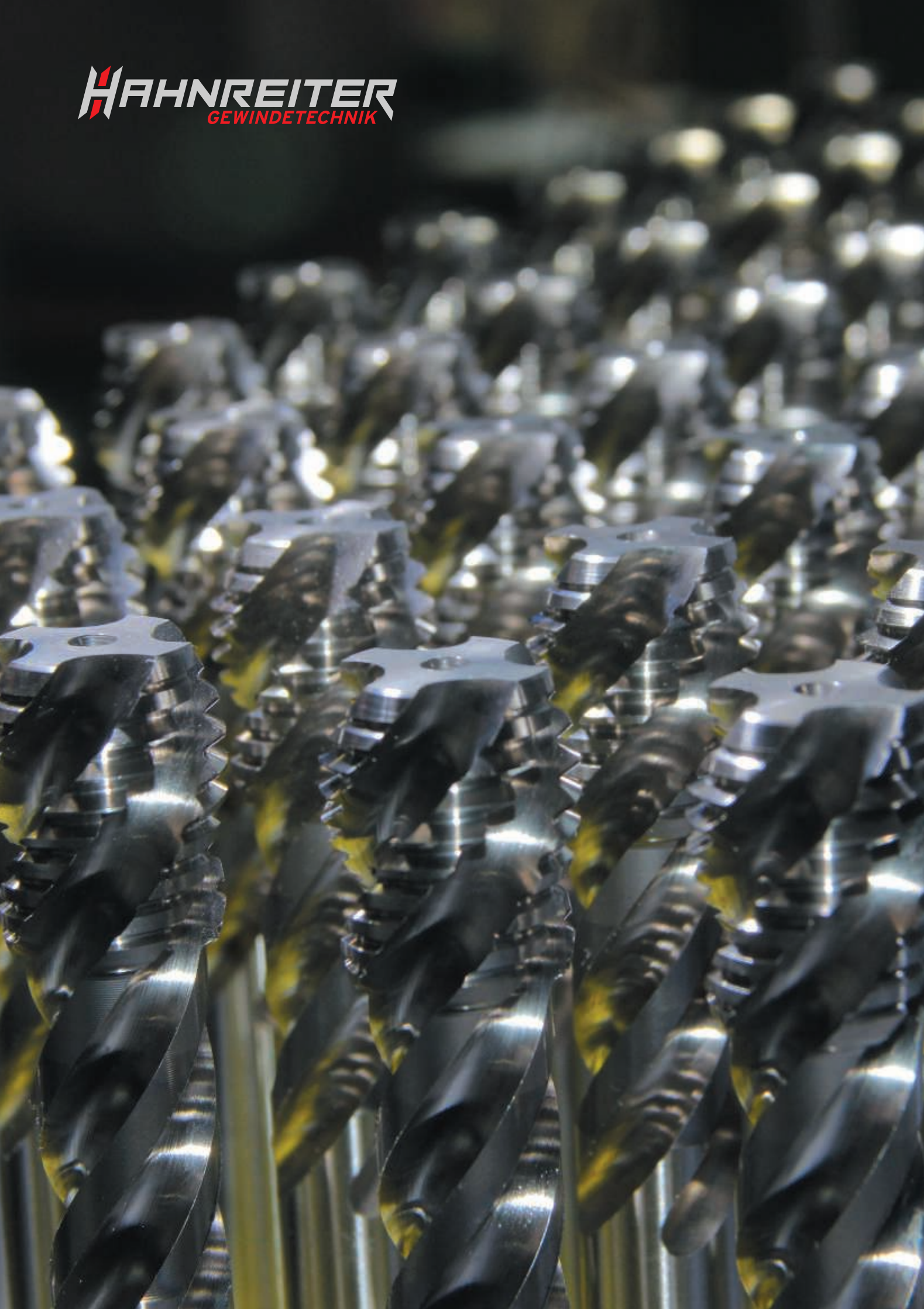



## Der Weg zum richtigen Gewindebohrer

1. Zu bearbeitenden Werkstoff in der Werkstofftabelle ab Seite T29 einer Zerspanungsgruppe zuordnen
2. In der Anwendungstabelle Seite 15 geeigneten Gewindebohrertyp / Gewindeformertyp ermitteln
3. Im „Finder“ ab Seite 20 finden Sie die den Baumaßen und der Gewindeart entsprechenden Seitenzahlen
4. Auf den angegebenen Seiten sind Abbildung, Baumaße, Beschreibung und Verfügbarkeit aufgeführt
5. Preise entnehmen Sie bitte der jeweils gültigen separaten Preisliste

## How to find the right tap

1. Please relate the working-material to a machinability-group, see list of materials from page T29
2. Determine suitable type of tap or cold forming tap in the selector chart on page 15
3. The 'Finder' on page 20 will lead you to the right page-no. depending on dimension and type of thread
4. On this page you will find picture, dimensions, description and availability
5. For prices please see current price list

## Anwendungstabelle - Gewindebohrer / Gewindeformer Selector Chart - Taps / Cold Forming Taps

siehe Rückseite = Ausklappseite

see back page = open out page









Spiralo 35 TS	Spiralo 35 VAP	Spiralo 35 VS	Spiralo 35 Z	Spiralo 40 SYNC	Spiralo 45	Spiralo 45 ZB	Spiralo 48 TS TiN	Standfest 0	Standfest 2	Standfest 3	2-Flach	Drückfix IKZ TiN	Drückfix N CrB2	Drückfix N HF TiN	Drückfix N TiCN	Drückfix N TiN	Drückfix TiN	ISO-Code	Material-Hauptgruppe Maingroup	
TS	S	S	S	S	S	TS	TS	FD	FD	FD	TS	S	D S	D S	D S	D S	FD FS			
☺	☺		☺	☺		☺	☺	☺	☺	☺		☺		☺		☺	☺		<b>P</b>	<b>Stahl</b> <i>Steel</i>
☺		○	☺	☺		☺	☺	☺	☺	☺		☺		☺		☺	☺			
☺		○	☺	☺		☺	☺	☺	☺	☺		☺		☺		☺	☺			
☺		○	☺	☺		☺	☺	☺	☺	☺		☺		☺		☺	☺			
☺		○	☺	☺		☺	☺	☺	☺	☺		☺		☺		☺	☺			
☺		○	☺	☺		☺	☺	☺	☺	☺		☺		☺		☺	☺			
☺		○	☺	☺		☺	☺	☺	☺	☺		☺		☺		☺	☺			
☺		○	☺	☺		☺	☺	☺	☺	☺		☺		☺		☺	☺			
☺		○	☺	☺		☺	☺	☺	☺	☺		☺		☺		☺	☺			
☺		○	☺	☺		☺	☺	☺	☺	☺		☺		☺		☺	☺			
		○		○												☺	○		<b>M</b>	<b>rostfreier Stahl</b> <i>Stainless steel</i>
		○		○												☺	○			
		z○		○															<b>K</b>	<b>Gusseisen</b> <i>Cast iron</i>
		z○		○																
			○	○	○							☺	☺						<b>N</b>	<b>Kupferlegierungen</b> <i>Copper alloys</i>
		☺	○	○								☺	☺							
			○	○	☺								☺							
			○	○																
		☺	○	○																
○			☺	○									○						<b>N</b>	<b>Leichtmetall-Legierungen</b> <i>Light metal alloys</i>
				○																
		☺		○																
			○	○																
				○															<b>S</b>	<b>Sonderlegierungen</b> <i>Special alloys</i>

S = Blind hole > 1xD  
 TS = Deep blind hole > 2xD



















☺ = bevorzugt geeignet ☺ = most suitable  
 ○ = geeignet ○ = suitable

N = Oberflächenbehandlung 'NIT' empfehlenswert  
 N = Surface treatment 'NIT' is recommended



**HAHNREITER**  
GEWINDETECHNIK



<b>FINDER</b>		Gewinde / Thread:	M	EG-M	MF	
Gewindebohrer / Gewindeformer Taps / Cold Forming Taps		Typ Type	Katalog-Nr. Catalogue-No.	110...	133...	111...
<b>Handgewindebohrer</b> <i>Hand taps</i>						
	<b>Hahnreiter</b>	... div.	G0		G46	
	<b>Hahnreiter LH</b>	... 010 ... 070	G3		G46	
	<b>Nirofix</b>	... 040 ... 050 ... 080	G4		G49	
<b>Extra kurze Automatengewindebohrer</b> <i>Extra short taps for automatic lathes</i>						
	<b>2-Flach</b>	... 685	G9			
	<b>2-Flach 6G</b>	... 686	G9			
	<b>Automat</b>	... 620				
	<b>Automat 15</b>	... 605	G6		G51	
	<b>Automat 15 6G/+0,05</b>	... 606	G6		G51	
	<b>Automat 20</b>	... 607	G7		G53	
	<b>Automat 20 6G/+0,05</b>	... 608	G7		G53	
	<b>Automat 20 +0,1</b>	... 609	G7		G53	
	<b>Automat 20 MS-Z</b>	... 619	G7		G52	
	<b>Automat 20 MS-Z 6G/+0,05</b>	... 611	G7		G52	
	<b>Automat 20 MS-Z +0,1</b>	... 612	G7		G52	
	<b>Automat 20 Sty</b>	... 616	G7		G53	
	<b>Automat 20 Sty 6G/+0,05</b>	... 617	G7		G53	
	<b>Automat 20 Sty +0,1</b>	... 618	G7		G53	
	<b>Automat 20 TiN</b>	... 613	G8		G53	
	<b>Automat 20 TiN 6G/+0,05</b>	... 614	G8		G53	

UNC	EG-UNC	UNF	EG-UNF	UN	G	Rp	Rc	NPT	NPTF	Pg	BSW	Rd	Tr
112...	135..	113...	136..	127...	114...	123...	124...	117...	118...	119...	115...	122...	121...

Katalog Seite / Catalogue page





G68		G81			G95					G114	G116		G120
													G121

												G119	
					G96								
					G96								
G78		G82			G97								
					G97								
					G97								
G78		G82			G97								
					G97								
					G97								
G78		G82			G97								
					G97								
					G97								
G78		G82			G98								
					G98								



<b>FINDER</b>	Gewinde / <i>Thread:</i>	M	EG-M	MF	
Gewindebohrer / Gewindeformer <i>Taps / Cold Forming Taps</i>	Typ <i>Type</i>	Katalog-Nr. <i>Catalogue-No.</i>	110...	133...	111...

**Extra kurze Automatengewindebohrer**  
*Extra short taps for automatic lathes*





	<b>Automat 20 TiN +0,1</b>	... 615	G8		G53
	<b>Automat MS</b>	... 600	G6		G51
	<b>Automat MS 6G/ +0,05</b>	... 601	G6		G51
	<b>Automat MS +0,1</b>	... 602	G6		G51
	<b>Automat MS LH</b>	... 610			

**Kurze Maschinengewindebohrer**  
*Short machine taps*

	<b>Dulofix</b>	... 105			
	<b>Hahnreiter</b>	... 100	G10		
	<b>Hahnreiter AZ</b>	... 103			
	<b>Hahnreiter MS</b>	... 180	G10		
	<b>Hahnreiter MS +0,05</b>	... 184	G10		
	<b>Hahnreiter MS +0,1</b>	... 187			
	<b>Spiralo 15</b>	... 118	G10		
	<b>Spiralo 35</b>	... 126	G10		

**Maschinengewindebohrer**  
*Machine taps*

Verstärkter Schaft / *Reinforced shank*  
Überlaufschaft / *Following through sh.*

	<b>Dulofix</b>	... 205 ... 305	V Ü	G11 G22	G44 G45	G54 G56
	<b>Dulofix 4H</b>	... 206	V	G12		
	<b>Dulofix 6G</b>	... 207 ... 307	V Ü	G12 G23		G56
	<b>Dulofix 6G TiN</b>	... 214	V	G12		
	<b>Dulofix 7G</b>	... 208	V	G13		

UNC	EG-UNC	UNF	EG-UNF	UN	G	Rp	Rc	NPT	NPTF	Pg	BSW	Rd	Tr
112...	135..	113...	136..	127...	114...	123...	124...	117...	118...	119...	115...	122...	121...





















Katalog Seite / Catalogue page

					G98								
G78		G82			G96	G105				G115		G119	G123
					G96	G105				G115			
					G96								
												G119	G123

					G99								
								G109	G112				
								G109					
					G99								
					G99								
					G99								
					G99								

G69 G74	G80 G80	G83 G88	G93 G93		G100	G106				G115	G117 G118		

FINDER

<b>FINDER</b>		Gewinde / Thread:		M	EG-M	MF
Gewindebohrer / Gewindeformer Taps / Cold Forming Taps		Typ Type	Katalog-Nr. Catalogue-No.	110...	133...	111...
<b>Maschinengewindebohrer</b> <i>Machine taps</i>		Verstärkter Schaft / Reinforced shank Überlaufschaft / Following through sh.	V Ü			
	<b>Dulofix +0,1</b>	... 220 ... 320	V Ü	G13 G23		
	<b>Dulofix AZ</b>	... 209 ... 309	V Ü	G13 G23		
	<b>Dulofix HF</b>	... 273 ... 373	V Ü	G20 G29		G61
	<b>Dulofix HF IKZ-R TiCN</b>	... 407 ... 457	V Ü	G33 G35		
	<b>Dulofix HF TiCN</b>	... 292 ... 392	V Ü	G20 G29		G61
	<b>Dulofix LH</b>	... 212 ... 312	V Ü	G13 G23		
	<b>Dulofix Ni</b>	... 276 ... 376	V Ü	G21 G29		G61
	<b>Dulofix SYNC</b>	... 286 ... 386	V Ü	G30 G30		
	<b>Dulofix SYNC IKZ-R</b>	... 288 ... 388	V Ü	G31 G31		
	<b>Dulofix Ti</b>	... 278 ... 378	V Ü	G21 G29		
	<b>Dulofix TiCN</b>	... 295 ... 395	V Ü	G12 G23		G57
	<b>Dulofix TiN</b>	... 210 ... 310	V Ü	G11 G22		G54 G56
	<b>Dulofix VAP</b>	... 202 ... 302	V Ü	G12 G23		
	<b>Dulofix VS</b>	... 270 ... 370	V Ü	G19 G28		G59
	<b>Gussfix</b>	... 281 ... 381	V Ü	G17 G26		G59
	<b>Gussfix IKZ</b>	... 406 ... 456	V Ü	G32 G34		G65
	<b>Gussfix TiN</b>	... 282 ... 382	V Ü	G17 G26		G59
	<b>Hahnreiter</b>	... 200 ... 300	V Ü	G11 G22		G54 G56
	<b>Hahnreiter AZ</b>	... 203 ... 303	V Ü			
	<b>Hahnreiter 6G</b>	... 201 ... 301	V Ü	G11 G22		



UNC	EG-UNC	UNF	EG-UNF	UN	G	Rp	Rc	NPT	NPTF	Pg	BSW	Rd	Tr
112...	135..	113...	136..	127...	114...	123...	124...	117...	118...	119...	115...	122...	121...

Katalog Seite / Catalogue page

G73 G77		G87 G91			G103								
G73 G77		G87 G91			G103								
G73 G77		G87 G91											
G73		G87											
G69 G74		G83 G88											
G69 G74		G83 G88			G100	G106							
G72 G76		G86 G90			G103	G107							
G71 G75		G85 G89			G101			G110	G113		G117 G118		
G69 G74		G83 G88			G100	G106	G108	G110	G113	G115	G117 G118		
								G110					

<b>FINDER</b>	Gewinde / <i>Thread:</i>		M	EG-M	MF
Gewindebohrer / Gewindeformer <i>Taps / Cold Forming Taps</i>	Typ <i>Type</i>	Katalog-Nr. <i>Catalogue-No.</i>	110...	133...	111...
<b>Maschinengewindebohrer</b> <i>Machine taps</i>	Verstärkter Schaft / <i>Reinforced shank</i> Überlaufschaft / <i>Following through sh.</i>		V		
			Ü		
	<b>Hahnreiter MS</b>	... 280 ... 380	V Ü	G17 G26	G58
	<b>Hahnreiter MS 6G</b>	... 284 ... 384	V Ü	G17	G59
	<b>Hahnreiter LH</b>	... 204 ... 304	V Ü	G11 G22	G56
	<b>Hahnreiter Ni AZ</b>	... 376	Ü		
	<b>Multifix</b>	... 256 ... 356	V Ü	G19 G28	G59
	<b>Multifix 35</b>	... 257 ... 357	V Ü	G19 G28	G59
	<b>Nirofix</b>	... 260 ... 360	V Ü	G18 G27	G60
	<b>Nirofix 15</b>	... 364	Ü		
	<b>Nirofix 35</b>	... 263 ... 363	V Ü	G19 G27	G60
	<b>Nirofix 35 TiN</b>	... 267 ... 367	V Ü	G19 G27	G61
	<b>Nirofix 35 TS</b>	... 265 ... 365	V Ü	G19 G27	G60
	<b>Nirofix 48 STY/WC</b>	... 268 ... 368	V Ü	G19 G27	G61
	<b>Nirofix AZ</b>	... 261 ... 361	V Ü	G18 G27	
	<b>Nirofix TiN</b>	... 266 ... 366	V Ü	G18 G27	G60
	<b>Nirofix Z STY/WC</b>	... 269 ... 369	V Ü	G18 G27	G60
	<b>Spiralo 15</b>	... 218 ... 318	V Ü	G13 G23	G54 G57
	<b>Spiralo 15 6G</b>	... 221	V	G14	
	<b>Spiralo 15 AZ</b>	... 223 ... 323	V Ü	G14 G24	
	<b>Spiralo 15 HF TiCN</b>	... 297 ... 397	V Ü	G19 G28	
	<b>Spiralo 15 HF IKZ TiCN</b>	... 408 ... 458	V Ü	G33 G35	

UNC	EG-UNC	UNF	EG-UNF	UN	G	Rp	Rc	NPT	NPTF	Pg	BSW	Rd	Tr
112...	135..	113...	136..	127...	114...	123...	124...	117...	118...	119...	115...	122...	121...

Katalog Seite / Catalogue page

					G101								
									G111				
G72 G77		G86 G91			G103	G107							
G72 G77		G86 G91			G103	G107							
G71 G75		G85 G89		G94	G101	G107							
									G111				
G71 G76		G85 G90		G94	G102	G107	G108	G110					
G71 G76		G85 G90			G102	G107							
G71 G76		G85 G90			G102								
G71 G75		G85 G89			G101	G107							
G71 G75		G85 G89			G101								
G70 G74		G84 G88			G100						G117 G118		



<b>FINDER</b>	Gewinde / Thread:		M	EG-M	MF
Gewindebohrer / Gewindeformer Taps / Cold Forming Taps	Typ Type	Katalog-Nr. Catalogue-No.	110...	133...	111...
<b>Maschinengewindebohrer</b> Machine taps	Verstärkter Schaft / Reinforced shank Überlaufschaft / Following through sh.		V Ü		
	<b>Spiralo 15 IKZ</b>	... 402 ... 452	V Ü	G32 G34	G65
	<b>Spiralo 15 IKZ TiN</b>	... 403 ... 453	V Ü	G32 G34	G65
	<b>Spiralo 15 Ti AZ</b>	... 291 ... 391	V Ü	G21 G29	
	<b>Spiralo 15 TiCN</b>	... 225 ... 325	V Ü	G14 G23	G57
	<b>Spiralo 15 TiN</b>	... 224 ... 324	V Ü	G13 G23	G57
	<b>Spiralo 25 Ni</b>	... 277 ... 377	V Ü	G21 G29	G61
	<b>Spiralo 25 Ti</b>	... 279 ... 379	V Ü	G21 G29	
	<b>Spiralo 35</b>	... 226 ... 326	V Ü	G14 G24	G54 G57
	<b>Spiralo 35 4H</b>	... 228	V	G15	
	<b>Spiralo 35 6G</b>	... 229 ... 329	V Ü	G15 G25	G57
	<b>Spiralo 35 6G TiN</b>	... 222	V	G15	
	<b>Spiralo 35 7G</b>	... 230	V	G15	
	<b>Spiralo 35 +0,1</b>	... 233 ... 333	V Ü	G15 G25	
	<b>Spiralo 35 AZ</b>	... 234 ... 334	V Ü	G16 G25	
	<b>Spiralo 35 E</b>	... 231 ... 331	V Ü	G15 G25	
	<b>Spiralo 35 HF</b>	... 274 ... 374	V Ü	G20 G29	G61
	<b>Spiralo 35 HF TiCN</b>	... 293 ... 393	V Ü	G20 G29	G61
	<b>Spiralo 35 IKZ</b>	... 404 ... 454	V Ü	G32 G34	G65
	<b>Spiralo 35 IKZ TiN</b>	... 405 ... 455	V Ü	G32 G34	G65
	<b>Spiralo 35 LH</b>	... 238 ... 338	V Ü	G16 G25	

















<b>FINDER</b>	Gewinde / Thread:		M	EG-M	MF
Gewindebohrer / Gewindeformer Taps / Cold Forming Taps	Typ Type	Katalog-Nr. Catalogue-No.	110...	133...	111...
<b>Maschinengewindebohrer</b> <i>Machine taps</i>	Verstärkter Schaft / Reinforced shank Überlaufschaft / Following through sh.		V Ü		
	<b>Spiralo 35 TiCN</b>	... 296 ... 396	V Ü	G15 G24	G57
	<b>Spiralo 35 TiN</b>	... 235 ... 335	V Ü	G14 G24	G55 G57
	<b>Spiralo 35 TS</b>	... 232 ... 332	V Ü	G15 G25	G57
	<b>Spiralo 35 VAP</b>	... 236 ... 336	V Ü	G15 G24	
	<b>Spiralo 35 VS</b>	... 271 ... 371	V Ü	G19 G28	G59
	<b>Spiralo 35-Z</b>	... 237	V	G17	
	<b>Spiralo 40 SYNC</b>	... 287 ... 387	V Ü	G30 G30	
	<b>Spiralo 40 SYNC IKZ</b>	... 289 ... 389	V Ü	G31 G31	
	<b>Spiralo 45</b>	... 252 ... 352	V Ü	G17 G26	G58
	<b>Spiralo 45 ZB TiN/VAP</b>	... 227 ... 327	V Ü	G16 G25	
	<b>Spiralo 48 TS TiN</b>	... 253 ... 353	V Ü	G16 G25	G58
	<b>Spiralo 48 TS TiN 6G</b>	... 254 ... 354	V Ü	G16 G25	G58
	<b>Standfest 0</b>	... 215	V	G13	
	<b>Standfest 2</b>	... 216	V	G13	
	<b>Standfest 2 6G</b>	... 219	V	G13	
	<b>Stufex 5</b>	... 510	Ü		
	<b>Stufex 5 LH</b>	... 511	Ü		
<b>Maschinengewindeformer</b> <i>Cold forming taps</i>					
	<b>Drückfix</b>	... 239 ... 339	V Ü	G40 G42	
	<b>Drückfix 6G</b>	... 240	V	G40	



UNC	EG-UNC	UNF	EG-UNF	UN	G	Rp	Rc	NPT	NPTF	Pg	BSW	Rd	Tr
112...	135..	113...	136..	127...	114...	123...	124...	117...	118...	119...	115...	122...	121...

Katalog Seite / Catalogue page

G70 G75		G84 G89											
G70 G75		G84 G89			G101	G106							
G72 G76		G86 G90			G103	G107							
G71 G75	G80 G80	G85 G89	G93 G93										
					G101								
G70 G75		G84 G89			G101								
G69		G83											
													G122
													G122

<b>FINDER</b>		Gewinde / <i>Thread:</i>		M	EG-M	MF
Gewindebohrer / Gewindeformer <i>Taps / Cold Forming Taps</i>		Typ <i>Type</i>	Katalog-Nr. <i>Catalogue-No.</i>	110...	133...	111...
<b>Maschinengewindeformer</b> <i>Cold forming taps</i>		Verstärkter Schaft / <i>Reinforced shank</i> Überlaufschaft / <i>Following through sh.</i>	V Ü			
	<b>Drückfix 6G TiN</b>	... 244 ... 344	V Ü	G41 G43		
	<b>Drückfix N</b>	... 241 ... 341	V Ü	G40 G42		
	<b>Drückfix N 6G</b>	... 242 ... 342	V Ü	G40 G42		
	<b>Drückfix N 6G TiN</b>	... 246 ... 346	V Ü	G41 G43		
	<b>Drückfix N CRB2</b>	... 248	V	G41		
	<b>Drückfix N HF TiN</b>	... 249 ... 349	V Ü	G41 G43		
	<b>Drückfix N IKZ TiN</b>	... 345	Ü	G43		
	<b>Drückfix N TiN</b>	... 245 ... 345	V Ü	G41 G43		G66
	<b>Drückfix N TiCN</b>	... 247 ... 347	V Ü	G41 G43		
	<b>Drückfix TiN</b>	... 243 ... 343	V Ü	G40 G42		
<b>Überlange Maschinengewindebohrer</b> <i>Extra long machine taps</i>		Verstärkter Schaft / <i>Reinforced shank</i> Überlaufschaft / <i>Following through sh.</i>	V Ü			
	<b>Dulofix ÜL</b>	... 530 ... 550	V Ü	G36 G37		
	<b>Gussfix ÜL</b>	... 532 ... 552	V Ü	G36 G37		
	<b>Spiralo 35 ÜL</b>	... 531 ... 551	V Ü	G36 G37		
<b>Muttergewindebohrer</b> <i>Nut taps</i>						
	<b>Hahnreiter</b>	... 500	Ü	G38		



M

Metrisches ISO-Regelgewinde DIN 13

Baumaße DIN 352, Satz à 3 Stück

ISO Metric Coarse Threads, DIN 13

Dimensions DIN 352, Set of 3 pieces

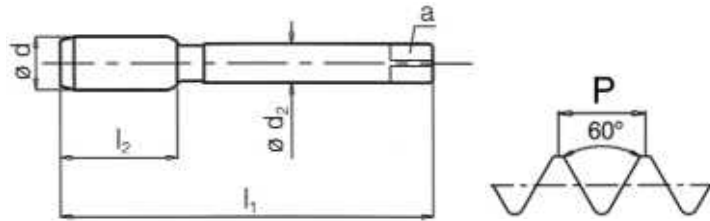

Katalog Nr. Bezeichnung	Catalogue No. Name	110 001 Hahnreiter	110 021 Hahnreiter	110 002 Hahnreiter	110 003 Hahnreiter				
Toleranz	Tolerance	Nr. 1	Nr. 1	Nr. 2	6H / ISO2				
Anschnittform	Chamfer form	5	Zapfen/Pilot 5	3-4	2-3				
Anschnittlänge, Gang für Bohrungsart	Chamfer length, threads For holes								
hauptsächlichliches Einsatzgebiet	Main use	alle gut spanbaren Materialien bis 800 N/mm <sup>2</sup> all free machining materials up to 800 N/mm <sup>2</sup>							
Zerspanungsgruppe, siehe Ausklappseite links	Machinability-group, See folder left page								
Ausführung	Variation	Vorschneider Taper	Vorschneider mit Führungszapfen Taper with Pilot	Mittelschneider Second	Fertigschneider Bottoming				
Oberfläche	Surface								
d	P mm	Code	l <sub>1</sub>	l <sub>2</sub>	l <sub>3</sub>	d <sub>2</sub>	a		Verfügbarkeit Availability
M 1	0,25	01	40**	5,5		2,5	2,1	0,75	
M 1,1	0,25	01,1	40**	5,5		2,5	2,1	0,85	
M 1,2	0,25	01,2	40**	5,5		2,5	2,1	0,95	
M 1,4	0,3	01,4	40**	7		2,5	2,1	1,10	x
M 1,6	0,35	01,6	40**	8		2,5	2,1	1,25	x
M 1,7*	0,35	01,7	40**	8		2,5	2,1	1,30	
M 1,8	0,35	01,8	40**	8		2,5	2,1	1,45	x
M 2	0,4	02	36	8		2,8	2,1	1,60	x
M 2,2	0,45	02,2	36	9		2,8	2,1	1,75	x
M 2,3*	0,4	02,3	36	9		2,8	2,1	1,90	x
M 2,5	0,45	02,5	40	10		2,8	2,1	2,05	x
M 2,6*	0,45	02,6	40	10		2,8	2,1	2,10	x
M 3	0,5	03	40	10		3,5	2,7	2,50	x
M 3,5	0,6	03,5	45	12		4,0	3,0	2,90	x
M 4	0,7	04	45	12	21	4,5	3,4	3,30	x
M 4,5	0,75	04,5	50	15	24	6,0	4,9	3,70	x
M 5	0,8	05	50	14	22	6,0	4,9	4,20	x
M 6	1	06	56	16	27	6,0	4,9	5,00	x
M 7	1	07	56	16		6,0	4,9	6,00	x
M 8	1,25	08	63	20		6,0	4,9	6,80	x
M 9	1,25	09	63	20		7,0	5,5	7,80	x
M 10	1,5	10	70	22		7,0	5,5	8,50	x
M 11	1,5	11	70	24		8,0	6,2	9,50	x
M 12	1,75	12	75	24		9,0	7,0	10,20	x
M 14	2	14	80	25		11,0	9,0	12,00	x
M 16	2	16	80	28		12,0	9,0	14,00	x
M 18	2,5	18	95	32		14,0	11,0	15,50	x
M 20	2,5	20	95	32		16,0	12,0	17,50	x
M 22	2,5	22	100	32		18,0	14,5	19,50	x
M 24	3	24	110	36		18,0	14,5	21,00	x
M 27	3	27	110	36		20,0	16,0	24,00	x
M 30	3,5	30	125	40		22,0	18,0	26,50	x

\* DIN Profil  
\* Thread profile accord. to DIN

M 33 bis M 68 Fortsetzung Seite G2  
M 33 bis M 68 continued on page G2

x = ab Lager, Zwischenverkauf vorbehalten  
o = nur solange Lagervorrat vorhanden  
x = normally ex stock  
o = available while stocks last



Bis einschl. M 1,4 Toleranz 4H / ISO1  
up to M 1,4 incl. tolerance 4H / ISO1

\*\*< M 2 Baumaße ähnl. DIN 371  
\*\*< M 2 dimensions DIN 371



M



		110 000 Hahnreiter 6H / ISO2			110 020 Hahnreiter 6H / ISO2		
							
		alle gut spanbaren Materialien bis 800 N/mm <sup>2</sup> all free machining materials up to 800 N/mm <sup>2</sup>				alle gut spanbaren Materialien bis 800 N/mm <sup>2</sup> all free machining materials up to 800 N/mm <sup>2</sup>	
		<input type="checkbox"/> P <input type="checkbox"/> K <input type="checkbox"/> N <input type="checkbox"/>				<input type="checkbox"/> P <input type="checkbox"/> K <input type="checkbox"/> N <input type="checkbox"/>	
		Satz à 3 Stück Set of 3 pc.				Satz à 3 Stück mit Führungszapfen Set of 3 pc. with Pilot	
d	P mm	Verfügbarkeit Availability					
M 1	0,25						
M 1,1	0,25						
M 1,2	0,25						
M 1,4	0,3	x					
M 1,6	0,35	x					
M 1,7*	0,35						
M 1,8	0,35	x					
M 2	0,4	x			x		
M 2,2	0,45	x					
M 2,3*	0,4	x					
M 2,5	0,45	x			x		
M 2,6*	0,45	x			x		
M 3	0,5	x			x		
M 3,5	0,6	x			x		
M 4	0,7	x			x		
M 4,5	0,75	x					
M 5	0,8	x			x		
M 6	1	x			x		
M 7	1	x			x		
M 8	1,25	x			x		
M 9	1,25	x					
M 10	1,5	x			x		
M 11	1,5	x					
M 12	1,75	x			x		
M 14	2	x			x		
M 16	2	x			x		
M 18	2,5	x			x		
M 20	2,5	x			x		
M 22	2,5	x			x		
M 24	3	x			x		
M 27	3	x			x		
M 30	3,5	x			x		

\* DIN Profil

\* Thread profile accord. to DIN

M 33 bis M 68 Fortsetzung Seite G2

M 33 bis M 68 continued on page G2

x = ab Lager, Zwischenverkauf vorbehalten

o = nur solange Lagervorrat vorhanden

x = normally ex stock

o = available while stocks last

Bis einschl. M 1,4 Toleranz 4H / ISO1  
up to M 1,4 incl. tolerance 4H / ISO1

M

**Metrisches ISO-Regelgewinde DIN 13**

Baumaße DIN 352, Satz à 3 Stück

**ISO Metric Coarse Threads, DIN 13**

Dimensions DIN 352, Set of 3 pieces

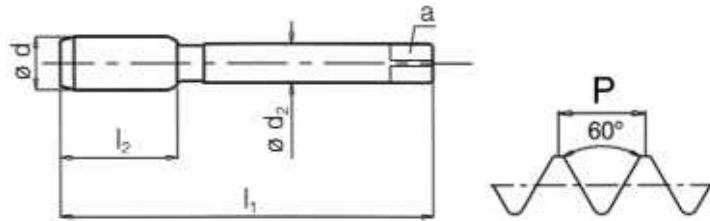

Katalog Nr. Bezeichnung	Catalogue No. Name	110 001 Hahnreiter	110 002 Hahnreiter	110 003 Hahnreiter	110 000 Hahnreiter							
Toleranz	Tolerance	Nr. 1	Nr. 2	6H / ISO2	6H / ISO2							
Anschnittform	Chamfer form	5	3-4	C								
Anschnittlänge, Gang	Chamfer length, threads			2-3								
für Bohrungsart	For holes											
hauptsächliches Einsatzgebiet	Main use	alle gut spanbaren Materialien bis 800 N/mm <sup>2</sup> all free machining materials up to 800 N/mm <sup>2</sup>										
Zerspanungsgruppe, siehe Ausklappseite links	Machinability-group, See folder left page	<input type="checkbox"/> P <input type="checkbox"/> K <input type="checkbox"/> N <input type="checkbox"/>	<input type="checkbox"/> P <input type="checkbox"/> K <input type="checkbox"/> N <input type="checkbox"/>	<input type="checkbox"/> P <input type="checkbox"/> K <input type="checkbox"/> N <input type="checkbox"/>	<input type="checkbox"/> P <input type="checkbox"/> K <input type="checkbox"/> N <input type="checkbox"/>							
Ausführung	Variation	Vorschneider <i>Taper</i>	Mittelschneider <i>Second</i>	Fertigschneider <i>Bottoming</i>	Satz à 3 Stück <i>Set of 3 pc.</i>							
Oberfläche	Surface											
d	P mm	Code	l <sub>1</sub>	l <sub>2</sub>	d <sub>2</sub>	a		Verfügbarkeit Availability				
M 33	3,5	33	125	40	25,0	20,0	29,50	x	x	x		x
M 36	4	36	150	45	28,0	22,0	32,00	x	x	x		x
M 39	4	39	150	45	32,0	24,0	35,00	x	x	x		x
M 42	4,5	42	150	50	32,0	24,0	37,50	x	x	x		x
M 45	4,5	45	160	50	36,0	29,0	40,50	x	x	x		x
M 48	5	48	180	56	36,0	29,0	43,00	x	x	x		x
M 52	5	52	180	56	40,0	32,0	47,00	x	x	x		x
M 56	5,5	56	180	60	40,0	32,0	50,50	x	x	x		x
M 60	5,5	60	200	60	45,0	35,0	54,50	x	x	x		x
M 64	6	64	220	70	50,0	39,0	58,00	x	x	x		x
M 68	6	68	220	70	50,0	39,0	62,00	x	x	x		x

x = ab Lager, Zwischenverkauf vorbehalten  
o = nur solange Lagervorrat vorhanden  
x = normally ex stock  
o = available while stocks last

M

**Metrisches ISO-Regelgewinde DIN 13, Linksgewinde**  
Baumaße DIN 352, Satz à 3 Stück  
**ISO Metric Coarse Threads, DIN 13, Left Hand Thread**  
Dimensions DIN 352, Set of 3 pieces

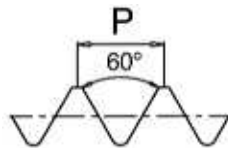
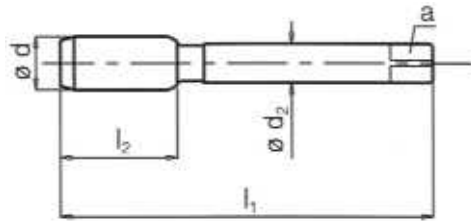

Katalog Nr. Bezeichnung	Catalogue No. Name	110 011 Hahnreiter LH	110 012 Hahnreiter LH	110 013 Hahnreiter LH	110 010 Hahnreiter LH								
Toleranz	Tolerance	Nr. 1	Nr. 2	6H / ISO2	6H / ISO2								
Anschnittform	Chamfer form	5	3-4	C									
Anschnittlänge, Gang	Chamfer length, threads			2-3									
für Bohrungsart	For holes												
hauptsächlich Einsatzgebiet	Main use	alle gut spanbaren Materialien bis 800 N/mm <sup>2</sup> all free machining materials up to 800 N/mm <sup>2</sup>											
Zerspanungsgruppe, siehe Ausklappseite links	Machinability-group, See folder left page												
Ausführung	Variation	Vorschneider Links Taper Left hand	Mittelschneider Links Second Left hand	Fertigschneider Links Bottoming Left hand	Satz à 3 Stück Links Set of 3 pc. Left hand								
Oberfläche	Surface												
d	P mm	Code	l <sub>1</sub>	l <sub>2</sub>	l <sub>3</sub>	d <sub>2</sub>	a		Verfügbarkeit Availability				
M 2	0,4	02	36	8		2,8	2,1	1,60	x	x	x		x
M 2,5	0,45	02,5	40	10		2,8	2,1	2,05	x	x	x		x
M 3	0,5	03	40	10		3,5	2,7	2,50	x	x	x		x
M 4	0,7	04	45	12	21	4,5	3,4	3,30	x	x	x		x
M 5	0,8	05	50	14	22	6,0	4,9	4,20	x	x	x		x
M 6	1	06	56	16	27	6,0	4,9	5,00	x	x	x		x
M 8	1,25	08	63	20		6,0	4,9	6,80	x	x	x		x
M 10	1,5	10	70	22		7,0	5,5	8,50	x	x	x		x
M 12	1,75	12	75	24		9,0	7,0	10,20	x	x	x		x
M 14	2	14	80	25		11,0	9,0	12,00	x	x	x		x
M 16	2	16	80	28		12,0	9,0	14,00	x	x	x		x
M 18	2,5	18	95	32		14,0	11,0	15,50	x	x	x		x
M 20	2,5	20	95	32		16,0	12,0	17,50	x	x	x		x
M 22	2,5	22	100	32		18,0	14,5	19,50	x	x	x		x
M 24	3	24	110	36		18,0	14,5	21,00	x	x	x		x
M 27	3	27	110	36		20,0	16,0	24,00	x	x	x		x
M 30	3,5	30	125	40		22,0	18,0	26,50	x	x	x		x

x = ab Lager, Zwischenverkauf vorbehalten  
o = nur solange Lagervorrat vorhanden  
x = normally ex stock  
o = available while stocks last

M

Metrisches ISO-Regelgewinde DIN 13

Baumaße DIN 352, Satz à 3 Stück

ISO Metric Coarse Threads, DIN 13

Dimensions DIN 352, Set of 3 pieces

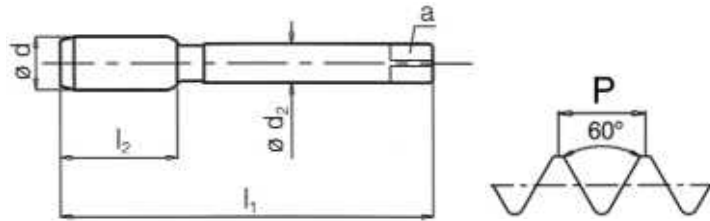



Katalog Nr. Bezeichnung	Catalogue No. Name	110 051 Nirofix	110 041 Nirofix	110 042 Nirofix	110 043 Nirofix					
Toleranz	Tolerance	Nr. 1	Nr. 1	Nr. 2	6H / ISO2					
Anschnittform	Chamfer form	5	5	3-4	C					
Anschnittlänge, Gang	Chamfer length, threads				2-3					
für Bohrungsart	For holes									
hauptsächlich Einsatzgebiet	Main use	für rostfreie Stähle und Stähle > 1000 N/mm <sup>2</sup> for stainless steel and steel > 1000 N/mm <sup>2</sup>								
Zerspanungsgruppe, siehe Ausklappseite links	Machinability-group, See folder left page									
Ausführung	Variation	Vorschneider Taper	Vorschneider mit Führungszapfen Taper with Pilot	Mittelschneider Second	Fertigschneider Bottoming					
Oberfläche	Surface	VAP	VAP	VAP	VAP					
d	P mm	Code	l <sub>1</sub>	l <sub>2</sub>	l <sub>3</sub>	d <sub>2</sub>	a		Verfügbarkeit Availability	
M 2	0,4	02	36	8		2,8	2,1	1,60	x	x
M 2,5	0,45	02,5	40	10		2,8	2,1	2,05	x	x
M 3	0,5	03	40	10		3,5	2,7	2,50	x	x
M 4	0,7	04	45	12	21	4,5	3,4	3,30	x	x
M 5	0,8	05	50	14	22	6,0	4,9	4,20	x	x
M 6	1	06	56	16	27	6,0	4,9	5,00	x	x
M 8	1,25	08	63	20		6,0	4,9	6,80	x	x
M 10	1,5	10	70	22		7,0	5,5	8,50	x	x
M 12	1,75	12	75	24		9,0	7,0	10,20	x	x
M 14	2	14	80	25		11,0	9,0	12,00	x	x
M 16	2	16	80	28		12,0	9,0	14,00	x	x
M 18	2,5	18	95	32		14,0	11,0	15,50	x	x
M 20	2,5	20	95	32		16,0	12,0	17,50	x	x
M 22	2,5	22	100	32		18,0	14,5	19,50	x	x
M 24	3	24	110	36		18,0	14,5	21,00	x	x
M 27	3	27	110	36		20,0	16,0	24,00	x	x
M 30	3,5	30	125	40		22,0	18,0	26,50	x	x

x = ab Lager, Zwischenverkauf vorbehalten  
o = nur solange Lagervorrat vorhanden  
x = normally ex stock  
o = available while stocks last



M



		110 050 Nirofix 6H / ISO2			110 040 Nirofix 6H / ISO2		
							
		für rostfreie Stähle und Stähle > 1000 N/mm <sup>2</sup> for stainless steel and steel > 1000 N/mm <sup>2</sup>			für rostfreie Stähle und Stähle > 1000 N/mm <sup>2</sup> for stainless steel and steel > 1000 N/mm <sup>2</sup>		
		<input type="checkbox"/> P <input checked="" type="checkbox"/> M <input type="checkbox"/> <input type="checkbox"/> <input type="checkbox"/> S			<input type="checkbox"/> P <input checked="" type="checkbox"/> M <input type="checkbox"/> <input type="checkbox"/> <input type="checkbox"/> S		
		Satz à 3 Stück Set of 3 pc.			Satz à 3 Stück mit Führungszapfen Set of 3 pc. with Pilot		
		VAP			VAP		
d	P mm	Verfügbarkeit Availability					
M 2	0,4		x			x	
M 2,5	0,45		x			x	
M 3	0,5		x			x	
M 4	0,7		x			x	
M 5	0,8		x			x	
M 6	1		x			x	
M 8	1,25		x			x	
M 10	1,5		x			x	
M 12	1,75		x			x	
M 14	2		x			x	
M 16	2		x			x	
M 18	2,5		x			x	
M 20	2,5		x			x	
M 22	2,5		x			x	
M 24	3		x			x	
M 27	3		x			x	
M 30	3,5		x			x	

x = ab Lager, Zwischenverkauf vorbehalten  
o = nur solange Lagervorrat vorhanden  
x = normally ex stock  
o = available while stocks last

M

Metrisches ISO-Regelgewinde DIN 13

Baumaße Werksnorm

ISO Metric Coarse Threads, DIN 13

Dimensions manufacturer's standard

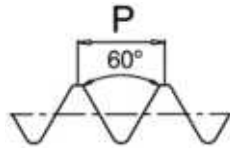
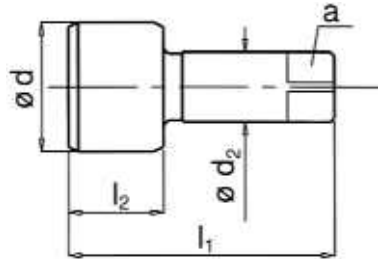

Katalog Nr. Bezeichnung	Catalogue No. Name	110 600 Automat MS	110 601 Automat MS 6G	110 602 Automat MS +0,1	110 605 Automat 15	110 606 Automat 15 6G						
Toleranz	Tolerance	6H / ISO2	6G / ISO3	6H +0,1	6H / ISO2	6G / ISO3						
Anschnittform	Chamfer form	E	E	E	E	E						
Anschnittlänge, Gang	Chamfer length, threads	1,5-2	1,5-2	1,5-2	1,5-2	1,5-2						
für Bohrungsart	For holes											
Sonderwerkstoff	Special material	Messing Brass 3.21			Automatenstahl free cutting steel 1.2							
Zerspanungsgruppe, siehe Ausklappseite links	Machinability-group, See folder left page	<input type="checkbox"/>	<input type="checkbox"/>	<input type="checkbox"/>	<input type="checkbox"/>	<input type="checkbox"/>						
Oberfläche	Surface				VAP	VAP						
Ausführung	Variation		Aufmaß Oversize	Aufmaß Oversize		Aufmaß Oversize						
Typenbeschreibung ab Seite	Type description from page	T2	T2	T2	T2	T2						
d	P	Code	$l_1$	$l_2$	$d_2$	a	Verfügbarkeit Availability					
mm												
M 8	1,25	08	70	17	6,0	4,9	6,80	x	x	x	x	x
M 10	1,5	10	70	22	8,0	6,2	8,50	x	x	x	x	x
M 12	1,75	12	70	22	9,0	7,0	10,20	x	x	x	x	x
M 14	2	14	70	25	10,0	8,0	12,00	x	x	x	x	x
M 16	2	16	70	25	12,0	9,0	14,00	x	x	x	x	x
M 18	2,5	18	70	28	12,0	9,0	15,50	x	x	x	x	x
M 20	2,5	20	70	28	16,0 (15,0)*	12,0	17,50	x	x	x	x	x
< M 8 siehe Seite G9 und G10 'kurze Maschinengewindebohrer für Messing' < M 8 see page G9 and G10 'short machine taps for brass'												
Weitere Abmessungen und Aufmaße ab Lager verfügbar. Bitte anfragen. Other sizes and oversizes ex stock available on request.												

\*solange Lagervorrat liefern wir mit Schaft  $\phi$  15,0  
\*as long as available we will send shank  $\phi$  15,0

x = ab Lager, Zwischenverkauf vorbehalten  
o = nur solange Lagervorrat vorhanden  
x = normally ex stock  
o = available while stocks last

M



		110 619 Automat 20 MS-Z	110 611 Automat 20 6G MS-Z	110 612 Automat 20+0,1 MS-Z	110 616 Automat 20 Sty	110 617 Automat 20 6G Sty	110 618 Automat 20+0,1 Sty	110 607 Automat 20	110 608 Automat 20 6G	110 609 Automat 20+0,1
		6HX E 1,5-2	6GX E 1,5-2	6H +0,1 E 1,5-2	6HX E 1,5-2	6GX E 1,5-2	6H +0,1 E 1,5-2	6HX E 1,5-2	6GX E 1,5-2	6H +0,1 E 1,5-2
		Messing, bleifrei, bleireduziert Brass, leadfree, reduced lead 3.22			Cu-Sonderlegierungen bleifrei, bleireduziert Special copper alloys, leadfree, low-leaded 3.22			Automatenstahl free cutting steel 1.2		
		<input type="checkbox"/>	<input type="checkbox"/>	<input type="checkbox"/>	<input type="checkbox"/>	<input type="checkbox"/>	<input type="checkbox"/>	<input type="checkbox"/>	<input type="checkbox"/>	<input type="checkbox"/>
					Stygian	Stygian	Stygian	VAP	VAP	VAP
			Aufmaß Oversize	Aufmaß Oversize		Aufmaß Oversize	Aufmaß Oversize		Aufmaß Oversize	Aufmaß Oversize
		T2	T2	T2	T2	T2	T2	T2	T2	T2
d	P mm	Verfügbarkeit Availability								
M 8	1,25	x	x	x	x	x	x	x	x	x
M 10	1,5	x	x	x	x	x	x	x	x	x
M 12	1,75	x	x	x	x	x	x	x	x	x
M 14	2	x	x	x	x	x	x	x	x	x
M 16	2	x	x	x	x	x	x	x	x	x
M 18	2,5									
M 20	2,5									
		Weitere Abmessungen und Aufmaße ab Lager verfügbar. Bitte anfragen. Other sizes and oversizes ex stock available on request.								

\* DIN Profil  
\* Thread profile accord. to DIN

x = ab Lager, Zwischenverkauf vorbehalten  
o = nur solange Lagervorrat vorhanden  
x = normally ex stock  
o = available while stocks last

M

Metrisches ISO-Regelgewinde DIN 13

Baumaße Werksnorm

ISO Metric Coarse Threads, DIN 13

Dimensions manufacturer's standard

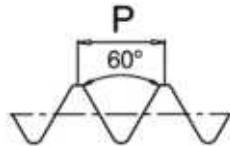
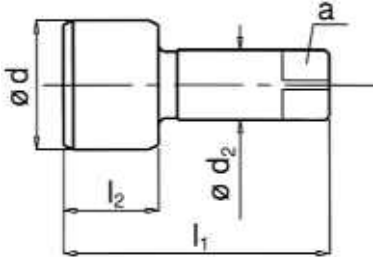

Katalog Nr. Bezeichnung	Catalogue No. Name	110 613 Automat 20 TiN	110 614 Automat 20 6G TiN	110 615 Automat 20+0,1 TiN			
Toleranz	Tolerance	6HX	6GX	6H +0,1			
Anschnittform	Chamfer form	E	E	E			
Anschnittlänge, Gang	Chamfer length, threads	1,5-2	1,5-2	1,5-2			
für Bohrungsart	For holes						
Sonderwerkstoff	Special material	rostfreie Stähle stainless steels 1.9.4. / 1.9.5.					
Zerspanungsgruppe, siehe Ausklappseite links	Machinability-group, See folder left page	<input type="checkbox"/> M <input type="checkbox"/> <input type="checkbox"/> <input type="checkbox"/> <input type="checkbox"/> <input type="checkbox"/>	<input type="checkbox"/> M <input type="checkbox"/> <input type="checkbox"/> <input type="checkbox"/> <input type="checkbox"/> <input type="checkbox"/>	<input type="checkbox"/> M <input type="checkbox"/> <input type="checkbox"/> <input type="checkbox"/> <input type="checkbox"/> <input type="checkbox"/>			
Oberfläche	Surface	TiN	TiN	TiN			
Ausführung	Variation		Aufmaß Oversize	Aufmaß Oversize			
Typenbeschreibung ab Seite	Type description from page	T2	T2	T2			
d	P	Code	$l_1$	$l_2$	$d_2$	a	Verfügbarkeit Availability
	mm						
M 8	1,25	08	70	17	6,0	4,9 6,80	x
M 10	1,5	10	70	22	8,0	6,2 8,50	x
M 12	1,75	12	70	22	9,0	7,0 10,20	x
M 14	2	14	70	25	10,0	8,0 12,00	x
M 16	2	16	70	25	12,0	9,0 14,00	x
M 18	2,5	18	70	28	12,0	9,0 15,50	
M 20	2,5	20	70	28	16,0 (15,0)*	12,0 17,50	
Weitere Abmessungen und Aufmaße ab Lager verfügbar. Bitte anfragen. Other sizes and oversizes ex stock available on request.							

\*solange Lagervorrat liefern wir mit Schaft  $\varnothing 15,0$   
\*as long as available we will send shank  $\varnothing 15,0$

x = ab Lager, Zwischenverkauf vorbehalten  
o = nur solange Lagervorrat vorhanden  
x = normally ex stock  
o = available while stocks last



**M**

**Metrisches ISO-Regelgewinde DIN 13**

Baumaße ≈ ISO 529

**ISO Metric Coarse Threads, DIN 13**

Dimensions ≈ ISO 529

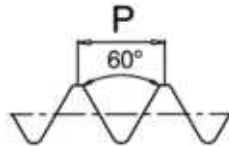
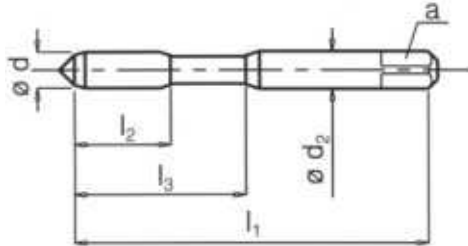

Katalog Nr. Bezeichnung	Catalogue No. Name	110 685 2-Flach	110 686 2-Flach									
Toleranz	Tolerance	6H / ISO2	6G / ISO3									
Anschnittform	Chamfer form	E	E									
Anschnittlänge, Gang	Chamfer length, threads	1,5-2	1,5-2									
für Bohrungsart	For holes											
Sonderwerkstoff	Special material	Messing Brass 3.21										
Zerspanungsgruppe, siehe Ausklappseite links	Machinability-group, See folder left page	<input type="checkbox"/> <input type="checkbox"/> <input checked="" type="checkbox"/> <input type="checkbox"/> <input type="checkbox"/> <input type="checkbox"/> <input type="checkbox"/> <input type="checkbox"/>										
Oberfläche	Surface											
Ausführung	Variation	2 flache Nuten 2 flat flutes										
Typenbeschreibung ab Seite	Type description from page	T2	T2									
d	P mm	Code	l <sub>1</sub>	l <sub>2</sub>	l <sub>3</sub>	d <sub>2</sub>	a		Verfügbarkeit Availability			
M 2	0,4	02	45	8	10	2,8	2,1	1,60	x	x		
M 2,5	0,45	02,5	50	9	14	2,8	2,1	2,05	x	x		
M 2,6	0,45	02,6	50	10	14	2,8	2,1	2,10	x	x		
M 3	0,5	03	48	10	17	3,0	2,4	2,50	x	x		
M 3,5	0,6	03,5	50	13	20	3,5	2,7	2,90	x	x		
M 4	0,7	04	53	13	21	4,0	3,0	3,30	x	x		
M 5	0,8	05	58	16	25	5,0	3,8	4,20	x	x		
M 6	1	06	66	20	31	6,0	4,9	5,00	x	x		
Ausführung mit 3 Nuten siehe Seite G10 und G17 Type with 3 flutes see page G10 and G17												
bis M 2,6 Baumaße = DIN 371 up to M 2,6 dimensions = DIN 371												

x = ab Lager, Zwischenverkauf vorbehalten  
o = nur solange Lagervorrat vorhanden  
x = normally ex stock  
o = available while stocks last

M

Metrisches ISO-Regelgewinde DIN 13

Baumaße DIN 352, kurze Ausführung

ISO Metric Coarse Threads, DIN 13

Dimensions DIN 352, Short taps

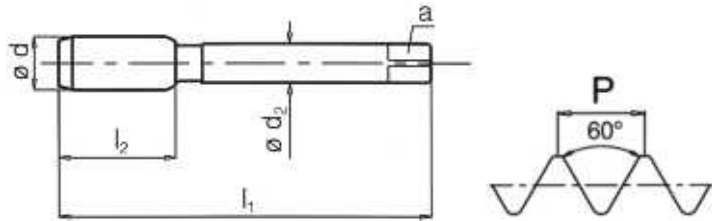

Katalog Nr. Bezeichnung	Catalogue No. Name	110 100 Hahnreiter	110 118 Spiralo 15	110 126 Spiralo 35	110 180 Hahnreiter MS	110 184 Hahnreiter MS 6G				
Toleranz	Tolerance	6H / ISO2	6H / ISO2	6H / ISO2	6H / ISO2	6G / ISO3				
Anschnittform	Chamfer form	C	C	C	E	E				
Anschnittlänge, Gang	Chamfer length, threads	2-3	2-3	2-3	1,5-2	1,5-2				
für Bohrungsart	For holes									
Sonderwerkstoff	Special material				Messing Brass 3.21	Messing Brass 3.21				
Zerspanungsgruppe, siehe Ausklappseite links	Machinability-group, See folder left page	<input type="checkbox"/> P <input type="checkbox"/> <input type="checkbox"/> <input type="checkbox"/> <input type="checkbox"/>	<input type="checkbox"/> P <input type="checkbox"/> <input type="checkbox"/> <input type="checkbox"/> <input type="checkbox"/>	<input type="checkbox"/> P <input type="checkbox"/> <input type="checkbox"/> <input type="checkbox"/> <input type="checkbox"/>	<input type="checkbox"/> <input type="checkbox"/> <input type="checkbox"/> <input type="checkbox"/> <input checked="" type="checkbox"/> N <input type="checkbox"/>	<input type="checkbox"/> <input type="checkbox"/> <input type="checkbox"/> <input type="checkbox"/> <input checked="" type="checkbox"/> N <input type="checkbox"/>				
Oberfläche	Surface									
Ausführung	Variation					Aufmaß Oversize				
Typenbeschreibung ab Seite	Type description from page	T2	T2	T2	T2	T2				
d	P	Code	l <sub>1</sub>	l <sub>2</sub>	l <sub>2</sub>	l <sub>3</sub>	d <sub>2</sub>	a	Verfügbarkeit Availability	
	mm				SSP**					
M 3	0,5	03	40	10		18	3,5	2,7	2,50	x
M 3,5	0,6	03,5	45	12		20	4,0	3,0	2,90	x
M 4	0,7	04	45	12	7	21	4,5	3,4	3,30	x
M 5	0,8	05	50	14	9	22	6,0	4,9	4,20	x
M 6	1	06	56	16	10	27	6,0	4,9	5,00	x
M 7	1	07	56	16			6,0	4,9	6,00	
M 8	1,25	08	63	20	13		6,0	4,9	6,80	x
M 10	1,5	10	70	22	14		7,0	5,5	8,50	x
M 12	1,75	12	75	24	16		9,0	7,0	10,20	x
M 14	2	14	80	25	20		11,0	9,0	12,00	
M 16	2	16	80	28	20		12,0	9,0	14,00	
M 18	2,5	18	95	32			14,0	11,0	15,50	
M 20	2,5	20	95	32			16,0	12,0	17,50	
M 22	2,5	22	100	32			18,0	14,5	19,50	
M 24	3	24	110	36			18,0	14,5	21,00	

x = ab Lager, Zwischenverkauf vorbehalten  
o = nur solange Lagervorrat vorhanden  
x = normally ex stock  
o = available while stocks last

\*\* SSP = Steilspirale  
\*\* SSP = quick spiral

**M**

**Metrisches ISO-Regelgewinde DIN 13**  
Baumaße DIN 371, verstärkter Schaft  
**ISO Metric Coarse Threads, DIN 13**  
Dimensions DIN 371, Reinforced shank

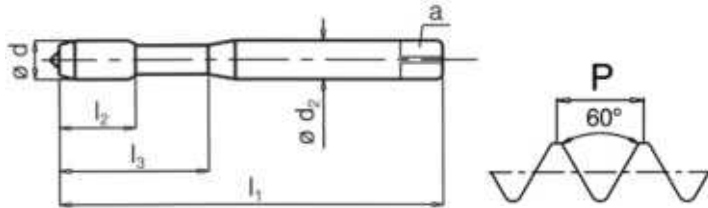

Katalog Nr. Bezeichnung	Catalogue No. Name	110 200 Hahnreiter	110 201 Hahnreiter 6G	110 204 Hahnreiter LH	110 205 Dulofix	110 210 Dulofix TiN					
Toleranz	Tolerance	6H / ISO2	6G / ISO3	6H / ISO2	6H / ISO2	6H / ISO2					
Anschnittform	Chamfer form	C	C	C	B	B					
Anschnittlänge, Gang	Chamfer length, threads	2-3	2-3	2-3	4-5	4-5					
für Bohrungsart	For holes										
Sonderwerkstoff	Special material										
Zerspanungsgruppe, siehe Ausklappseite links	Machinability-group, See folder left page	<input type="checkbox"/> P <input type="checkbox"/> <input type="checkbox"/> <input type="checkbox"/> <input type="checkbox"/>	<input type="checkbox"/> P <input type="checkbox"/> <input type="checkbox"/> <input type="checkbox"/> <input type="checkbox"/>	<input type="checkbox"/> P <input type="checkbox"/> <input type="checkbox"/> <input type="checkbox"/> <input type="checkbox"/>	<input type="checkbox"/> P <input type="checkbox"/> <input type="checkbox"/> <input type="checkbox"/> <input checked="" type="checkbox"/> N <input type="checkbox"/>	<input type="checkbox"/> P <input type="checkbox"/> <input type="checkbox"/> <input type="checkbox"/> <input checked="" type="checkbox"/> N <input type="checkbox"/>					
Oberfläche	Surface					TiN					
Ausführung	Variation		Aufmaß Oversize	Links Left hand							
Typenbeschreibung ab Seite	Type description from page	T2	T2	T2	T2	T2					
d	P mm	Code	l <sub>1</sub>	l <sub>2</sub>	l <sub>3</sub>	d <sub>2</sub>	a		Verfügbarkeit Availability		
M 1	0,25	01	40	5,5		2,5	2,1	0,75			
M 1,1	0,25	01,1	40	5,5		2,5	2,1	0,85			
M 1,2	0,25	01,2	40	5,5		2,5	2,1	0,95			
M 1,4	0,3	01,4	40	7		2,5	2,1	1,10	x		
M 1,6	0,35	01,6	40	8		2,5	2,1	1,25	x		
M 1,7*	0,35	01,7	40	8		2,5	2,1	1,30	x		
M 1,8	0,35	01,8	40	8		2,5	2,1	1,45	x		
M 2	0,4	02	45	6	10	2,8	2,1	1,60	x		x
M 2,2	0,45	02,2	45	6	10	2,8	2,1	1,75	x		
M 2,3*	0,4	02,3	50	9	14	2,8	2,1	1,90	x		
M 2,5	0,45	02,5	50	9	14	2,8	2,1	2,05	x		x
M 2,6*	0,45	02,6	50	9	14	2,8	2,1	2,10	x		
M 3	0,5	03	56	10	18	3,5	2,7	2,50	x	x	x
M 3,5	0,6	03,5	56	11	20	4,0	3,0	2,90	x		x
M 4	0,7	04	63	12	23	4,5	3,4	3,30	x	x	x
M 4,5	0,75	04,5	70	14	25	6,0	4,9	3,70			x
M 5	0,8	05	70	14	25	6,0	4,9	4,20	x	x	x
M 6	1	06	80	17	30	6,0	4,9	5,00	x	x	x
M 7	1	07	80	17	30	7,0	5,5	6,00	x		x
M 8	1,25	08	90	18	35	8,0	6,2	6,80	x	x	x
M 9	1,25	09	90	18	35	9,0	7,0	7,80	x		x
M 10	1,5	10	100	20	39	10,0	8,0	8,50	x	x	x
M 12	1,75	12	110	22	44	12,0	9,0	10,20	x		x

\* DIN Profil  
\* Thread profile accord. to DIN

Bis einschl. M 1,4 Toleranz 4H / ISO1  
up to M 1,4 incl. tolerance 4H / ISO1

x = ab Lager, Zwischenverkauf vorbehalten  
o = nur solange Lagervorrat vorhanden  
x = normally ex stock  
o = available while stocks last

M

**Metrisches ISO-Regelgewinde DIN 13**  
Baumaße DIN 371, verstärkter Schaft  
**ISO Metric Coarse Threads, DIN 13**  
Dimensions DIN 371, Reinforced shank

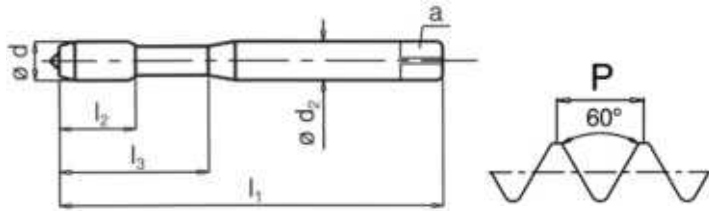

Katalog Nr. Bezeichnung	Catalogue No. Name	110 295 Dulofix TiCN	110 202 Dulofix VAP	110 206 Dulofix 4H	110 207 Dulofix 6G	110 214 Dulofix 6G TiN	
Toleranz	Tolerance	6H / ISO2	6H / ISO2	4H / ISO 1	6G / ISO3	6G / ISO3	
Anschnittform	Chamfer form	B	B	B	B	B	
Anschnittlänge, Gang	Chamfer length, threads	4-5	4-5	4-5	4-5	4-5	
für Bohrungsart	For holes						
Sonderwerkstoff	Special material						
Zerspanungsgruppe, siehe Ausklappseite links	Machinability-group, See folder left page	<input type="checkbox"/> P <input type="checkbox"/> <input type="checkbox"/> <input type="checkbox"/> <input type="checkbox"/> <input type="checkbox"/> <input type="checkbox"/> <input type="checkbox"/> <input type="checkbox"/> <input type="checkbox"/> <input type="checkbox"/>	<input type="checkbox"/> P <input type="checkbox"/> <input type="checkbox"/> <input type="checkbox"/> <input type="checkbox"/> <input type="checkbox"/> <input type="checkbox"/> <input type="checkbox"/> <input type="checkbox"/> <input type="checkbox"/>	<input type="checkbox"/> P <input type="checkbox"/> <input type="checkbox"/> <input type="checkbox"/> <input type="checkbox"/> <input type="checkbox"/> <input type="checkbox"/> <input type="checkbox"/> <input type="checkbox"/> <input type="checkbox"/>	<input type="checkbox"/> P <input type="checkbox"/> <input type="checkbox"/> <input type="checkbox"/> <input type="checkbox"/> <input type="checkbox"/> <input type="checkbox"/> <input type="checkbox"/> <input type="checkbox"/> <input type="checkbox"/>	<input type="checkbox"/> P <input type="checkbox"/> <input type="checkbox"/> <input type="checkbox"/> <input type="checkbox"/> <input type="checkbox"/> <input type="checkbox"/> <input type="checkbox"/> <input type="checkbox"/> <input type="checkbox"/>	
Oberfläche	Surface	TiCN	VAP			TiN	
Ausführung	Variation			enge Toleranz Tight tolerance	Aufmaß Oversize	Aufmaß Oversize	
Typenbeschreibung ab Seite	Type description from page	T2	T2	T2	T2	T2	
d	P	Verfügbarkeit					
mm	Code	Availability					
M 1	0,25 01						
M 1,1	0,25 01,1						
M 1,2	0,25 01,2						
M 1,4	0,3 01,4						
M 1,6	0,35 01,6						
M 1,7*	0,35 01,7						
M 1,8	0,35 01,8						
M 2	0,4 02						
M 2,2	0,45 02,2						
M 2,3*	0,4 02,3						
M 2,5	0,45 02,5				x	x	
M 2,6*	0,45 02,6						
M 3	0,5 03	x	x	x	x	x	
M 3,5	0,6 03,5				x	x	
M 4	0,7 04	x	x	x	x	x	
M 4,5	0,75 04,5						
M 5	0,8 05	x	x	x	x	x	
M 6	1 06	x	x	x	x	x	
M 7	1 07						
M 8	1,25 08	x	x	x	x	x	
M 9	1,25 09						
M 10	1,5 10	x	x	x	x	x	
M 12	1,75 12						

\* DIN Profil  
\* Thread profile accord. to DIN

x = ab Lager, Zwischenverkauf vorbehalten  
o = nur solange Lagervorrat vorhanden  
x = normally ex stock  
o = available while stocks last



M



	110 208 Dulofix 7G	110 220 Dulofix +0,1	110 212 Dulofix LH	110 209 Dulofix AZ	110 215 Standfest 0	110 216 Standfest 2	110 219 Standfest 2 6G	110 218 Spiralo 15	110 224 Spiralo 15 TiN
	7G B 4-5	6H +0,1 B 4-5	6H / ISO2 B 4-5	6H / ISO2 B 4-5	6H / ISO2 B 4-5	6H / ISO2 B 4-5	6G / ISO3 B 4-5	6H / ISO2 C 2-3	6H / ISO2 C 2-3
				weiches Material soft material 1.1.0					
	<input type="checkbox"/> P <input type="checkbox"/> <input type="checkbox"/> <input type="checkbox"/> <input checked="" type="checkbox"/> N <input type="checkbox"/>	<input type="checkbox"/> P <input type="checkbox"/> <input type="checkbox"/> <input type="checkbox"/> <input checked="" type="checkbox"/> N <input type="checkbox"/>	<input type="checkbox"/> P <input type="checkbox"/> <input type="checkbox"/> <input type="checkbox"/> <input checked="" type="checkbox"/> N <input type="checkbox"/>	<input type="checkbox"/> P <input type="checkbox"/> <input type="checkbox"/> <input type="checkbox"/> <input checked="" type="checkbox"/> N <input type="checkbox"/>	<input type="checkbox"/> P <input type="checkbox"/> <input type="checkbox"/> <input type="checkbox"/> <input type="checkbox"/>	<input type="checkbox"/> P <input type="checkbox"/> <input type="checkbox"/> <input type="checkbox"/> <input type="checkbox"/>	<input type="checkbox"/> P <input type="checkbox"/> <input type="checkbox"/> <input type="checkbox"/> <input type="checkbox"/>	<input type="checkbox"/> P <input type="checkbox"/> <input type="checkbox"/> <input checked="" type="checkbox"/> N <input type="checkbox"/>	<input type="checkbox"/> P <input type="checkbox"/> <input type="checkbox"/> <input type="checkbox"/> <input checked="" type="checkbox"/> N <input type="checkbox"/>
	Aufmaß Oversize	Aufmaß Oversize	Links Left hand	ausgesetzte Zähne Interrupted teeth	ohne Nuten Fluteless	2 Schmiernuten 2 oilgrooves	Aufmaß Oversize		TiN
	T2	T2	T2	T2	T2	T2	T2	T2	T2
d	P mm	Verfügbarkeit Availability							
M 1	0,25				X				
M 1,1	0,25				X				
M 1,2	0,25				X				
M 1,4	0,3				X				
M 1,6	0,35				X				
M 1,7	0,35				X				
M 1,8	0,35				X				
M 2	0,4				X	X	X	X	
M 2,2	0,45				X	X		X	
M 2,3*	0,4				X	X		X	
M 2,5	0,45				X	X	X	X	
M 2,6*	0,45				X	X		X	
M 3	0,5	X	X	X	O	X	X	X	X
M 3,5	0,6			X	O	X		X	O
M 4	0,7	X	X	X	O	X	X	X	X
M 4,5	0,75							X	
M 5	0,8	X	X	X	O	O	O	X	X
M 6	1	X	X	X	O	O	O	X	X
M 7	1							X	
M 8	1,25	X	X	X	O			X	X
M 9	1,25							X	
M 10	1,5	X	X	X				X	X
M 12	1,75								

\* DIN Profil  
\* Thread profile accord. to DIN

Bis einschl. M 1,4 Toleranz 4H / ISO1  
up to M 1,4 incl. tolerance 4H / ISO1

x = ab Lager, Zwischenverkauf vorbehalten  
o = nur solange Lagervorrat vorhanden  
x = normally ex stock  
o = available while stocks last

M

**Metrisches ISO-Regelgewinde DIN 13**  
Baumaße DIN 371, verstärkter Schaft  
**ISO Metric Coarse Threads, DIN 13**  
Dimensions DIN 371, Reinforced shank

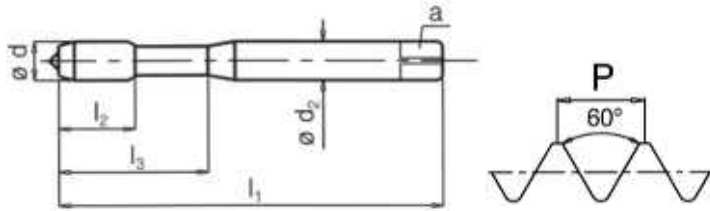

Katalog Nr. Bezeichnung	Catalogue No. Name	110 225 Spiralo 15 TiCN	110 221 Spiralo 15 6G	110 223 Spiralo 15 AZ	110 226 Spiralo 35	110 235 Spiralo 35 TiN										
Toleranz	Tolerance	6H / ISO2	6G / ISO3	6H / ISO2	6H / ISO2	6H / ISO2										
Anschnittform	Chamfer form	C	C	C	C	C										
Anschnittlänge, Gang	Chamfer length, threads	2-3	2-3	2-3	2-3	2-3										
für Bohrungsart	For holes															
Sonderwerkstoff	Special material	Alu-Guss Alu-castings 4.16		weiches Material soft material 1.1.0/3.20/4.14												
Zerspanungsgruppe, siehe Ausklappseite links	Machinability-group, See folder left page	<input type="checkbox"/> P <input type="checkbox"/> N <input type="checkbox"/>	<input type="checkbox"/> P <input type="checkbox"/> N <input type="checkbox"/>	<input type="checkbox"/> P <input type="checkbox"/> N <input type="checkbox"/>	<input type="checkbox"/> P <input type="checkbox"/> N <input type="checkbox"/>	<input type="checkbox"/> P <input type="checkbox"/> N <input type="checkbox"/>										
Oberfläche	Surface	TiCN				TiN										
Ausführung	Variation		Aufmaß Oversize	ausgesetzte Zähne Interrupted teeth												
Typenbeschreibung ab Seite	Type description from page	T2	T2	T2	T2	T2										
d	P	Code	l <sub>1</sub>	l <sub>2</sub>	l <sub>2</sub> SSP**	l <sub>3</sub>	d <sub>2</sub>	a		Verfügbarkeit Availability						
M 2	0,4	02	45	6		10	2,8	2,1	1,60						x	x
M 2,2	0,45	02,2	45	6		10	2,8	2,1	1,75						x	
M 2,3*	0,4	02,3	50	9		14	2,8	2,1	1,90						x	
M 2,5	0,45	02,5	50	9		14	2,8	2,1	2,05						x	x
M 2,6*	0,45	02,6	50	9		14	2,8	2,1	2,10						x	
M 3	0,5	03	56	10	6	18	3,5	2,7	2,50	x	x	x			x	x
M 3,5	0,6	03,5	56	11	7	20	4,0	3,0	2,90						x	x
M 4	0,7	04	63	12	7	23	4,5	3,4	3,30	x	x	x			x	x
M 5	0,8	05	70	14	9	25	6,0	4,9	4,20	x	x	x			x	x
M 6	1	06	80	17	10	30	6,0	4,9	5,00	x	x	x			x	x
M 7	1	07	80	17	10	30	7,0	5,5	6,00						x	
M 8	1,25	08	90	18	12	35	8,0	6,2	6,80	x	x	x			x	x
M 10	1,5	10	100	20	14	39	10,0	8,0	8,50	x	x	x			x	x
M 12	1,75	12	110	22	16	44	12,0	9,0	10,20						x	

\* DIN Profil  
\* Thread profile accord. to DIN

x = ab Lager, Zwischenverkauf vorbehalten  
o = nur solange Lagervorrat vorhanden  
x = normally ex stock  
o = available while stocks last

M



	110 296 Spiralo 35 TiCN	110 236 Spiralo 35 VAP	110 228 Spiralo 35 4H	110 229 Spiralo 35 6G	110 222 Spiralo 35 6G TiN	110 230 Spiralo 35 7G	110 233 Spiralo 35 +0,1	110 231 Spiralo 35 E	110 232 Spiralo 35 TS
	6H / ISO2 C 2-3	6H / ISO2 C 2-3	4H / ISO1 C 2-3	6G / ISO3 C 2-3	6G / ISO3 C 2-3	7G C 2-3	6H +0,1 C 2-2	6H / ISO2 E 1,5-2	6H / ISO2 C 2-3
				weiches Material soft material 1.1.0					
	<input type="checkbox"/> P <input type="checkbox"/> <input type="checkbox"/> <input type="checkbox"/> <input checked="" type="checkbox"/> N <input type="checkbox"/>	<input type="checkbox"/> P <input type="checkbox"/> <input type="checkbox"/> <input type="checkbox"/> <input type="checkbox"/>	<input type="checkbox"/> P <input type="checkbox"/> <input type="checkbox"/> <input type="checkbox"/> <input checked="" type="checkbox"/> N <input type="checkbox"/>	<input type="checkbox"/> P <input type="checkbox"/> <input type="checkbox"/> <input type="checkbox"/> <input checked="" type="checkbox"/> N <input type="checkbox"/>	<input type="checkbox"/> P <input type="checkbox"/> <input type="checkbox"/> <input type="checkbox"/> <input checked="" type="checkbox"/> N <input type="checkbox"/>	<input type="checkbox"/> P <input type="checkbox"/> <input type="checkbox"/> <input type="checkbox"/> <input checked="" type="checkbox"/> N <input type="checkbox"/>	<input type="checkbox"/> P <input type="checkbox"/> <input type="checkbox"/> <input type="checkbox"/> <input checked="" type="checkbox"/> N <input type="checkbox"/>	<input type="checkbox"/> P <input type="checkbox"/> <input type="checkbox"/> <input type="checkbox"/> <input checked="" type="checkbox"/> N <input type="checkbox"/>	<input type="checkbox"/> P <input type="checkbox"/> <input type="checkbox"/> <input type="checkbox"/> <input checked="" type="checkbox"/> N <input type="checkbox"/>
	TiCN	VAP			TiN				
			enge Toleranz Tight tolerance	Aufmaß Oversize	Aufmaß Oversize	Aufmaß Oversize	Aufmaß Oversize	Anschn.extra kurz Chamf.extra short	tiefe Sacklöcher Deep blind holes
	T2	T2	T2	T2	T2	T2	T2	T2	T2
d	P mm	Verfügbarkeit Availability							
M 2	0,4			x	x		x		
M 2,2	0,45								
M 2,3*	0,4								
M 2,5	0,45			x	x	x	x		
M 2,6*	0,45								
M 3	0,5	x	x	x	x	x	x	x	x
M 3,5	0,6			o					o
M 4	0,7	x	x	x	x	x	x	x	x
M 5	0,8	x	x	x	x	x	x	x	x
M 6	1	x	x	x	x	x	x	x	x
M 7	1								
M 8	1,25	x	x	x	x	x	x	x	x
M 10	1,5	x	x	x	x	x	x	x	x

\* DIN Profil  
\* Thread profile accord. to DIN

x = ab Lager, Zwischenverkauf vorbehalten  
o = nur solange Lagervorrat vorhanden  
x = normally ex stock  
o = available while stocks last

M

**Metrisches ISO-Regelgewinde DIN 13**  
Baumaße DIN 371, verstärkter Schaft  
**ISO Metric Coarse Threads, DIN 13**  
Dimensions DIN 371, Reinforced shank

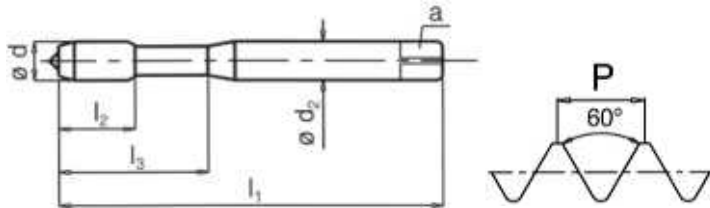

Katalog Nr. Bezeichnung	Catalogue No. Name	110 234 Spiralo 35 AZ	110 238 Spiralo 35 LH	110 253 Spiralo 48 TS TiN	110 254 Spiralo 48 TS TiN	110 227 Spiralo 45 ZB						
Toleranz	Tolerance	6H / ISO2	6H / ISO2	6H / ISO2	6G / ISO3	6H / ISO2						
Anschnittform	Chamfer form	C	C	C	C	C						
Anschnittlänge, Gang	Chamfer length, threads	2-3	2-3	2-3	2-3	2-3						
für Bohrungsart	For holes											
Sonderwerkstoff	Special material	weiches Material soft material 1.1.0 / 3.20										
Zerspanungsgruppe, siehe Ausklappseite links	Machinability-group, See folder left page	<input type="checkbox"/> P <input type="checkbox"/> N <input type="checkbox"/>	<input type="checkbox"/> P <input type="checkbox"/> N <input type="checkbox"/>	<input type="checkbox"/> P <input type="checkbox"/> N <input type="checkbox"/>	<input type="checkbox"/> P <input type="checkbox"/> N <input type="checkbox"/>	<input type="checkbox"/> P <input type="checkbox"/> N <input type="checkbox"/>						
Oberfläche	Surface			TiN	TiN	TiN/VAP						
Ausführung	Variation	ausgesetzte Zähne Interrupted teeth	Links Left hand	tiefe Sacklöcher 3xD deep blind holes 3xD								
Typenbeschreibung ab Seite	Type description from page	T2	T2	T2	T2	T2						
d	P	Code	l <sub>1</sub>	l <sub>2</sub>	l <sub>2</sub> ssp**	l <sub>3</sub>	d <sub>2</sub>	a	Verfügbarkeit Availability			
	mm											
M 2	0,4	02	45	6		10	2,8	2,1	1,60			
M 2,2	0,45	02,2	45	6		10	2,8	2,1	1,75			
M 2,3*	0,4	02,3	50	9		14	2,8	2,1	1,90			
M 2,5	0,45	02,5	50	9		14	2,8	2,1	2,05			
M 2,6*	0,45	02,6	50	9		14	2,8	2,1	2,10			
M 3	0,5	03	56	10	6	18	3,5	2,7	2,50		x	x
M 3,5	0,6	03,5	56	11	7	20	4,0	3,0	2,90			
M 4	0,7	04	63	12	7	23	4,5	3,4	3,30		x	x
M 5	0,8	05	70	14	9	25	6,0	4,9	4,20		x	x
M 6	1	06	80	17	10	30	6,0	4,9	5,00	x	x	x
M 8	1,25	08	90	18	12	35	8,0	6,2	6,80	x	x	x
M 10	1,5	10	100	20	14	39	10,0	8,0	8,50	x	x	x

\* DIN Profil  
\* Thread profile accord. to DIN

\*\*SSP = Steilspirale  
\*\*SSP = quick spiral

x = ab Lager, Zwischenverkauf vorbehalten  
o = nur solange Lagervorrat vorhanden  
x = normally ex stock  
o = available while stocks last





M

**Metrisches ISO-Regelgewinde DIN 13**  
Baumaße DIN 371, verstärkter Schaft  
**ISO Metric Coarse Threads, DIN 13**  
Dimensions DIN 371, Reinforced shank

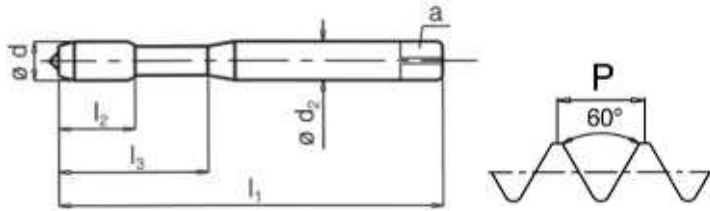

Katalog Nr. Bezeichnung	Catalogue No. Name	110 260 Nirofix	110 261 Nirofix AZ	110 266 Nirofix TiN	110 269 Nirofix-Z STY/WC															
Toleranz	Tolerance	6H / ISO2	6H / ISO2	6H / ISO2	6HX															
Anschnittform	Chamfer form	B	B	B	B															
Anschnittlänge, Gang	Chamfer length, threads	4-5	4-5	4-5	4-5															
für Bohrungsart	For holes																			
Sonderwerkstoff	Special material	rostfreie Stähle Stainless steels 1.9.4		rostfreie Stähle Stainless steels 1.9.5 / 3.20																
Zerspanungsgruppe, siehe Ausklappseite links	Machinability-group, See folder left page	<input type="checkbox"/> M <input type="checkbox"/>	<input type="checkbox"/> M <input type="checkbox"/>	<input type="checkbox"/> P <input type="checkbox"/> M <input type="checkbox"/> K <input type="checkbox"/>	<input type="checkbox"/> P <input type="checkbox"/> M <input type="checkbox"/> N <input type="checkbox"/>															
Oberfläche	Surface	VAP	VAP	TiN	STY/WC															
Ausführung	Variation		ausgesetzte Zähne Interrupted teeth																	
Typenbeschreibung ab Seite	Type description from page	T2	T2	T2	T2															
d	P	Code	l <sub>1</sub>	l <sub>2</sub>	l <sub>2</sub>	l <sub>3</sub>	d <sub>2</sub>	a	Verfügbarkeit Availability											
	mm				SSP**															
M 2	0,4	02	45	6		10	2,8	2,1	1,60	x										x
M 2,2	0,45	02,2	45	6		10	2,8	2,1	1,75	x										
M 2,3***	0,4	02,3	50	9		14	2,8	2,1	1,90	o										
M 2,5	0,45	02,5	50	9		14	2,8	2,1	2,05	x										x
M 2,6***	0,45	02,6	50	9		14	2,8	2,1	2,10											
M 3	0,5	03	56	10	6	18	3,5	2,7	2,50	x	x		x							x
M 3,5	0,6	03,5	56	11	7	20	4,0	3,0	2,90	x	o									
M 4	0,7	04	63	12	7	23	4,5	3,4	3,30	x	x		x							x
M 5	0,8	05	70	14	9	25	6,0	4,9	4,20	x	x		x							x
M 6	1	06	80	17	10	30	6,0	4,9	5,00	x	x		x							x
M 8	1,25	08	90	18	12	35	8,0	6,2	6,80	x	x		x							x
M 10	1,5	10	100	20	14	39	10,0	8,0	8,50	x	x		x							x

\*\*\* DIN Profil

\*\*\* Thread profile accord. to DIN

\*\*SSP = Steilschneide

\*\*SSP = quick spiral

x = ab Lager, Zwischenverkauf vorbehalten

o = nur solange Lagerbestand vorhanden

x = normally ex stock

o = available while stocks last

M

HSS-EP

HSS-EP



	110 263 Nirofix 35	110 265 Nirofix 35 TS	110 267 Nirofix 35 TiN	110 268 Nirofix 48 STY/WC	110 270 Dulofix VS	110 271 Spiralo 35 VS	110 256 Multifix	110 257 Multifix 35	110 297 Spiralo 15 HF TiCN
	6H / ISO2 C 2-3	6H / ISO2 C 2-3	6H / ISO2 C 2-3	6HX C 2-3	6H / ISO2 B 4-5	6H / ISO2 C 2-3	6H / ISO2 B 4-5	6H / ISO2 C 2-3	6HX C 2-3
	rostfreie Stähle Stainless steels 1.9.4			rostfreie Stähle Stainless steels 1.9.5/3.20	Vergütungsstähle Heat-treatable steels		Werkzeugstähle Toolsteels 1.7 / 3.23		** 1.7 / 1.8
	VAP	VAP	TiN	STY/WC			Stygian	Stygian	TiCN
		tiefe Sacklöcher Deep blind holes							kurze Späne short chips
	T2	T2	T2	T2	T2	T2	T2	T2	T2
d	P mm	Verfügbarkeit Availability							
M 2	0,4	x			x	x	x	x	
M 2,2	0,45	x							
M 2,3***	0,4								
M 2,5	0,45	x			x	x	x	x	
M 2,6***	0,45	o							
M 3	0,5	x	x	x	x	x	x	x	x
M 3,5	0,6	x							
M 4	0,7	x	x	x	x	x	x	x	x
M 5	0,8	x	x	x	x	x	x	x	x
M 6	1	x	x	x	x	x	x	x	x
M 8	1,25	x	x	x	x	x	x	x	x
M 10	1,5	x	x	x	x	x	x	x	x

\*\*Geometrie bildet bei geeigneten Materialien kurze Späne.  
Für das sichere Ausspülen ist eine Hochdruck-Kühlung unerlässlich.  
\*\*Geometry creates short chips machining suitable materials.  
High-pressure cooling is essential for safe chip evacuation.

\*\*\* DIN Profil  
\*\*\* Thread profile accord. to DIN

x = ab Lager, Zwischenverkauf vorbehalten  
o = nur solange Lagervorrat vorhanden  
x = normally ex stock  
o = available while stocks last

M

**Metrisches ISO-Regelgewinde DIN 13**  
Baumaße DIN 371, verstärkter Schaft  
**ISO Metric Coarse Threads, DIN 13**  
Dimensions DIN 371, Reinforced shank

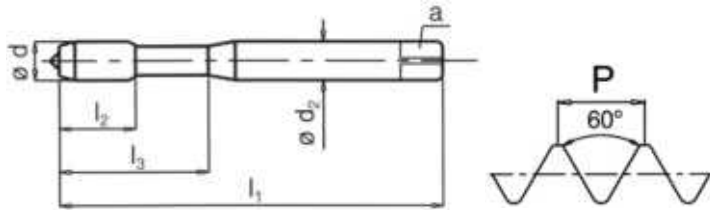

HSS-EP HSS-EP HSS-EP HSS-EP



Katalog Nr. Bezeichnung	Catalogue No. Name	110 273 Dulofix HF	110 292 Dulofix HF TiCN	110 274 Spiralo 35 HF	110 293 Spir. 35 HF TiCN					
Toleranz	Tolerance	6H / ISO2	6H / ISO2	6H / ISO2	6H / ISO2					
Anschnittform	Chamfer form	B	B	C	C					
Anschnittlänge, Gang	Chamfer length, threads	4-5	4-5	2-3	2-3					
für Bohrungsart	For holes									
Sonderwerkstoff	Special material	hochfeste Stähle Hard materials 1.4.3 / 1.5.3 / 1.6.3 / 1.8								
Zerspanungsgruppe, siehe Ausklappseite links	Machinability-group, See folder left page	<input type="checkbox"/> P <input type="checkbox"/> <input type="checkbox"/> <input type="checkbox"/> <input type="checkbox"/> <input type="checkbox"/>	<input type="checkbox"/> P <input type="checkbox"/> <input type="checkbox"/> <input type="checkbox"/> <input type="checkbox"/> <input type="checkbox"/>	<input type="checkbox"/> P <input type="checkbox"/> <input type="checkbox"/> <input type="checkbox"/> <input type="checkbox"/> <input type="checkbox"/>	<input type="checkbox"/> P <input type="checkbox"/> <input type="checkbox"/> <input type="checkbox"/> <input type="checkbox"/> <input type="checkbox"/>					
Oberfläche	Surface		TiCN		TiCN					
Ausführung	Variation									
Typenbeschreibung ab Seite	Type description from page	T2	T2	T2	T2					
d	P	Code	l <sub>1</sub>	l <sub>2</sub>	l <sub>2</sub>	l <sub>3</sub>	d <sub>2</sub>	a	Verfügbarkeit Availability	
	mm				SSP**					
M 2	0,4	02	45	6		10	2,8	2,1	1,60	
M 2,5	0,45	02,5	50	9		14	2,8	2,1	2,05	
M 3	0,5	03	56	10	6	18	3,5	2,7	2,50	x
M 4	0,7	04	63	12	7	23	4,5	3,4	3,30	x
M 5	0,8	05	70	14	9	25	6,0	4,9	4,20	x
M 6	1	06	80	17	10	30	6,0	4,9	5,00	x
M 8	1,25	08	90	18	12	35	8,0	6,2	6,80	x
M 10	1,5	10	100	20	14	39	10,0	8,0	8,50	x

x = ab Lager, Zwischenverkauf vorbehalten  
o = nur solange Lagervorrat vorhanden  
x = normally ex stock  
o = available while stocks last

\*\* SSP = Steilspirale  
\*\* SSP = quick spiral

M



		110 276 Dulofix Ni	110 277 Spiralo 25 Ni	110 278 Dulofix Ti	110 279 Spiralo 25 Ti	110 291 Spiralo 15 Ti-AZ				
		6H / ISO2 B 5	6H / ISO2 C 3	6H / ISO2 B 5	6H / ISO2 C 3	6HX C 3				
		Nickellegierungen Nickel alloys 5.25			Titanlegierungen Titanium alloys 5.26					
		<input type="checkbox"/>	<input type="checkbox"/>	<input type="checkbox"/>	<input type="checkbox"/>	<input type="checkbox"/>	<input type="checkbox"/>	<input type="checkbox"/>	<input type="checkbox"/>	<input type="checkbox"/>
				Nit	Nit	Nit				
						ausgesetzte Zähne Interrupted teeth				
		T2	T2	T2	T2	T2				
d	P mm	Verfügbarkeit Availability								
M 2	0,4	x	x	x	x					
M 2,5	0,45	x	x	x	x					
M 3	0,5	x	x	x	x	x				
M 4	0,7	x	x	x	x	x				
M 5	0,8	x	x	x	x	x				
M 6	1	x	x	x	x	x				
M 8	1,25	x	x	x	x	x				
M 10	1,5	x	x	x	x	x				

x = ab Lager, Zwischenverkauf vorbehalten  
o = nur solange Lagervorrat vorhanden  
x = normally ex stock  
o = available while stocks last



M

**Metrisches ISO-Regelgewinde DIN 13**  
Baumaße DIN 376, Überlaufschaft  
**ISO Metric Coarse Threads, DIN 13**  
Dimensions DIN 376, Reduced shank

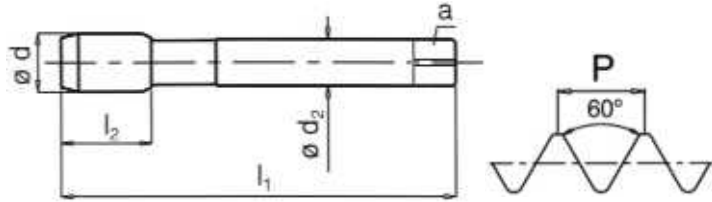

Katalog Nr. Bezeichnung	Catalogue No. Name	110 300 Hahnreiter	110 301 Hahnreiter 6G	110 304 Hahnreiter LH	110 305 Dulofix	110 310 Dulofix TiN													
Toleranz	Tolerance	6H / ISO2	6G / ISO3	6H / ISO2	6H / ISO2	6H / ISO2													
Anschnittform	Chamfer form	C	C	C	B	B													
Anschnittlänge, Gang	Chamfer length, threads	2-3	2-3	2-3	4-5	4-5													
für Bohrungsart	For holes																		
Sonderwerkstoff	Special material																		
Zerspanungsgruppe, siehe Ausklappseite links	Machinability-group, See folder left page	P <input type="checkbox"/> <input type="checkbox"/> <input type="checkbox"/> <input type="checkbox"/>	P <input type="checkbox"/> <input type="checkbox"/> <input type="checkbox"/> <input type="checkbox"/>	P <input type="checkbox"/> <input type="checkbox"/> <input type="checkbox"/> <input type="checkbox"/>	P <input type="checkbox"/> <input type="checkbox"/> <input type="checkbox"/> <input type="checkbox"/> N <input type="checkbox"/>	P <input type="checkbox"/> <input type="checkbox"/> <input type="checkbox"/> <input type="checkbox"/> N <input type="checkbox"/>													
Oberfläche	Surface					TiN													
Ausführung	Variation		Aufmaß Oversize	Links Left hand															
Typenbeschreibung ab Seite	Type description from page	T2	T2	T2	T2	T2													
d	P	Code	l <sub>1</sub>	l <sub>2</sub>	d <sub>2</sub>	a		Verfügbarkeit Availability											
mm																			
M 3	0,5	03	56	10	2,2	2,50		x					x						
M 3,5	0,6	03,5	56	11	2,5	2,1	2,90						x						
M 4	0,7	04	63	11	2,8	2,1	3,30	x					x						
M 5	0,8	05	70	15	3,5	2,7	4,20	x					x						
M 6	1	06	80	17	4,5	3,4	5,00	x	x				x						
M 8	1,25	08	90	20	6,0	4,9	6,80	x	x				x						
M 9	1,25	09	90	17	7,0	5,5	7,80	x					x						
M 10	1,5	10	100	20	7,0	5,5	8,50	x	x				x						
M 12	1,75	12	110	22	9,0	7,0	10,20	x	x				x						x
M 14	2	14	110	25	11,0	9,0	12,00	x					x						x
M 16	2	16	110	25	12,0	9,0	14,00	x	x				x						x
M 18	2,5	18	125	32	14,0	11,0	15,50	x					x						x
M 20	2,5	20	140	32	16,0	12,0	17,50	x	x				x						x
M 22	2,5	22	140	32	18,0	14,5	19,50	x					x						x
M 24	3	24	160	36	18,0	14,5	21,00	x					x						x
M 27	3	27	160	36	20,0	16,0	24,00	x					x						x
M 30	3,5	30	180	40	22,0	18,0	26,50	x					x						x
M 33	3,5	33	180	40	25,0	20,0	29,50	x					x						x
M 36	4	36	200	45	28,0	22,0	32,00	x					x						x
M 39	4	39	200	45	32,0	24,0	35,00	x					x						x
M 42	4,5	42	200	50	32,0	24,0	37,50	x					x						x
M 45	4,5	45	220	50	36,0	29,0	40,50	x					x						x
M 48	5	48	250	56	36,0	29,0	43,00	x					x						
M 52	5	52	250	56	40,0	32,0	47,00	x					x						

Größere Ø auf Anfrage.  
Bigger Ø on request.

x = ab Lager, Zwischenverkauf vorbehalten  
o = nur solange Lagervorrat vorhanden  
x = normally ex stock  
o = available while stocks last



M

**Metrisches ISO-Regelgewinde DIN 13**  
Baumaße DIN 376, Überlaufschaft  
**ISO Metric Coarse Threads, DIN 13**  
Dimensions DIN 376, Reduced shank

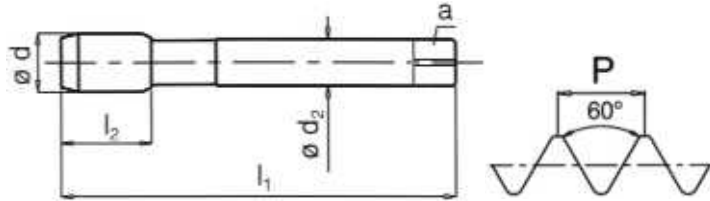

Katalog Nr. Bezeichnung	Catalogue No. Name	110 323 Spiralo 15 AZ	110 326 Spiralo 35	110 335 Spiralo 35 TiN	110 396 Spiralo 35 TiCN	110 336 Spiralo 35 VAP								
Toleranz	Tolerance	6H / ISO2	6H / ISO2	6H / ISO2	6H / ISO2	6H / ISO2								
Anschnittform	Chamfer form	C	C	C	C	C								
Anschnittlänge, Gang	Chamfer length, threads	2-3	2-3	2-3	2-3	2-3								
für Bohrungsart	For holes													
Sonderwerkstoff	Special material	weiches Material soft material 1.1.0 / 3.20 / 4.14												
Zerspanungsgruppe, siehe Ausklappseite links	Machinability-group, See folder left page	<input type="checkbox"/> P <input type="checkbox"/> <input type="checkbox"/> <input checked="" type="checkbox"/> N <input type="checkbox"/>	<input type="checkbox"/> P <input type="checkbox"/> <input type="checkbox"/> <input checked="" type="checkbox"/> N <input type="checkbox"/>	<input type="checkbox"/> P <input type="checkbox"/> <input type="checkbox"/> <input checked="" type="checkbox"/> N <input type="checkbox"/>	<input type="checkbox"/> P <input type="checkbox"/> <input type="checkbox"/> <input checked="" type="checkbox"/> N <input type="checkbox"/>	<input type="checkbox"/> P <input type="checkbox"/> <input type="checkbox"/> <input checked="" type="checkbox"/> N <input type="checkbox"/>								
Oberfläche	Surface			TiN	TiCN	VAP								
Ausführung	Variation													
Typenbeschreibung ab Seite	Type description from page	T2	T2	T2	T2	T2								
d	P	Code	l <sub>1</sub>	l <sub>2</sub>	l <sub>2</sub>	d <sub>2</sub>	a	Verfügbarkeit Availability						
	mm				SSP**									
M 3	0,5	03	56	10	6	2,2								
M 3,5	0,6	03,5	56	11	6	2,5	2,1							
M 4	0,7	04	63	11	7	2,8	2,1							
M 5	0,8	05	70	15	9	3,5	2,7							
M 6	1	06	80	17	10	4,5	3,4							
M 8	1,25	08	90	20	13	6,0	4,9							
M 10	1,5	10	100	20	14	7,0	5,5							
M 12	1,75	12	110	22	16	9,0	7,0							
M 14	2	14	110	25	20	11,0	9,0							
M 16	2	16	110	25	20	12,0	9,0							
M 18	2,5	18	125	32	25	14,0	11,0							
M 20	2,5	20	140	32	25	16,0	12,0							
M 22	2,5	22	140	32	25	18,0	14,5							
M 24	3	24	160	36	30	18,0	14,5							
M 27	3	27	160	36	30	20,0	16,0							
M 30	3,5	30	180	40	35	22,0	18,0							
M 33	3,5	33	180	40	35	25,0	20,0							
M 36	4	36	200	45	40	28,0	22,0							
M 39	4	39	200	45	40	32,0	24,0							
M 42	4,5	42	200	50	45	32,0	24,0							
M 45	4,5	45	220	50	45	36,0	29,0							

x = ab Lager, Zwischenverkauf vorbehalten  
o = nur solange Lagervorrat vorhanden  
x = normally ex stock  
o = available while stocks last

\*\* SSP = Steilspirale  
\*\* SSP = quick spiral

M



	110 329 Spiralo 35 6G	110 333 Spiralo 35 +0,1	110 331 Spiralo 35 E	110 332 Spiralo 35 TS	110 334 Spiralo 35 AZ	110 338 Spiralo 35 LH	110 327 Spiralo 45 ZB TiN/VAP	110 353 Spiralo 48 TS TiN	110 354 Spiralo 48 TS TiN
	6G / ISO3 C 2-3	6H +0,1 C 2-3	6H / ISO2 E 1,5-2	6H / ISO2 C 2-3	6H / ISO2 C 2-3	6H / ISO2 C 2-3	6H / ISO2 C 2-3	6H / ISO2 C 2-3	6G / ISO3 C 2-3
	Aufmaß Oversize	Aufmaß Oversize	Anschn.extra kurz Chamf.extra short	tiefe Sacklöcher Deep blind holes	ausgesetzte Zähne Interrupted teeth	Links left hand	TiN/VAP	TiN	TiN
	T2	T2	T2	T2	T2	T2	T2	T2	T2
d	P mm	Verfügbarkeit Availability							
M 3	0,5								
M 3,5	0,6								
M 4	0,7								
M 5	0,8								
M 6	1				x				
M 8	1,25	x			x				
M 10	1,5	x			x				
M 12	1,75	x	x	x	x	x	x	x	x
M 14	2	x			x	x	x	x	x
M 16	2	x	x	x	x	x	x	x	x
M 18	2,5	x			x	o			
M 20	2,5	x	x	x	x	x	x	x	x
M 22	2,5	x			x				
M 24	3	x	x		x	o	x	x	x
M 27	3						x		
M 30	3,5						x		
M 33	3,5						x		
M 36	4						x		
M 39	4								
M 42	4,5						x		
M 45	4,5								

x = ab Lager, Zwischenverkauf vorbehalten  
o = nur solange Lagervorrat vorhanden  
x = normally ex stock  
o = available while stocks last

M

**Metrisches ISO-Regelgewinde DIN 13**  
Baumaße DIN 376, Überlaufschaft  
**ISO Metric Coarse Threads, DIN 13**  
Dimensions DIN 376, Reduced shank

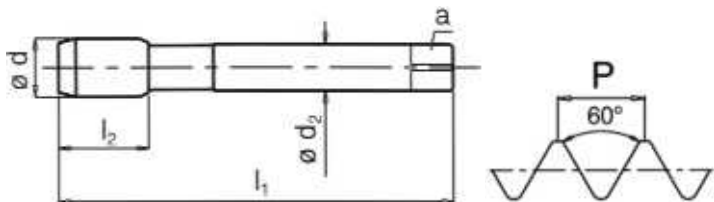

Katalog Nr. Bezeichnung	Catalogue No. Name	110 352 Spiralo 45	110 380 Hahnreiter MS	110 383 Hahnreiter MS	110 381 Gussfix	110 382 Gussfix TiN		
Toleranz	Tolerance	6H / ISO2	6H / ISO2	6H / ISO2	6HX	6HX		
Anschnittform	Chamfer form	C	C	E	C	C		
Anschnittlänge, Gang	Chamfer length, threads	2-3	2-3	1,5-2	2-3	2-3		
für Bohrungsart	For holes							
Sonderwerkstoff	Special material	Aluminium	Messing Brass	Messing Brass	Grauguss Grey cast iron	Grauguss Grey cast iron		
Zerspanungsgruppe, siehe Ausklappseite links	Machinability-group, See folder left page	4.14	3.21	3.21	2.11	2.11 / 3.24 / 4.17		
Oberfläche	Surface	<input type="checkbox"/> <input type="checkbox"/> <input type="checkbox"/> <input checked="" type="checkbox"/> <input type="checkbox"/>	<input type="checkbox"/> <input type="checkbox"/> <input type="checkbox"/> <input checked="" type="checkbox"/> <input type="checkbox"/>	<input type="checkbox"/> <input type="checkbox"/> <input type="checkbox"/> <input checked="" type="checkbox"/> <input type="checkbox"/>	<input type="checkbox"/> <input checked="" type="checkbox"/> <input type="checkbox"/> <input type="checkbox"/> <input type="checkbox"/>	<input type="checkbox"/> <input checked="" type="checkbox"/> <input type="checkbox"/> <input type="checkbox"/> <input type="checkbox"/>		
Ausführung	Variation				Nit	TiN		
Typenbeschreibung ab Seite	Type description from page	T2	T2	T2	T2	T2		
d	P	Code	l <sub>1</sub>	l <sub>2</sub>	l <sub>2</sub>	d <sub>2</sub>	a	Verfügbarkeit Availability
	mm				SSP**			
M 3	0,5	03	56	10	6	2,2	2,50	
M 3,5	0,6	03,5	56	11	6	2,5 2,1	2,90	
M 4	0,7	04	63	11	7	2,8 2,1	3,30	
M 5	0,8	05	70	15	9	3,5 2,7	4,20	
M 6	1	06	80	17	10	4,5 3,4	5,00	x
M 8	1,25	08	90	20	13	6,0 4,9	6,80	x
M 10	1,5	10	100	20	14	7,0 5,5	8,50	x
M 12	1,75	12	110	22	16	9,0 7,0	10,20	x
M 14	2	14	110	25	20	11,0 9,0	12,00	x
M 16	2	16	110	25	20	12,0 9,0	14,00	x
M 18	2,5	18	125	32	25	14,0 11,0	15,50	
M 20	2,5	20	140	32	25	16,0 12,0	17,50	x
M 22	2,5	22	140	32	25	18,0 14,5	19,50	x
M 24	3	24	160	36	30	18,0 14,5	21,00	x
M 27	3	27	160	36	30	20,0 16,0	24,00	x
M 30	3,5	30	180	40	35	22,0 18,0	26,50	x
M 33	3,5	33	180	40	35	25,0 20,0	29,50	
M 36	4	36	200	45	40	28,0 22,0	32,00	
M 39	4	39	200	45	40	32,0 24,0	35,00	
M 42	4,5	42	200	50	45	32,0 24,0	37,50	
M 45	4,5	45	220	50	45	36,0 29,0	40,50	

x = ab Lager, Zwischenverkauf vorbehalten  
o = nur solange Lagervorrat vorhanden  
x = normally ex stock  
o = available while stocks last

\*\* SSP = Steilspirale  
\*\* SSP = quick spiral



M



	110 360 Nirofix	110 366 Nirofix TiN	110 361 Nirofix AZ	110 369 Nirofix-Z STY/WC	110 363 Nirofix 35	110 367 Nirofix 35 TiN	110 365 Nirofix 35 TS	110 368 Nirofix 48 STY/WC	
	6H / ISO2 B 4-5	6H / ISO2 B 4-5	6H / ISO2 B 4-5	6HX B 4-5	6H / ISO2 C 2-3	6H / ISO2 C 2-3	6H / ISO2 C 2-3	6HX C 2-3	
	rostfreie Stähle Stainless steels 1.9.4			rostfreie Stähle Stainless steels 1.9.5 / 3.20	rostfreie Stähle Stainless steels 1.9.4			rostfreie Stähle Stainless steels 1.9.5 / 3.20	
	<input type="checkbox"/> M <input type="checkbox"/> P <input type="checkbox"/> M <input type="checkbox"/> K <input type="checkbox"/>	<input type="checkbox"/> M <input type="checkbox"/> P <input type="checkbox"/> M <input type="checkbox"/> K <input type="checkbox"/>	<input type="checkbox"/> M <input type="checkbox"/> P <input type="checkbox"/> M <input type="checkbox"/> K <input type="checkbox"/>	<input type="checkbox"/> P <input type="checkbox"/> M <input type="checkbox"/> N <input type="checkbox"/>	<input type="checkbox"/> M <input type="checkbox"/> P <input type="checkbox"/> M <input type="checkbox"/> K <input type="checkbox"/>	<input type="checkbox"/> M <input type="checkbox"/> P <input type="checkbox"/> M <input type="checkbox"/> K <input type="checkbox"/>	<input type="checkbox"/> M <input type="checkbox"/> P <input type="checkbox"/> M <input type="checkbox"/> K <input type="checkbox"/>	<input type="checkbox"/> P <input type="checkbox"/> M <input type="checkbox"/> N <input type="checkbox"/>	
	VAP	TiN	VAP	STY/WC	VAP	TiN	VAP	STY/WC	
			ausgesetzte Zähne Interrupted teeth				tiefe Sacklöcher Deep blind holes		
	T2	T2	T2	T2	T2	T2	T2	T2	T2
d	P mm	Verfügbarkeit Availability							
M 3	0,5								
M 3,5	0,6								
M 4	0,7								
M 5	0,8								
M 6	1								
M 8	1,25					x	x	x	
M 10	1,5					x	x	x	
M 12	1,75	x	x	x	x	x	x	x	x
M 14	2	x	x	x	x	x	x	x	x
M 16	2	x	x	x	x	x	x	x	x
M 18	2,5	x	x	x	x	x	x	x	
M 20	2,5	x	x	x	x	x	x	x	x
M 22	2,5	x	x	x	x	x	x	x	
M 24	3	x	x	x	x	x	x	x	x
M 27	3	x	x	x	x	x	x	x	
M 30	3,5	x	x			x	x		
M 33	3,5								
M 36	4	x	x			x	x		
M 39	4								
M 42	4,5								
M 45	4,5								

x = ab Lager, Zwischenverkauf vorbehalten  
o = nur solange Lagervorrat vorhanden  
x = normally ex stock  
o = available while stocks last

M

**Metrisches ISO-Regelgewinde DIN 13**  
Baumaße DIN 376, Überlaufschaft  
**ISO Metric Coarse Threads, DIN 13**  
Dimensions DIN 376, Reduced shank

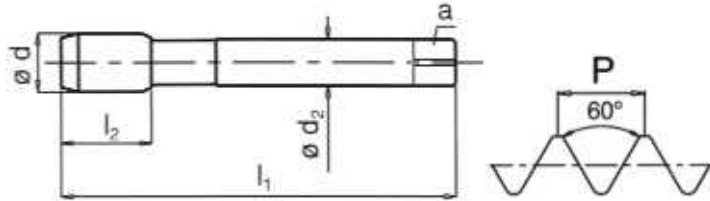

Katalog Nr. Bezeichnung	Catalogue No. Name	110 370 Dulofix VS	110 371 Spiralo 35 VS	110 356 Multifix	110 357 Multifix 35	110 397 Spiralo 15 HF TiCN			
Toleranz	Tolerance	6H / ISO2	6H / ISO2	6H / ISO2	6H / ISO2	6HX			
Anschnittform	Chamfer form	B	C	B	C	C			
Anschnittlänge, Gang	Chamfer length, threads	4-5	2-3	4-5	2-3	2-3			
für Bohrungsart	For holes								
Sonderwerkstoff	Special material	Vergütungsstähle Heat-treatable steels		Werkzeugstähle Toolsteels 1.7 / 3.23		*** 1.7 / 1.8			
Zerspanungsgruppe, siehe Ausklappseite links	Machinability-group, See folder left page	<input type="checkbox"/> P <input type="checkbox"/> <input type="checkbox"/> <input type="checkbox"/> <input type="checkbox"/>	<input type="checkbox"/> P <input type="checkbox"/> <input type="checkbox"/> <input type="checkbox"/> <input type="checkbox"/>	<input type="checkbox"/> P <input type="checkbox"/> <input type="checkbox"/> <input type="checkbox"/> <input type="checkbox"/> <input type="checkbox"/> <input type="checkbox"/> <input type="checkbox"/> <input type="checkbox"/>	<input type="checkbox"/> P <input type="checkbox"/> <input type="checkbox"/> <input type="checkbox"/> <input type="checkbox"/> <input type="checkbox"/> <input type="checkbox"/> <input type="checkbox"/> <input type="checkbox"/>	<input type="checkbox"/> M <input type="checkbox"/> K <input type="checkbox"/> <input type="checkbox"/>			
Oberfläche	Surface			Stygian	Stygian	TiCN			
Ausführung	Variation					kurze Späne short chips			
Typenbeschreibung ab Seite	Type description from page	T2	T2	T2	T2	T2			
d	P mm	Code	l <sub>1</sub>	l <sub>2</sub>	l <sub>2</sub> SSP**	d <sub>2</sub>	a		Verfügbarkeit Availability
M 3	0,5	03	56	10	6	2,2	2,50		
M 3,5	0,6	03,5	56	11	6	2,5	2,1	2,90	
M 4	0,7	04	63	11	7	2,8	2,1	3,30	
M 5	0,8	05	70	15	9	3,5	2,7	4,20	
M 6	1	06	80	17	10	4,5	3,4	5,00	
M 8	1,25	08	90	20	13	6,0	4,9	6,80	
M 10	1,5	10	100	20	14	7,0	5,5	8,50	
M 12	1,75	12	110	22	16	9,0	7,0	10,20	x
M 14	2	14	110	25	20	11,0	9,0	12,00	x
M 16	2	16	110	25	20	12,0	9,0	14,00	x
M 18	2,5	18	125	32	25	14,0	11,0	15,50	
M 20	2,5	20	140	32	25	16,0	12,0	17,50	x
M 22	2,5	22	140	32	25	18,0	14,5	19,50	
M 24	3	24	160	36	30	18,0	14,5	21,00	
M 27	3	27	160	36	30	20,0	16,0	24,00	
M 30	3,5	30	180	40	35	22,0	18,0	26,50	
M 33	3,5	33	180	40	35	25,0	20,0	29,50	
M 36	4	36	200	45	40	28,0	22,0	32,00	x
M 39	4	39	200	45	40	32,0	24,0	35,00	
M 42	4,5	42	200	50	45	32,0	24,0	37,50	
M 45	4,5	45	220	50	45	36,0	29,0	40,50	

\*\*\*Geometrie bildet bei geeigneten Materialien kurze Späne.  
Für das sichere Ausspülen ist eine Hochdruck-Kühlung unerlässlich.  
\*\*\*Geometry creates short chips machining suitable materials.  
High-pressure cooling is essential for safe chip evacuation

x = ab Lager, Zwischenverkauf vorbehalten  
o = nur solange Lagervorrat vorhanden  
x = normally ex stock  
o = available while stocks last

\*\* SSP = Steilspirale  
\*\* SSP = quick spiral

# Maschinen-Gewindebohrer

## Machine Taps

# HAHNREITER HSS-EP

Pulvermetallurgisch erzeugter Schnellstahl / Made from powder metallurgy material

M



	110 373 Dulofix HF	110 392 Dulofix HF TiCN	110 374 Spiralo 35 HF	110 393 Spir.35 HF TiCN	110 376 Dulofix Ni	110 377 Spiralo 25 Ni	110 378 Dulofix Ti	110 379 Spiralo 25 Ti	110 391 Spiralo 15 Ti-AZ
	6H / ISO2 B 4-5	6H / ISO2 B 4-5	6H / ISO2 C 2-3	6H / ISO2 C 2-3	6H / ISO2 B 5	6H / ISO2 C 3	6H / ISO2 B 5	6H / ISO2 C 3	6HX C 3
	hochfeste Stähle Hard materials 1.4.3/1.5.3 / 1.6.3/1.8			Nickellegierungen Nickel alloys 5.25		Titanlegierungen Titanium alloys 5.26			
	<input type="checkbox"/> P <input type="checkbox"/> <input type="checkbox"/> <input type="checkbox"/> <input type="checkbox"/>	<input type="checkbox"/> P <input type="checkbox"/> <input type="checkbox"/> <input type="checkbox"/> <input type="checkbox"/>	<input type="checkbox"/> P <input type="checkbox"/> <input type="checkbox"/> <input type="checkbox"/> <input type="checkbox"/>	<input type="checkbox"/> P <input type="checkbox"/> <input type="checkbox"/> <input type="checkbox"/> <input type="checkbox"/>	<input type="checkbox"/> <input type="checkbox"/> <input type="checkbox"/> <input type="checkbox"/> <input type="checkbox"/> S	<input type="checkbox"/> <input type="checkbox"/> <input type="checkbox"/> <input type="checkbox"/> <input type="checkbox"/> S	<input type="checkbox"/> <input type="checkbox"/> <input type="checkbox"/> <input type="checkbox"/> <input type="checkbox"/> S	<input type="checkbox"/> <input type="checkbox"/> <input type="checkbox"/> <input type="checkbox"/> <input type="checkbox"/> S	<input type="checkbox"/> <input type="checkbox"/> <input type="checkbox"/> <input type="checkbox"/> <input type="checkbox"/> S
		TiCN		TiCN			Nit	Nit	Nit
									ausgesetzte Zähne Interrupted teeth
	T2	T2	T2	T2	T2	T2	T2	T2	T2
d	P mm	Verfügbarkeit Availability							
M 3	0,5								
M 3,5	0,6								
M 4	0,7								
M 5	0,8								
M 6	1								
M 8	1,25								
M 10	1,5								
M 12	1,75	x	x	x	x	x	x	x	x
M 14	2	x	x	x	x	x	x	x	x
M 16	2	x	x	x	x	x	x	x	x
M 18	2,5	x	x	x	x	x	x	x	
M 20	2,5	x	x	x	x	x	x	x	
M 22	2,5								
M 24	3	x	x	x	x				
M 27	3	x	x	x	x				
M 30	3,5	x	x	x	x				
M 33	3,5								
M 36	4	x	x	x	x				
M 39	4								
M 42	4,5								
M 45	4,5								

x = ab Lager, Zwischenverkauf vorbehalten  
o = nur solange Lagervorrat vorhanden  
x = normally ex stock  
o = available while stocks last

M

Metrisches ISO-Regelgewinde DIN 13

Baumaße Werksnorm

ISO Metric Coarse Threads, DIN 13

Dimensions manuf. standard

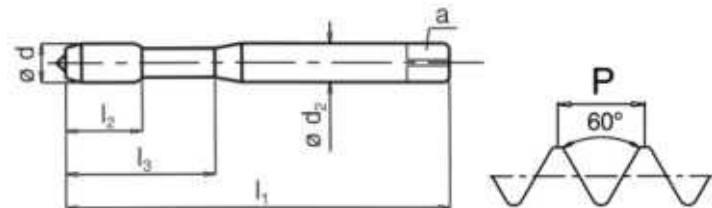

Katalog Nr. Bezeichnung	Catalogue No. Name	110 286 Dulofix SYNC TiN	110 287 Spiralo 40 SYNC TiN	110 386 Dulofix SYNC TiN	110 387 Spiralo 40 SYNC TiN									
Toleranz	Tolerance	6HX	6HX	6HX	6HX									
Anschnittform	Chamfer form	B	C	B	C									
Anschnittlänge, Gang	Chamfer length, threads	4-5	2-3	4-5	2-3									
für Bohrungsart	For holes													
Sonderwerkstoff	Special material	Universal für langspanende Werkstoffe bis 1.100 N/mm <sup>2</sup> universal for long chipping materials up to 1.100 N/mm <sup>2</sup>												
Zerspanungsgruppe, siehe Ausklappseite links	Machinability-group, See folder left page	P M K N S P M K N S P M K N S P M K N S												
Oberfläche	Surface	TiN	TiN	TiN	TiN									
Ausführung	Variation	Schaft h6, mit Weldon Fläche, nur für CNC shank h6, with Weldon flat, for CNC only												
Typenbeschreibung ab Seite	Type description from page	T2	T2	T2	T2									
d	P	Code	l <sub>1</sub>	l <sub>2</sub>	l <sub>2</sub>	l <sub>3</sub>	d <sub>2</sub>	a	Verfügbarkeit Availability					
mm				SSP**										
<b>Baumaße Werksnorm, verstärkter Schaft bis M 16</b> Dimensions manuf. standard, up to M 16 reinforced shank														
M 3	0,5	03	70	7	5	22	6,0	4,9	2,50	x	x			
M 4	0,7	04	70	10	7	30	6,0	4,9	3,30	x	x			
M 5	0,8	05	70	11	8	30	6,0	4,9	4,20	x	x			
M 6	1	06	80	14	10	35	6,0	4,9	5,00	x	x			
M 8	1,25	08	90	16	13	40	8,0	6,2	6,80	x	x			
M 10	1,5	10	100	20	14	44	10,0	8,0	8,50	x	x			
M 12	1,75	12	110	19	17	50	12,0	9,0	10,20	x	x			
M 14	2	14	110	28	20	56	14,0	11,0	12,00	x	x			
M 16	2	16	110	28	20	56	16,0	12,0	14,00	x	x			
<b>Baumaße DIN 376, Überlaufschaft</b> Dimensions DIN 376, Reduced shank														
M 20	2,5	20	140	32	25	16,0	12,0	17,50			x	x		
M 24	3	24	160	36	30	18,0	14,5	21,00			x	x		

x = ab Lager, Zwischenverkauf vorbehalten  
o = nur solange Lagervorrat vorhanden  
x = normally ex stock  
o = available while stocks last

\*\* SSP = Steilschneidspiral  
\*\* SSP = quick spiral

M

Metrisches ISO-Regelgewinde DIN 13

Baumaße Werksnorm

ISO Metric Coarse Threads, DIN 13

Dimensions manuf. standard

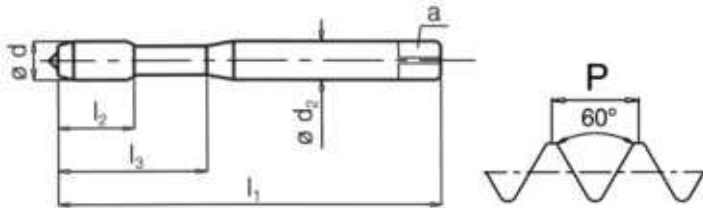

Katalog Nr. Bezeichnung	Catalogue No. Name	110 288 Dulofix SYNC IKZ-R	110 289 Spiralo 40 SYNC IKZ	110 388 Dulofix SYNC IKZ-R	110 389 Spiralo 40 SYNC IKZ																				
Toleranz	Tolerance	6HX	6HX	6HX	6HX																				
Anschnittform	Chamfer form	B	C	B	C																				
Anschnittlänge, Gang	Chamfer length, threads	4-5	2-3	4-5	2-3																				
für Bohrungsart	For holes																								
Sonderwerkstoff	Special material	Universal für langspanende Werkstoffe bis 1.100 N/mm <sup>2</sup> universal for long chipping materials up to 1.100 N/mm <sup>2</sup>																							
Zerspanungsgruppe, siehe Ausklappseite links	Machinability-group, See folder left page	<table border="1"> <tr> <td>P</td><td>M</td><td>K</td><td>N</td><td>S</td> <td>P</td><td>M</td><td>K</td><td>N</td><td>S</td> <td>P</td><td>M</td><td>K</td><td>N</td><td>S</td> <td>P</td><td>M</td><td>K</td><td>N</td><td>S</td> </tr> </table>				P	M	K	N	S	P	M	K	N	S	P	M	K	N	S	P	M	K	N	S
P	M	K	N	S	P	M	K	N	S	P	M	K	N	S	P	M	K	N	S						
Oberfläche	Surface	TiN	TiN	TiN	TiN																				
Ausführung	Variation	Schaft h6, mit Weldon Fläche, nur für CNC shank h6, with Weldon flat, for CNC only																							
Typenbeschreibung ab Seite	Type description from page	T2	T2	T2	T2																				
d mm	P Code	l <sub>1</sub> l <sub>2</sub> l <sub>3</sub> d <sub>2</sub> a		Verfügbarkeit Availability																					

Baumaße Werksnorm, verstärkter Schaft bis M 16  
Dimensions manuf. standard, up to M 16 reinforced shank

M	d	P	l <sub>1</sub>	l <sub>2</sub>	l <sub>3</sub>	d <sub>2</sub>	a	l <sub>1</sub>
M 3	0,5	03	70	7	5	22	6,0	4,9
M 4	0,7	04	70	10	7	30	6,0	4,9
M 5	0,8	05	70	11	8	30	6,0	4,9
M 6	1	06	80	14	10	35	6,0	4,9
M 8	1,25	08	90	16	13	40	8,0	6,2
M 10	1,5	10	100	20	14	44	10,0	8,0
M 12	1,75	12	110	19	17	50	12,0	9,0
M 14	2	14	110	28	20	56	14,0	11,0
M 16	2	16	110	28	20	56	16,0	12,0

Baumaße DIN 376, Überlaufschaft  
Dimensions DIN 376, Reduced shank

M	d	P	l <sub>1</sub>	l <sub>2</sub>	l <sub>3</sub>	d <sub>2</sub>	a	l <sub>1</sub>
M 20	2,5	20	140	32	25	16,0	12,0	17,50
M 24	3	24	160	36	30	18,0	14,5	21,00

x = ab Lager, Zwischenverkauf vorbehalten  
o = nur solange Lagervorrat vorhanden  
x = normally ex stock  
o = available while stocks last

\*\* SSP = Steilspirale  
\*\* SSP = quick spiral



M

**Metrisches ISO-Regelgewinde DIN 13**  
Baumaße DIN 371, verstärkter Schaft  
**ISO Metric Coarse Threads, DIN 13**  
Dimensions DIN 371, Reinforced shank

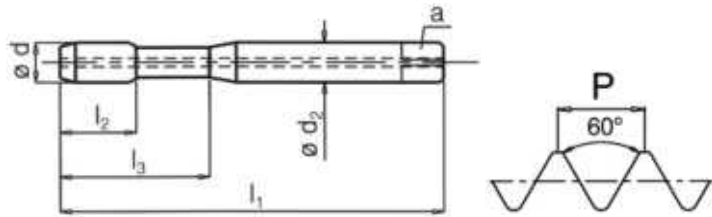

Katalog Nr. Bezeichnung	Catalogue No. Name	110 402 Spiralo 15 IKZ	110 403 Spiralo 15 IKZ TiN	110 404 Spiralo 35 IKZ	110 405 Spiralo 35 IKZ TiN	110 406 Gussfix IKZ													
Toleranz	Tolerance	6H / ISO2	6H / ISO2	6H / ISO2	6H / ISO2	6HX													
Anschnittform	Chamfer form	C	C	C	C	C													
Anschnittlänge, Gang	Chamfer length, threads	2-3	2-3	2-3	2-3	2-3													
für Bohrungsart	For holes																		
Sonderwerkstoff	Special material					Grauguss Grey cast iron 2.11													
Zerspanungsgruppe, siehe Ausklappseite links	Machinability-group, See folder left page	<input type="checkbox"/> P <input type="checkbox"/> N	<input type="checkbox"/> P <input type="checkbox"/> M <input type="checkbox"/> K <input type="checkbox"/> N	<input type="checkbox"/> P <input type="checkbox"/> N	<input type="checkbox"/> P <input type="checkbox"/> M <input type="checkbox"/> N	<input type="checkbox"/> K													
Oberfläche	Surface		TiN		TiN	Nit													
Ausführung	Variation	axialer Kühlmittelaustritt internal coolant supply, axial exit																	
Typenbeschreibung ab Seite	Type description from page	T2	T2	T2	T2	T2													
d	P	Code	l <sub>1</sub>	l <sub>2</sub>	l <sub>2</sub>	l <sub>3</sub>	d <sub>2</sub>	a	Verfügbarkeit Availability										
	mm				SSP**														
M 4	0,7	04	63	12	7	23	4,5	3,4	3,30	x	x	x	x	x	x				
M 5	0,8	05	70	14	9	25	6,0	4,9	4,20	x	x	x	x	x	x				
M 6	1	06	80	17	10	30	6,0	4,9	5,00	x	x	x	x	x	x				
M 8	1,25	08	90	18	12	35	8,0	6,2	6,80	x	x	x	x	x	x				
M 10	1,5	10	100	20	14	39	10,0	8,0	8,50	x	x	x	x	x	x				

x = ab Lager, Zwischenverkauf vorbehalten  
o = nur solange Lagervorrat vorhanden  
x = normally ex stock  
o = available while stocks last

\*\* SSP = Steilschneidspiral  
\*\* SSP = quick spiral



M

Metrisches ISO-Regelgewinde DIN 13

Baumaße DIN 376, Überlaufschaft

ISO Metric Coarse Threads, DIN 13

Dimensions DIN 376, Reduced shank

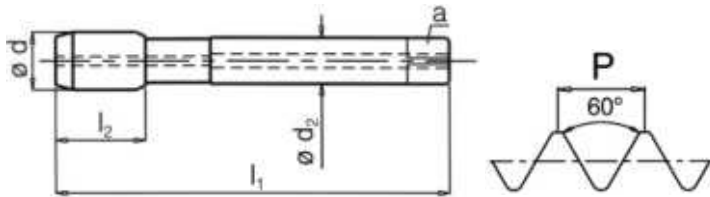

Katalog Nr. Bezeichnung	Catalogue No. Name	110 452 Spiralo 15 IKZ	110 453 Sp. 15 IKZ TiN	110 454 Spiralo 35 IKZ	110 455 Sp. 35 IKZ TiN	110 456 Gussfix IKZ										
Toleranz	Tolerance	6H / ISO2	6H / ISO2	6H / ISO2	6H / ISO2	6HX C										
Anschnittform	Chamfer form	C	C	C	C	C										
Anschnittlänge, Gang	Chamfer length, threads	2-3	2-3	2-3	2-3	2-3										
für Bohrungsart	For holes															
Sonderwerkstoff	Special material					Grauguss Grey cast iron 2.11										
Zerspanungsgruppe, siehe Ausklappseite links	Machinability-group, See folder left page	<input type="checkbox"/> P <input type="checkbox"/> N	<input type="checkbox"/> P <input type="checkbox"/> M <input type="checkbox"/> K <input type="checkbox"/> N	<input type="checkbox"/> P <input type="checkbox"/> N	<input type="checkbox"/> P <input type="checkbox"/> M <input type="checkbox"/> N	<input type="checkbox"/> K										
Oberfläche	Surface		TiN		TiN	Nit										
Ausführung	Variation	axialer Kühlmittelaustritt internal coolant supply, axial exit														
Typenbeschreibung ab Seite	Type description from page	T2	T2	T2	T2	T2										
d	P	Code	l <sub>1</sub>	l <sub>2</sub>	l <sub>2</sub>	d <sub>2</sub>	a	Verfügbarkeit Availability								
	mm				SSP**											
M 12	1,75	12	110	22	16	9,0	7,0	10,20	x	x	x	x	x	x		
M 14	2	14	110	25	20	11,0	9,0	12,00	x	x	x	x	x			
M 16	2	16	110	25	20	12,0	9,0	14,00	x	x	x	x	x			x
M 18	2,5	18	125	32	25	14,0	11,0	15,50								
M 20	2,5	20	140	32	25	16,0	12,0	17,50	x	x	x	x	x			x

x = ab Lager, Zwischenverkauf vorbehalten  
o = nur solange Lagervorrat vorhanden  
x = normally ex stock  
o = available while stocks last

\*\* SSP = Steilspirale  
\*\* SSP = quick spiral

M

HSS-EP



HSS-EP



		110 457			110 458				
		Dulofix HF IKZ-R TiCN			Spiralo 15 HF IKZ TiCN				
		6HX B 4-5			6HX C 2-3				
		höchste Stähle Hard materials 1.4.3 / 1.5.3 / 1.6.3 / 1.8			**				
		<input type="checkbox"/> P <input checked="" type="checkbox"/> M <input checked="" type="checkbox"/> K <input type="checkbox"/>			<input checked="" type="checkbox"/> P <input type="checkbox"/> K <input type="checkbox"/>				
		TiCN			TiCN				
		radialer Kühlmittelaustritt internal coolant supply, radial exit			axialer Kühlmittelaustritt internal coolant supply, axial exit				
		T2			T2				
d	P	Verfügbarkeit		Verfügbarkeit					
	mm	Availability		Availability					
M 12	1,75	x		x					
M 14	2	x		x					
M 16	2	x		x					
M 18	2,5								
M 20	2,5	x		x					
		<p>**Geometrie bildet bei geeigneten Materialien kurze Späne. Für das sichere Ausspülen ist eine Hochdruck-Kühlung unerlässlich. **Geometry creates short chips machining suitable materials. High-pressure cooling is essential for safe chip evacuation</p>							

x = ab Lager, Zwischenverkauf vorbehalten  
o = nur solange Lagervorrat vorhanden  
x = normally ex stock  
o = available while stocks last

M

Metrisches ISO-Regelgewinde DIN 13

doppelte Länge wie DIN 371, verstärkter Schaft

ISO Metric Coarse Threads, DIN 13

double length as DIN 371, Reinforced shank

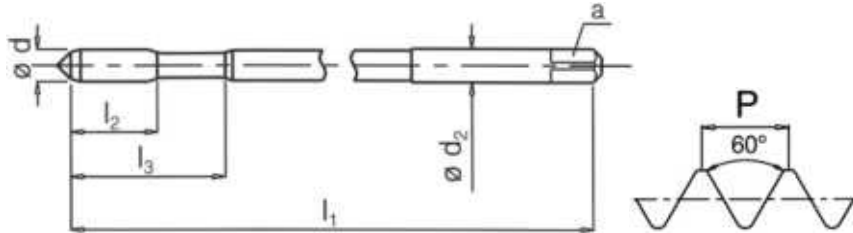

Katalog Nr. Bezeichnung	Catalogue No. Name	110 530 Dulofix ÜL	110 531 Spiralo 35 ÜL	110 532 Gussfix ÜL								
Toleranz	Tolerance	6H / ISO2	6H / ISO2	6H / ISO2								
Anschnittform	Chamfer form	B	C	C								
Anschnittlänge, Gang	Chamfer length, threads	4-5	2-3	2-3								
für Bohrungsart	For holes											
Sonderwerkstoff	Special material											
Zerspanungsgruppe, siehe Ausklappseite links	Machinability-group, See folder left page	<input type="checkbox"/> P <input type="checkbox"/> <input type="checkbox"/> N <input type="checkbox"/>	<input type="checkbox"/> P <input type="checkbox"/> <input type="checkbox"/> N <input type="checkbox"/>	<input type="checkbox"/> <input type="checkbox"/> K <input type="checkbox"/>								
Oberfläche	Surface			Nit								
Ausführung	Variation	doppelte Länge wie DIN 371, verstärkter Schaft double length as DIN 371, Reinforced shank										
Typenbeschreibung ab Seite	Type description from page	T2	T2	T2								
d	P	Verfügbarkeit										
	mm	Availability										
Code	SSP**											
l <sub>1</sub>	l <sub>2</sub>											
l <sub>3</sub>	d <sub>2</sub>											
a												
M 4	0,7	04	125	12	7	23	4,5	3,4	3,30	x	x	x
M 5	0,8	05	140	14	9	25	6,0	4,9	4,20	x	x	x
M 6	1	06	160	17	10	30	6,0	4,9	5,00	x	x	x
M 8	1,25	08	180	18	12	35	8,0	6,2	6,80			

x = ab Lager, Zwischenverkauf vorbehalten  
o = nur solange Lagervorrat vorhanden  
x = normally ex stock  
o = available while stocks last

\*\* SSP = Steilschneidspiral  
\*\* SSP = quick spiral





M

Metrisches ISO-Regelgewinde DIN 13

Baumaße DIN 357, Überlaufschaft

ISO Metric Coarse Threads, DIN 13

Dimensions DIN 357, Reduced shank

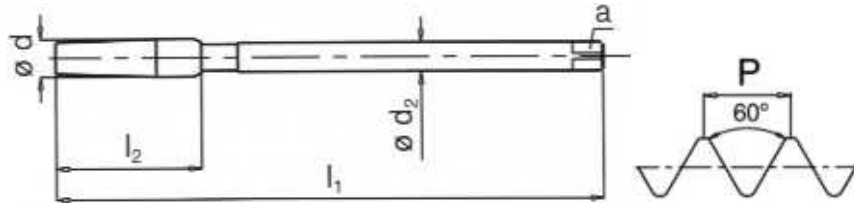

Katalog Nr.	Bezeichnung	Catalogue No.	Name	110 500	Hahnreiter			
Toleranz		Tolerance			6H / ISO2			
Anschnittform		Chamfer form			spezial			
Anschnittlänge, Gang		Chamfer length, threads			≈ 18			
für Bohrungsart		For holes						
Sonderwerkstoff		Special material						
Zerspanungsgruppe, siehe Ausklappseite links		Machinability-group, See folder left page			<input type="checkbox"/> <input type="checkbox"/> <input type="checkbox"/> <input type="checkbox"/>			
Oberfläche		Surface						
Ausführung		Variation			für Muttern for nuts			
d	P mm	Code	l <sub>1</sub>	l <sub>2</sub>	d <sub>2</sub>	a		Verfügbarkeit Availability
M 3	0,5	03	70	22	2,2	2,50		x
M 3,5	0,6	03,5	80	22	2,5	2,1		x
M 4	0,7	04	90	19	2,8	2,1		x
M 5	0,8	05	100	22	3,5	2,7		x
M 6	1	06	110	30	4,5	3,4		x
M 8	1,25	08	125	34	6,0	4,9		x
M 10	1,5	10	140	41	7,0	5,5		x
M 12	1,75	12	180	48	9,0	7,0		x
M 14	2	14	200	56	11,0	9,0		x
M 16	2	16	200	54	12,0	9,0		x
M 18	2,5	18	220	63	14,0	11,0		
M 20	2,5	20	250	70	16,0	12,0		
M 22	2,5	22	280	70	18,0	14,5		
M 24	3	24	280	80	18,0	14,5		
M 27	3	27	315	81	20,0	16,0		o

x = ab Lager, Zwischenverkauf vorbehalten  
o = nur solange Lagervorrat vorhanden  
x = normally ex stock  
o = available while stocks last



- Anschweissenden zum Selbstanschweissen
- Einlötspitzen zum Hart/Weichlöten
- Mit Anzugsgewinde zum Einschrauben
- Fertige Längen
  
- *Nib taps, for butt welding*
- *Nib taps, for brazing*
- *Nib taps, screw-in type*
- *Nut taps with straight or bent shank*

**Bitte fragen Sie uns an !**

***Please send us your enquiries !***

M

Metrisches ISO-Regelgewinde DIN 13

Baumaße DIN 2174 (371), verstärkter Schaft

ISO Metric Coarse Threads, DIN 13

Dimensions DIN 2174 (371), Reinforced shank

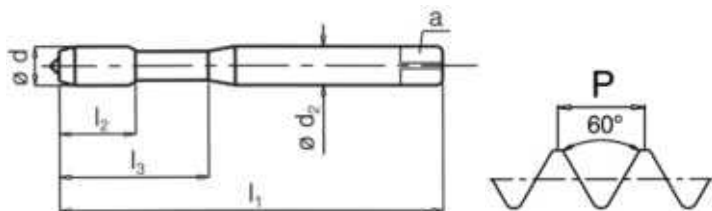

Katalog Nr. Bezeichnung	Catalogue No. Name	110 239 Drückfix	110 240 Drückfix 6G	110 241 Drückfix N	110 242 Drückfix N 6G	110 243 Drückfix TiN	
Toleranz	Tolerance	6HX	6GX	6HX	6GX	6HX	
Anschnittform	Chamfer form	2-3	2-3	2-3	2-3	2-3	
Anschnittlänge, Gang für Bohrungsart	Chamfer length, threads For holes						
Sonderwerkstoff	Special material	Werkstoffe mit min. 10% Bruchdehnung Materials with elongation of min. 10%					
Zerspanungsgruppe, siehe Ausklappseite links	Machinability-group, See folder left page	1) <input type="checkbox"/> P <input type="checkbox"/> <input type="checkbox"/> <input type="checkbox"/> <input checked="" type="checkbox"/> N <input type="checkbox"/> <input type="checkbox"/>					
Oberfläche	Surface					TiN	
Ausführung	Variation		Aufmaß Oversize		Aufmaß Oversize		
Typenbeschreibung ab Seite	Type description from page	T2	T2	T2	T2	T2	
d	P	Verfügbarkeit Availability					
mm	Code						
		l <sub>1</sub>	l <sub>2</sub>	l <sub>3</sub>	d <sub>2</sub>	a	
M 1	0,25 01	40	4	2,5	2,1	0,90	
M 1,2	0,25 01,2	40	5	2,5	2,1	1,10	
M 1,4	0,3 01,4	40	6	2,5	2,1	1,25	
M 1,6	0,35 01,6	40	6	2,5	2,1	1,45	
M 1,7	0,35 01,7	40	7	2,5	2,1	1,55	
M 1,8	0,35 01,8	40	7	2,5	2,1	1,65	
M 2	0,4 02	45	6	10	2,8	2,1	1,85
M 2,5	0,45 02,5	50	9	14	2,8	2,1	2,30
M 3	0,5 03	56	10	18	3,5	2,7	2,80
M 3,5	0,6 03,5	56	11	20	4,0	3,0	3,25
M 4	0,7 04	63	12	23	4,5	3,4	3,70
M 5	0,8 05	70	14	25	6,0	4,9	4,65
M 6	1 06	80	17	30	6,0	4,9	5,55
M 8	1,25 08	90	18	35	8,0	6,2	7,40
M 10	1,5 10	100	20	39	10,0	8,0	9,30

1) nur als Basis für beschichtete Varianten  
only base for coated types

Bis einschl. M 1,4 Toleranz 4HX  
up to M 1,4 incl. tolerance 4HX

x = ab Lager, Zwischenverkauf vorbehalten  
o = nur solange Lagervorrat vorhanden  
x = normally ex stock  
o = available while stocks last

M

HSS-EP



		110 244	110 245	110 246	110 247	110 248		110 249		
		Drückfix 6G TiN	Drückfix N TiN	Drückfix N 6G TiN	Drückfix N TiCN	Drückfix N CrB2		Drückfix N HF TiN		
		6GX	6HX	6GX	6HX	6HX		6HX		
		2-3	2-3	2-3	2-3	2-3		2-3		
		Werkstoffe mit min. 10% Bruchdehnung Materials with elongation of min. 10%								
		<input type="checkbox"/> P <input type="checkbox"/> <input type="checkbox"/> <input type="checkbox"/> N <input type="checkbox"/> <input type="checkbox"/>	<input type="checkbox"/> F <input type="checkbox"/> <input type="checkbox"/> <input type="checkbox"/> N <input type="checkbox"/> <input type="checkbox"/>	<input type="checkbox"/> P <input type="checkbox"/> <input type="checkbox"/> <input type="checkbox"/> N <input type="checkbox"/> <input type="checkbox"/>	<input type="checkbox"/> <input type="checkbox"/> <input type="checkbox"/> M <input type="checkbox"/> <input type="checkbox"/> <input type="checkbox"/> <input type="checkbox"/> <input type="checkbox"/> N <input type="checkbox"/> <input type="checkbox"/>	<input type="checkbox"/> <input type="checkbox"/> <input type="checkbox"/> <input type="checkbox"/> <input type="checkbox"/> <input type="checkbox"/>	<input type="checkbox"/> <input type="checkbox"/> <input type="checkbox"/> <input type="checkbox"/> <input type="checkbox"/> <input type="checkbox"/>	<input type="checkbox"/> P <input type="checkbox"/> <input type="checkbox"/> <input type="checkbox"/> <input type="checkbox"/>	<input type="checkbox"/> <input type="checkbox"/> <input type="checkbox"/> <input type="checkbox"/>	<input type="checkbox"/> <input type="checkbox"/> <input type="checkbox"/> <input type="checkbox"/>
		TiN	TiN	TiN	TiCN	CrB2		TiN		
		Aufmaß Oversize		Aufmaß Oversize						
		T2	T2	T2	T2	T2		T2		
d	P mm	Verfügbarkeit Availability								
M 1	0,25									
M 1,2	0,25									
M 1,4	0,3									
M 1,6	0,35									
M 1,7	0,35									
M 1,8	0,35									
M 2	0,4	x	o	o						
M 2,5	0,45	x	o	o						
M 3	0,5	x	x	x	x	x		x		
M 3,5	0,6	x	x	x						
M 4	0,7	x	x	x	x	x		x		
M 5	0,8	x	x	x	x	x		x		
M 6	1	x	x	x	x	x		x		
M 8	1,25	x	x	x	x	x		x		
M 10	1,5	x	x	x	x	x		x		

x = ab Lager, Zwischenverkauf vorbehalten  
o = nur solange Lagervorrat vorhanden  
x = normally ex stock  
o = available while stocks last



M

**Metrisches ISO-Regelgewinde DIN 13**  
Baumaße DIN 2174 (376), Überlaufschaff  
**ISO Metric Coarse Threads, DIN 13**  
Dimensions DIN 2174 (376), Reduced shank

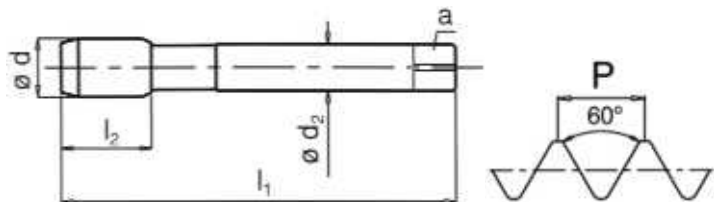

Katalog Nr. Bezeichnung	Catalogue No. Name		110 339 Drückfix	110 341 Drückfix N	110 342 Drückfix N 6G	110 343 Drückfix TiN		
Toleranz	Tolerance		6HX	6HX	6GX	6HX		
Anschnittform	Chamfer form		2-3	2-3	2-3	2-3		
Anschnittlänge, Gang	Chamfer length, threads							
für Bohrungsart	For holes							
Sonderwerkstoff	Special material		Werkstoffe mit min. 10% Bruchdehnung Materials with elongation of min. 10% 1)					
Zerspanungsgruppe, siehe Ausklappseite links	Machinability-group, See folder left page		<input type="checkbox"/> P <input type="checkbox"/> N <input type="checkbox"/>	<input type="checkbox"/> P <input type="checkbox"/> N <input type="checkbox"/>	<input type="checkbox"/> P <input type="checkbox"/> N <input type="checkbox"/>	<input type="checkbox"/> P <input type="checkbox"/> N <input type="checkbox"/>		
Oberfläche	Surface					TiN		
Ausführung	Variation				Aufmaß Oversize			
Typenbeschreibung ab Seite	Type description from page		T2	T2	T2	T2		
d	P	Code	l <sub>1</sub>	l <sub>2</sub>	d <sub>2</sub>	a	Verfügbarkeit Availability	
	mm							
M 12	1,75	12	110	22	9,0	7,0	11,25	
M 14	2	14	110	25	11,0	9,0	13,10	
M 16	2	16	110	25	12,0	9,0	15,10	
M 18	2,5	18	125	30	14,0	11,0	16,90	
M 20	2,5	20	140	32	16,0	12,0	18,90	
M 22	2,5	22	140	27	18,0	14,5	20,90	
M 24	3	24	160	30	18,0	14,5	22,70	
M 27	3	27	160	30	20,0	16,0	25,70	
M 30	3,5	30	180	35	22,0	18,0	28,50	
M 33	3,5	33	180	35	25,0	20,0	31,50	
M 36	4	36	200	40	28,0	22,0	34,30	
M 39	4	39	200	40	32,0	24,0	37,30	

1) nur als Basis für beschichtete Varianten  
only base for coated types

x = ab Lager, Zwischenverkauf vorbehalten  
o = nur solange Lagervorrat vorhanden  
x = normally ex stock  
o = available while stocks last

M

HSS-EP

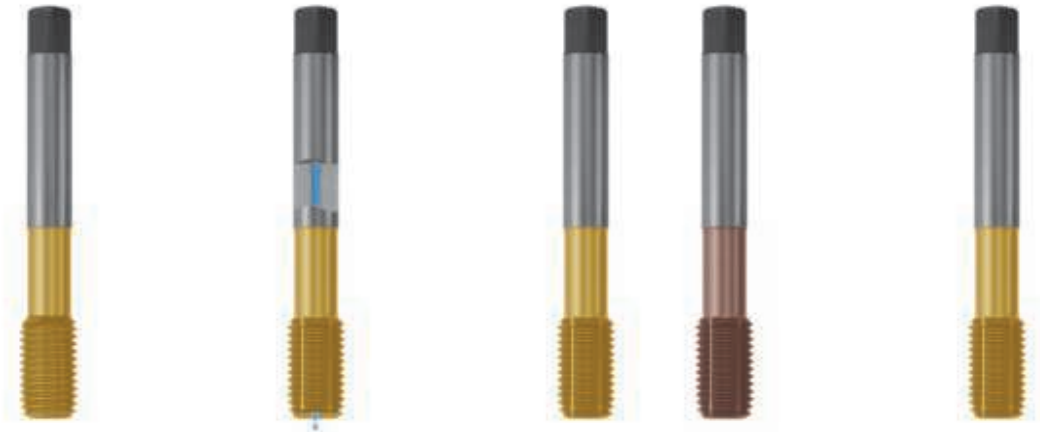

		110 344 Drückfix 6G TiN		110 345 Drückfix N IKZ TiN		110 346 Drückfix N 6G TiN	110 347 Drückfix N TiCN		110 349 Drückfix N HF TiN
		6GX		6HX		6GX	6HX		6HX
		2-3		2-3		2-3	2-3		2-3
Werkstoffe mit min. 10% Bruchdehnung Materials with elongation of min. 10%									
		<input type="checkbox"/> P <input type="checkbox"/> <input type="checkbox"/> <input type="checkbox"/> N <input type="checkbox"/>		<input type="checkbox"/> P <input type="checkbox"/> <input type="checkbox"/> <input type="checkbox"/> N <input type="checkbox"/>		<input type="checkbox"/> P <input type="checkbox"/> <input type="checkbox"/> <input type="checkbox"/> N <input type="checkbox"/> <input type="checkbox"/> M <input type="checkbox"/> <input type="checkbox"/> <input type="checkbox"/>			<input type="checkbox"/> P <input type="checkbox"/> <input type="checkbox"/> <input type="checkbox"/> <input type="checkbox"/>
		TiN		TiN		TiN	TiCN		TiN
		Aufmaß Oversize				Aufmaß Oversize			
		T2		T2		T2	T2		T2
d	P mm					Verfügbarkeit Availability			
M 12	1,75	o		x		x	x		x
M 14	2			x		o			
M 16	2			x		x	x		x
M 18	2,5			x					
M 20	2,5			x			x		x
M 22	2,5			x					
M 24	3			x					
M 27	3			x					
M 30	3,5			x					
M 33	3,5			x					
M 36	4			x					
M 39	4			x					

x = ab Lager, Zwischenverkauf vorbehalten  
o = nur solange Lagervorrat vorhanden  
x = normally ex stock  
o = available while stocks last

EG-M

Metrisches ISO-Regelgewinde für Draht-Gewindeeinsätze DIN 8140/2

Baumaße DIN 40435, verstärkter Schaft

ISO Metric Coarse Threads for wire inserts DIN 8140/2

Dimensions DIN 40435, Reinforced shank

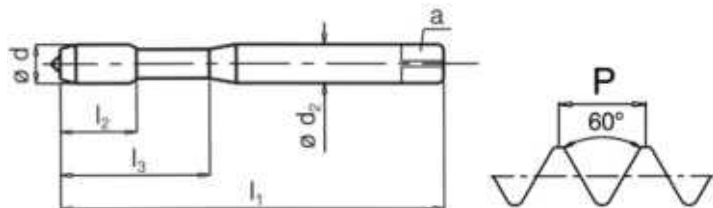

Katalog Nr. Bezeichnung	Catalogue No. Name	133 205 Dulofix	133 226 Spiralo 35	133 252 Spiralo 45															
Toleranz	Tolerance	6H mod B	6H mod C	6H mod C															
Anschnittform	Chamfer form	4-5	2-3	2-3															
Anschnittlänge, Gang für Bohrungsart	Chamfer length, threads For holes																		
Sonderwerkstoff	Special material			Aluminium 3.20 / 4.14															
Zerspanungsgruppe, siehe Ausklappseite links	Machinability-group, See folder left page	<input type="checkbox"/> P <input type="checkbox"/> <input type="checkbox"/> <input checked="" type="checkbox"/> N <input type="checkbox"/>	<input type="checkbox"/> P <input type="checkbox"/> <input type="checkbox"/> <input checked="" type="checkbox"/> N <input type="checkbox"/>	<input type="checkbox"/> <input type="checkbox"/> <input type="checkbox"/> <input checked="" type="checkbox"/> N <input type="checkbox"/>															
Oberfläche	Surface																		
Ausführung	Variation			2 Nuten 2 Flutes															
Typenbeschreibung ab Seite	Type description from page	T2	T2	T2															
d	P	Code	l <sub>1</sub>	l <sub>2</sub>	l <sub>2</sub>	l <sub>3</sub>	d <sub>2</sub>	a		Verfügbarkeit Availability									
	mm				SSP**														
EG M 2,5	0,45	02,5	56	10	6	18	3,5	2,7	2,65	x	x	x							
EG M 3	0,5	03	63	10	6	21	4,5	3,4	3,20	x	x	x							
EG M 3,5	0,6	03,5	63	14	8	22	4,5	3,4	3,70	x	x	x							
EG M 4	0,7	04	70	14	9	25	6,0	4,9	4,20	x	x	x							
EG M 5	0,8	05	80	17	10	30	6,0	4,9	5,25	x	x	x							
EG M 6	1	06	90	18	12	35	8,0	6,2	6,30	x	x	x							
EG M 8	1,25	08	100	20	14	39	10,0	8,0	8,40	x	x	x							

x = ab Lager, Zwischenverkauf vorbehalten  
o = nur solange Lagervorrat vorhanden  
x = normally ex stock  
o = available while stocks last

\*\* SSP = Steilspirale  
\*\* SSP = quick spiral

**EG-M**

Metrisches ISO-Regelgewinde für Draht-Gewindeeinsätze DIN 8140/2

Baumaße DIN 40435 Teil 1 (376), Überlaufschaft

ISO Metric Coarse Threads for wire inserts DIN 8140/2

Dimensions DIN 40435 part 1 (376), Reduced shank

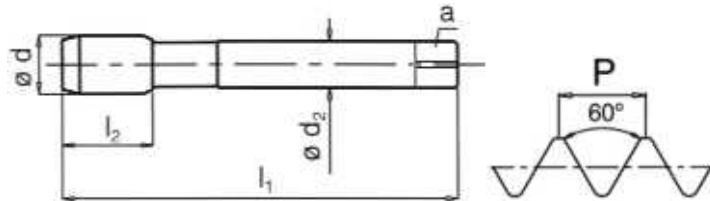

Katalog Nr. Bezeichnung	Catalogue No. Name	133 305 Dulofix	133 326 Spiralo 35	133 352 Spiralo 45					
Toleranz	Tolerance	6H mod	6H mod	6H mod					
Anschnittform	Chamfer form	B	C	C					
Anschnittlänge, Gang	Chamfer length, threads	4-5	2-3	2-3					
für Bohrungsart	For holes								
Sonderwerkstoff	Special material			Aluminium 3.20 / 4.14					
Zerspanungsgruppe, siehe Ausklappseite links	Machinability-group, See folder left page	<input type="checkbox"/> P <input type="checkbox"/> <input type="checkbox"/> <input checked="" type="checkbox"/> N <input type="checkbox"/>	<input type="checkbox"/> P <input type="checkbox"/> <input type="checkbox"/> <input checked="" type="checkbox"/> N <input type="checkbox"/>	<input type="checkbox"/> <input type="checkbox"/> <input type="checkbox"/> <input checked="" type="checkbox"/> N <input type="checkbox"/>					
Oberfläche	Surface								
Ausführung	Variation								
Typenbeschreibung ab Seite	Type description from page	T2	T2	T2					
d	P	Code	l <sub>1</sub>	l <sub>2</sub>	l <sub>2</sub>	d <sub>2</sub>	a		Verfügbarkeit
	mm				SSP**				Availability
EG M 10	1,5	10	100	22	14	9,0	7,0	10,50	x
EG M 12	1,75	12	110	22	20	11,0	9,0	12,50	x
EG M 14	2	14	110	25	20	12,0	9,0	14,50	x
EG M 16	2	16	125	30	25	14,0	11,0	16,50	x
EG M 18	2,5	18	140	32	25	18,0	14,5	18,75	x
EG M 20	2,5	20	160	36	30	18,0	14,5	20,75	x
EG M 22	2,5	22	160	36	30	18,0	14,5	22,75	x
EG M 24	3	24	160	36	30	20,0	16,0	24,75	x

x = ab Lager, Zwischenverkauf vorbehalten  
o = nur solange Lagervorrat vorhanden  
x = normally ex stock  
o = available while stocks last

\*\* SSP = Steilschnecke  
\*\* SSP = quick spiral

MF

Metrisches ISO-Feingewinde DIN 13

Baumaße DIN 2181, Satz à 2 Stück

ISO Metric Fine Threads, DIN 13

Dimensions DIN 2181, Set of 2 pieces

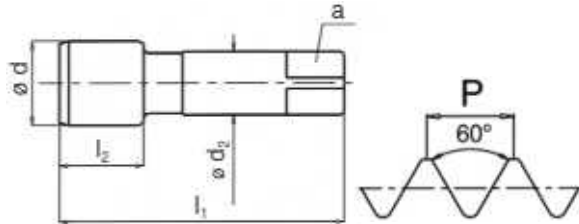

Katalog Nr. Bezeichnung	Catalogue No. Name	111 061 Hahnreiter	111 062 Hahnreiter	111 060 Hahnreiter	111 071 Hahnreiter LH	111072 Hahnreiter LH	111070 Hahnreiter LH
Toleranz	Tolerance	Nr. 1	6H / ISO2	6H / ISO2	Nr. 1	6H / ISO2	6H / ISO2
Anschnittform	Chamfer form	5	C		5	C	
Anschnittlänge, Gang	Chamfer length, threads		2-3			2-3	
für Bohrungsart	For holes						
hauptsächlich Einsatzgebiet	Main use	alle gut spanbaren Materialien bis 800 N/mm <sup>2</sup> all free machining materials up to 800 N/mm <sup>2</sup>					
Zerspanungsgruppe, siehe Ausklappseite links	Machinability-group, See folder left page						
Ausführung	Variation	Vorschneider Taper	Fertigschneider Bottoming	Satz à 2 St. Set of 2 pc.	Vorschneider Links Taper Left hand	Fertigschneider Links Bottoming Left hand	Satz à 2 St. Links Set of 2 pc. Left hand
Oberfläche	Surface	Verfügbarkeit Availability					
d	P mm	Code	l <sub>1</sub>	l <sub>2</sub>	d <sub>2</sub>	a	
M 2	x 0,25	02025	36	8	2,8	2,1	1,75
M 2,2	x 0,25	022025	36	9	2,8	2,1	1,95
M 2,5	x 0,35	025035	40	9	2,8	2,1	2,15
M 3	x 0,35	03035	40	8	3,5	2,1	2,65
M 3,5	x 0,35	035035	45	9	4,0	2,1	3,15
M 4	x 0,35	04035	45	7	4,5	3,4	3,65
M 4	x 0,5	0405	45	7	4,5	3,4	3,50
M 5	x 0,5	0505	50	9	6,0	4,9	4,50
M 6	x 0,5	0605	56	10	6,0	4,9	5,50
M 6	x 0,75	06075	56	10	6,0	4,9	5,20
M 7	x 0,75	07075	56	12	6,0	4,9	6,20
M 8	x 0,5	0805	56	13	6,0	4,9	7,50
M 8	x 0,75	08075	56	13	6,0	4,9	7,20
M 8	x 1	081	63	20	6,0	4,9	7,00
M 9	x 0,75	09075	63	17	7,0	5,5	8,20
M 9	x 1	091	63	17	7,0	5,5	8,00
M 10	x 0,5	1005	63	10	7,0	5,5	9,50
M 10	x 0,75	10075	63	16	7,0	5,5	9,20
M 10	x 1	101	63	16	7,0	5,5	9,00
M 10	x 1,25	10125	70	22	7,0	5,5	8,80
M 12	x 0,75	12075	70	16	9,0	7,0	11,20
M 12	x 1	121	70	16	9,0	7,0	11,00
M 12	x 1,25	12125	70	22	9,0	7,0	10,80
M 12	x 1,5	1215	70	22	9,0	7,0	10,50
M 13	x 1	131	70	20	11,0	9,0	12,00
M 14	x 1	141	70	20	11,0	9,0	13,00
M 14	x 1,25	14125	70	20	11,0	9,0	12,80
M 14	x 1,5	1415	70	20	11,0	9,0	12,50
M 15	x 1	151	70	22	12,0	9,0	14,00
M 15	x 1,5	1515	70	22	12,0	9,0	13,50
M 16	x 1	161	70	22	12,0	9,0	15,00
M 16	x 1,5	1615	70	22	12,0	9,0	14,50

Fortsetzung nächste Seite  
Continued on next page

x = ab Lager, Zwischenverkauf vorbehalten  
o = nur solange Lagervorrat vorhanden  
x = normally ex stock  
o = available while stocks last

MF

Metrisches ISO-Feingewinde DIN 13

Baumaße DIN 2181, Satz à 2 Stück

ISO Metric Fine Threads, DIN 13

Dimensions DIN 2181, Set of 2 pieces

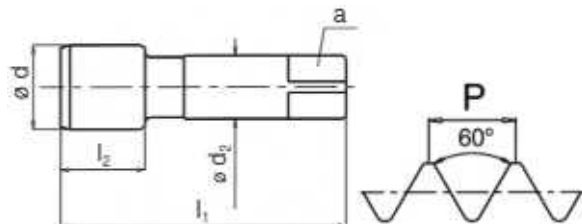

Katalog Nr. Bezeichnung	Catalogue No. Name	111 061 Hahnreiter	111 062 Hahnreiter	111 060 Hahnreiter	111 071 Hahnreiter LH	111072 Hahnreiter LH	111070 Hahnreiter LH
Toleranz	Tolerance	Nr. 1	6H / ISO2	6H / ISO2	Nr. 1	6H / ISO2	6H / ISO2
Anschnittform	Chamfer form	5	C		5	C	
Anschnittlänge, Gang	Chamfer length, threads		2-3			2-3	
für Bohrungsart	For holes						
hauptsächlich Einsatzgebiet	Main use	alle gut spanbaren Materialien bis 800 N/mm <sup>2</sup> all free machining materials up to 800 N/mm <sup>2</sup>					
Zerspanungsgruppe, siehe Ausklappseite links	Machinability-group, See folder left page						
Ausführung	Variation	Vorschneider Taper	Fertigschneider Bottoming	Satz à 2 St. Set of 2 pc.	Vorschneider Links Taper Left hand	Fertigschneider Links Bottoming Left hand	Satz à 2 St. Links Set of 2 pc. Left hand
Oberfläche	Surface	Verfügbarkeit Availability					
d	P mm	Code	l <sub>1</sub>	l <sub>2</sub>	d <sub>2</sub>	a	
M 18	x 1	181	80	22	14,0	11,0	17,00
M 18	x 1,5	1815	80	22	14,0	11,0	16,50
M 18	x 2	182	80	22	14,0	11,0	16,00
M 20	x 1	201	80	22	16,0	12,0	19,00
M 20	x 1,5	2015	80	22	16,0	12,0	18,50
M 20	x 2	202	80	22	16,0	12,0	18,00
M 22	x 1	221	80	22	18,0	14,5	21,00
M 22	x 1,5	2215	80	22	18,0	14,5	20,50
M 22	x 2	222	80	22	18,0	14,5	20,00
M 24	x 1	241	90	22	18,0	14,5	23,00
M 24	x 1,5	2415	90	22	18,0	14,5	22,50
M 24	x 2	242	90	22	18,0	14,5	22,00
M 25	x 1	251	90	22	18,0	14,5	24,00
M 25	x 1,5	2515	90	22	18,0	14,5	23,50
M 26	x 1,5	2615	90	22	18,0	14,5	24,50
M 27	x 1,5	2715	90	22	20,0	16,0	25,50
M 27	x 2	272	90	22	20,0	16,0	25,00
M 28	x 1,5	2815	90	22	20,0	16,0	26,50
M 28	x 2	282	90	22	20,0	16,0	26,00
M 30	x 1	301	90	22	22,0	18,0	29,00
M 30	x 1,5	3015	90	22	22,0	18,0	28,50
M 30	x 2	302	90	22	22,0	18,0	28,00
M 32	x 1,5	3215	90	22	22,0	18,0	30,50
M 33	x 1,5	3315	100	25	25,0	20,0	31,50
M 33	x 2	332	100	25	25,0	20,0	31,00
M 34	x 1,5	3415	100	25	28,0	22,0	32,50
M 35	x 1,5	3515	100	25	28,0	22,0	33,50
M 36	x 1,5	3615	100	25	28,0	22,0	34,50
M 36	x 2	362	125	30	28,0	22,0	34,00
M 36	x 3	363	125	36	28,0	22,0	33,00
M 38	x 1,5	3815	100	25	28,0	22,0	36,50
M 39	x 2	392	125	30	32,0	24,0	37,00
M 39	x 3	393	125	36	32,0	24,0	36,00

Fortsetzung nächste Seite  
Continued on next page

x = ab Lager, Zwischenverkauf vorbehalten  
o = nur solange Lagervorrat vorhanden  
x = normally ex stock  
o = available while stocks last



MF

Metrisches ISO-Feingewinde DIN 13

Baumaße DIN 2181, Satz à 2 Stück

ISO Metric Fine Threads, DIN 13

Dimensions DIN 2181, Set of 2 pieces

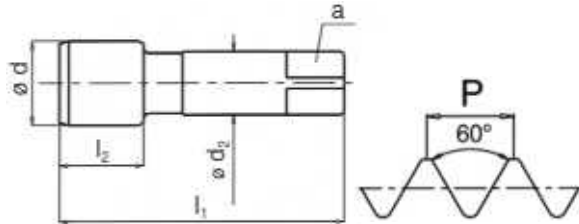

Katalog Nr. Bezeichnung	Catalogue No. Name	111 061 Hahnreiter	111 062 Hahnreiter	111 060 Hahnreiter						
Toleranz	Tolerance	Nr. 1	6H / ISO2	6H / ISO2						
Anschnittform	Chamfer form	5	C							
Anschnittlänge, Gang	Chamfer length, threads		2-3							
für Bohrungsart	For holes									
hauptsächlich Einsatzgebiet	Main use	alle gut spanbaren Materialien bis 800 N/mm <sup>2</sup> all free machining materials up to 800 N/mm <sup>2</sup>								
Zerspanungsgruppe, siehe Ausklappseite links	Machinability-group, See folder left page	<input type="checkbox"/> P <input type="checkbox"/> K <input type="checkbox"/> N	<input type="checkbox"/> P <input type="checkbox"/> K <input type="checkbox"/> N	<input type="checkbox"/> P <input type="checkbox"/> K <input type="checkbox"/> N						
Ausführung	Variation	Vorschneider Taper	Fertigschneider Bottoming	Satz à 2 St. Set of 2 pc.						
Oberfläche	Surface									
d	P mm	Code	l <sub>1</sub>	l <sub>2</sub>	d <sub>2</sub>	a		Verfügbarkeit Availability		
M 40 x 1,5	4015	110	25	32,0	24,0	38,50		x	x	x
M 40 x 2	402	125	30	32,0	24,0	38,00		x	x	x
M 40 x 3	403	125	36	32,0	24,0	37,00		x	x	x
M 42 x 1,5	4215	110	25	32,0	24,0	40,50		x	x	x
M 42 x 2	422	125	30	32,0	24,0	40,00		x	x	x
M 42 x 3	423	125	36	32,0	24,0	39,00		x	x	x
M 45 x 1,5	4515	110	25	36,0	29,0	43,50		x	x	x
M 45 x 2	452	125	30	36,0	29,0	43,00		x	x	x
M 45 x 3	453	125	36	36,0	29,0	42,00		x	x	x
M 48 x 1,5	4815	140	25	36,0	29,0	46,50		x	x	x
M 48 x 2	482	140	30	36,0	29,0	46,00		x	x	x
M 48 x 3	483	140	36	36,0	29,0	45,00		x	x	x
M 50 x 1,5	5015	140	25	36,0	29,0	48,50		x	x	x
M 50 x 2	502	140	30	36,0	29,0	48,00		x	x	x
M 50 x 3	503	140	36	36,0	29,0	47,00		x	x	x
M 52 x 1,5	5215	140	25	40,0	32,0	50,50		x	x	x
M 52 x 2	522	140	30	40,0	32,0	50,00		x	x	x
M 52 x 3	523	140	36	40,0	32,0	49,00		x	x	x
M 54 x 1,5	5415	140	32	40,0	32,0	52,50		x	x	x
M 56 x 1,5	5615	140	32	40,0	32,0	54,50		x	x	x
M 56 x 2	562	140	32	40,0	32,0	54,00		x	x	x
M 58 x 1,5	5815	160	32	45,0	35,0	56,50		x	x	x
M 60 x 2	602	160	32	45,0	35,0	58,00		x	x	x
M 60 x 3	603	160	36	45,0	35,0	57,00		x	x	x
M 62 x 1,5	6215	160	32	50,0	35,0	60,50		x	x	x
M 63 x 1,5	6315	160	32	50,0	39,0	61,50		x	x	x
M 64 x 2	642	160	32	50,0	39,0	62,00		x	x	x
M 64 x 4	644	220	45	50,0	39,0	60,00		x	x	x

Größere Ø auf Anfrage.  
Bigger Ø on request.

x = ab Lager, Zwischenverkauf vorbehalten  
o = nur solange Lagervorrat vorhanden  
x = normally ex stock  
o = available while stocks last

MF

Metrisches ISO-Feingewinde DIN 13

Baumaße DIN 2181, Satz à 2 Stück

ISO Metric Fine Threads, DIN 13

Dimensions DIN 2181, Set of 2 pieces

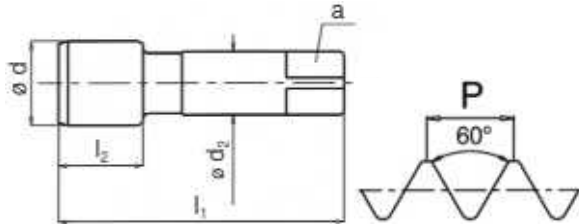

MF

Katalog Nr. Bezeichnung	Catalogue No. Name	111 081 Nirofix Nr. 1	111 082 Nirofix 6H / ISO2 C 2-3	111 080 Nirofix 6H / ISO2						
Toleranz	Tolerance									
Anschnittform	Chamfer form									
Anschnittlänge, Gang	Chamfer length, threads	5								
für Bohrungsart	For holes									
hauptsächlich Einsatzgebiet	Main use	für rostfreie Stähle und Stähle > 1000 N/mm <sup>2</sup> for stainless steel and steel > 1000 N/mm <sup>2</sup>								
Zerspanungsgruppe, siehe Ausklappseite links	Machinability-group, See folder left page	<input type="checkbox"/> M <input type="checkbox"/> S	<input type="checkbox"/> M <input type="checkbox"/> S	<input type="checkbox"/> M <input type="checkbox"/> S						
Ausführung	Variation	Vorschneider Taper	Fertigschneider Bottoming	Satz à 2 St. Set of 2 pc.						
Oberfläche	Surface	VAP	VAP	VAP						
d	P mm	Code	l <sub>1</sub>	l <sub>2</sub>	d <sub>2</sub>	a		Verfügbarkeit Availability		
M 4	x 0,5	0405	45	7	4,5	3,4	3,50	x	x	x
M 5	x 0,5	0505	50	9	6,0	4,9	4,50	x	x	x
M 6	x 0,5	0605	56	10	6,0	4,9	5,50	x	x	x
M 6	x 0,75	06075	56	10	6,0	4,9	5,20	x	x	x
M 8	x 0,75	08075	56	13	6,0	4,9	7,20	x	x	x
M 8	x 1	081	63	20	6,0	4,9	7,00	x	x	x
M 10	x 1	101	63	16	7,0	5,5	9,00	x	x	x
M 10	x 1,25	10125	70	22	7,0	5,5	8,80	x	x	x
M 12	x 1	121	70	16	9,0	7,0	11,00	x	x	x
M 12	x 1,25	12125	70	22	9,0	7,0	10,80	x	x	x
M 12	x 1,5	1215	70	22	9,0	7,0	10,50	x	x	x
M 14	x 1	141	70	20	11,0	9,0	13,00	x	x	x
M 14	x 1,25	14125	70	20	11,0	9,0	12,80	x	x	x
M 14	x 1,5	1415	70	20	11,0	9,0	12,50	x	x	x
M 16	x 1,5	1615	70	22	12,0	9,0	14,50	x	x	x
M 18	x 1,5	1815	80	22	14,0	11,0	16,50	x	x	x
M 20	x 1,5	2015	80	22	16,0	12,0	18,50	x	x	x
M 22	x 1,5	2215	80	22	18,0	14,5	20,50	x	x	x
M 24	x 1,5	2415	90	22	18,0	14,5	22,50	x	x	x

x = ab Lager, Zwischenverkauf vorbehalten  
o = nur solange Lagervorrat vorhanden  
x = normally ex stock  
o = available while stocks last

MF

Gewinde für Elektroinstallationsrohre DIN EN 60423

Baumaße DIN 2181, Satz à 2 Stück

Threads for conduits and fittings, DIN EN 60423

Dimensions DIN 2181, Set of 2 pieces

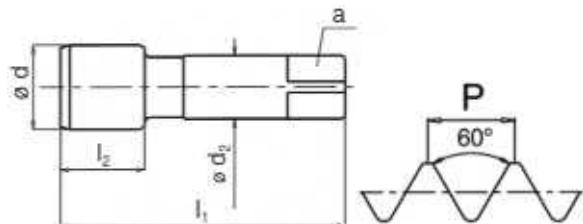

Katalog Nr. Bezeichnung	Catalogue No. Name		111 061 Hahnreiter	111 092 Hahnreiter		111 090 Hahnreiter							
Toleranz	Tolerance		Nr. 1	6G/7H		6G/7H							
Anschnittform	Chamfer form		5	C									
Anschnittlänge, Gang	Chamfer length, threads			2-3									
für Bohrungsart	For holes												
hauptsächlich Einsatzgebiet	Main use	alle gut spanbaren Materialien bis 800 N/mm <sup>2</sup> all free machining materials up to 800 N/mm <sup>2</sup>											
Zerspanungsgruppe, siehe Ausklappseite links	Machinability-group, See folder left page												
Ausführung	Variation		Vorschneider Taper	Fertigschneider Bottoming		Satz à 2 St. Set of 2 pc.							
Oberfläche	Surface												
d	P mm	Code	$l_1$	$l_2$	$d_2$	$a$		Verfügbarkeit Availability					
M 8	x 1	081	63	20	6,0	4,9	7,00		x	x			x
M 10	x 1	101	63	16	7,0	5,5	9,00		x	x			x
M 12	x 1,5	1215	70	22	9,0	7,0	10,50		x	x			x
M 16	x 1,5	1615	70	22	12,0	9,0	14,50		x	x			x
M 20	x 1,5	2015	80	22	16,0	12,0	18,50		x	x			x
M 25	x 1,5	2515	90	22	18,0	14,5	23,50		x	x			x
M 32	x 1,5	3215	90	22	22,0	18,0	30,50		x	x			x
M 40	x 1,5	4015	110	25	32,0	24,0	38,50		x	x			x
M 50	x 1,5	5015	140	25	36,0	29,0	48,50		x	x			x
M 63	x 1,5	6315	160	35	45,0	35,0	61,50		x	x			x

x = ab Lager, Zwischenverkauf vorbehalten  
o = nur solange Lagervorrat vorhanden  
x = normally ex stock  
o = available while stocks last

MF

Metrisches ISO-Feingewinde DIN 13

Baumaße Werksnorm

ISO Metric Fine Threads, DIN 13

Dimensions manufacturer's standard

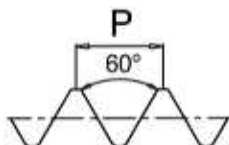
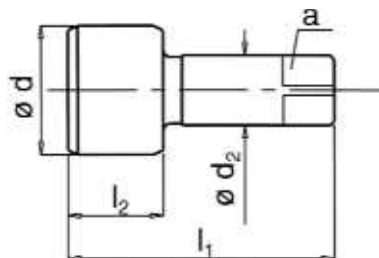

MF

Katalog Nr. Bezeichnung	Catalogue No. Name	111 600 Automat MS	111 601 Automat MS 6G	111 602 Automat MS +0,1	111 605 Automat 15	111 606 Automat 15 6G							
Toleranz	Tolerance	6H / ISO2	6G / ISO3	6H +0,1	6H / ISO2	6G / ISO3							
Anschnittform	Chamfer form	E	E	E	E	E							
Anschnittlänge, Gang	Chamfer length, threads	1,5-2	1,5-2	1,5-2	1,5-2	1,5-2							
für Bohrungsart	For holes												
Sonderwerkstoff	Special material	Messing Brass 3.21			Automatenstahl free cutting steel 1.2								
Zerspanungsgruppe, siehe Ausklappseite links	Machinability-group, See folder left page	<input type="checkbox"/>	<input type="checkbox"/>	<input type="checkbox"/>	<input checked="" type="checkbox"/>	<input checked="" type="checkbox"/>							
Oberfläche	Surface				VAP	VAP							
Ausführung	Variation		Aufmaß Oversize	Aufmaß Oversize		Aufmaß Oversize							
Typenbeschreibung ab Seite	Type description from page	T2	T2	T2	T2	T2							
d	P	Code	l <sub>1</sub>	l <sub>2</sub>	d <sub>2</sub>	a	Verfügbarkeit Availability						
mm													
M 8	x	1	081	70	17	6,0	4,9	7,00	x	x	x	x	x
M 10	x	1	101	70	22	8,0	6,2	9,00	x	x	x	x	x
M 10	x	1,25	10125	70	22	8,0	6,2	8,80	x	x	x	x	x
M 11	x	1	111	70	18	9,0	7,0	10,00	x	x	x	x	x
M 12	x	1	121	70	18	9,0	7,0	11,00	x	x	x	x	x
M 12	x	1,25	12125	70	18	9,0	7,0	10,80	x	x	x	x	x
M 12	x	1,5	1215	70	22	9,0	7,0	10,50	x	x	x	x	x
M 13	x	1	131	70	20	10,0	8,0	12,00	x	x	x	x	x
M 14	x	1	141	70	20	10,0	8,0	13,00	x	x	x	x	x
M 14	x	1,25	14125	70	20	10,0	8,0	12,80	x	x	x	x	x
M 14	x	1,5	1415	70	20	10,0	8,0	12,50	x	x	x	x	x
M 16	x	1,5	1615	70	20	12,0	9,0	14,50	x	x	x	x	x
M 18	x	1,5	1815	70	22	12,0	9,0	16,50	x	x	x	x	x
M 20	x	1,5	2015	70	22	15,0	12,0	18,50	x	x	x	x	x
M 22	x	1,5	2215	70	22	15,0	12,0	20,50	x	x	x	x	x
M 24	x	1,5	2415	70	22	18,0	14,5	22,50	x	x	x	x	x
M 26	x	1,5	2615	70	24	18,0	14,5	24,50	x	x	x	x	x
M 28	x	1,5	2815	70	24	18,0	14,5	26,50	x	x	x	x	x
M 30	x	1,5	3015	70	24	18,0	14,5	28,50	x	x	x	x	x
Weitere Abmessungen und Aufmaße ab Lager verfügbar. Bitte anfragen. Other sizes and oversizes ex stock available on request.													

x = ab Lager, Zwischenverkauf vorbehalten  
o = nur solange Lagervorrat vorhanden  
x = normally ex stock  
o = available while stocks last

MF

Metrisches ISO-Feingewinde DIN 13

Baumaße Werksnorm

ISO Metric Fine Threads, DIN 13

Dimensions manufacturer's standard

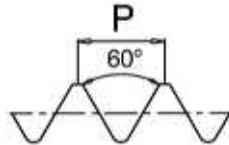
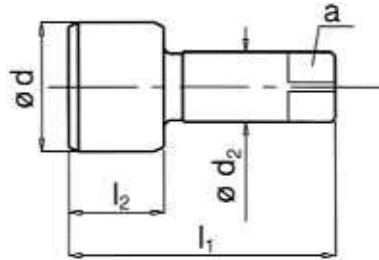

Katalog Nr. Bezeichnung	Catalogue No. Name	111 619 Automat 20 MS-Z	111 611 Automat 20 6G MS-Z	111 612 Automat 20+0,1 MS-Z					
Toleranz	Tolerance	6HX	6GX	6H +0,1					
Anschnittform	Chamfer form	E	E	E					
Anschnittlänge, Gang	Chamfer length, threads	1,5-2	1,5-2	1,5-2					
für Bohrungsart	For holes								
Sonderwerkstoff	Special material	Messing, bleifrei, bleireduziert Brass, leadfree, reduced lead 3.22							
Zerspanungsgruppe, siehe Ausklappseite links	Machinability-group, See folder left page	<input type="checkbox"/>	<input type="checkbox"/>	<input type="checkbox"/>	<input type="checkbox"/>	<input type="checkbox"/>			
Oberfläche	Surface								
Ausführung	Variation		Aufmaß Oversize	Aufmaß Oversize					
Typenbeschreibung ab Seite	Type description from page	T2	T2	T2					
d	P	Code	l <sub>1</sub>	l <sub>2</sub>	d <sub>2</sub>	a	Verfügbarkeit Availability		
	mm								
M 8	x 1	081	70	17	6,0	4,9 7,00	x	x	x
M 10	x 1	101	70	22	8,0	6,2 9,00	x	x	x
M 10	x 1,25	10125	70	22	8,0	6,2 8,80			
M 11	x 1	111	70	18	9,0	7,0 10,00			
M 12	x 1	121	70	18	9,0	7,0 11,00	x	x	x
M 12	x 1,25	12125	70	18	9,0	7,0 10,80			
M 12	x 1,5	1215	70	22	9,0	7,0 10,50	x	x	x
M 13	x 1	131	70	20	10,0	8,0 12,00			
M 14	x 1	141	70	20	10,0	8,0 13,00	x	x	x
M 14	x 1,25	14125	70	20	10,0	8,0 12,80	x	x	x
M 14	x 1,5	1415	70	20	10,0	8,0 12,50	x	x	x
M 16	x 1,5	1615	70	20	12,0	9,0 14,50	x	x	x
M 18	x 1,5	1815	70	22	12,0	9,0 16,50			
M 20	x 1,5	2015	70	22	16,0 (15,0)*	12,0 18,50			
M 22	x 1,5	2215	70	22	16,0 (15,0)*	12,0 20,50			
M 24	x 1,5	2415	70	22	18,0	14,5 22,50			
M 26	x 1,5	2615	70	24	18,0	14,5 24,50			
M 28	x 1,5	2815	70	24	18,0	14,5 26,50			
M 30	x 1,5	3015	70	24	18,0	14,5 28,50			

\*solange Lagervorrat liefern wir mit Schaft Ø 15,0  
\*as long as available we will send shank Ø 15,0

x = ab Lager, Zwischenverkauf vorbehalten  
o = nur solange Lagervorrat vorhanden  
x = normally ex stock  
o = available while stocks last

MF



		111 616 Automat 20 Sty	111 617 Automat 20 6G Sty	111 618 Automat 20+0,1 Sty	111 607 Automat 20	111 608 Automat 20 6G	111 609 Automat 20+0,1	111 613 Automat 20 TiN	111 614 Automat 20 6G TiN	111 615 Automat 20+0,1 TiN
		6HX E 1,5-2	6GX E 1,5-2	6H +0,1 E 1,5-2	6HX E 1,5-2	6GX E 1,5-2	6H +0,1 E 1,5-2	6HX E 1,5-2	6GX E 1,5-2	6H + 0,1 E 1,5-2
Cu-Sonderlegierungen bleifrei, bleireduziert <i>Special copper alloys, leadfree, low-leaded</i> 3.22				Automatenstahl <i>free cutting steel</i> 1.2			rostfreie Stähle <i>stainless steels</i> 1.9.4. / 1.9.5.			
		<input type="checkbox"/> <input type="checkbox"/> <input type="checkbox"/> <input checked="" type="checkbox"/> <input type="checkbox"/>	<input type="checkbox"/> <input type="checkbox"/> <input type="checkbox"/> <input checked="" type="checkbox"/> <input type="checkbox"/>	<input type="checkbox"/> <input type="checkbox"/> <input type="checkbox"/> <input checked="" type="checkbox"/> <input type="checkbox"/>	<input checked="" type="checkbox"/> <input type="checkbox"/> <input type="checkbox"/> <input type="checkbox"/> <input type="checkbox"/> <input type="checkbox"/>	<input checked="" type="checkbox"/> <input type="checkbox"/> <input type="checkbox"/> <input type="checkbox"/> <input type="checkbox"/> <input type="checkbox"/>	<input checked="" type="checkbox"/> <input type="checkbox"/> <input type="checkbox"/> <input type="checkbox"/> <input type="checkbox"/> <input type="checkbox"/>	<input checked="" type="checkbox"/> <input type="checkbox"/> <input type="checkbox"/> <input type="checkbox"/> <input type="checkbox"/> <input type="checkbox"/>	<input checked="" type="checkbox"/> <input type="checkbox"/> <input type="checkbox"/> <input type="checkbox"/> <input type="checkbox"/> <input type="checkbox"/>	<input checked="" type="checkbox"/> <input type="checkbox"/> <input type="checkbox"/> <input type="checkbox"/> <input type="checkbox"/> <input type="checkbox"/>
		Stygian	Stygian	Stygian	VAP	VAP	VAP	TiN	TiN	TiN
		T2	Aufmaß Oversize	Aufmaß Oversize	T2	Aufmaß Oversize	Aufmaß Oversize	T2	Aufmaß Oversize	Aufmaß Oversize
d	P mm	T2	T2	T2	T2	T2	T2	T2	T2	T2
		Verfügbarkeit <i>Availability</i>								
M 8	x 1	x	x	x	x	x	x	x	x	x
M 10	x 1	x	x	x	x	x	x	x	x	x
M 10	x 1,25									
M 11	x 1									
M 12	x 1	x	x	x	x	x	x	x	x	x
M 12	x 1,25									
M 12	x 1,5	x	x	x	x	x	x	x	x	x
M 13	x 1									
M 14	x 1	x	x	x	x	x	x	x	x	x
M 14	x 1,25	x	x	x	x	x	x	x	x	x
M 14	x 1,5	x	x	x	x	x	x	x	x	x
M 16	x 1,5	x	x	x	x	x	x	x	x	x
M 18	x 1,5									
M 20	x 1,5									
M 22	x 1,5									
M 24	x 1,5									
M 26	x 1,5									
M 28	x 1,5				o	o				
M 30	x 1,5									

x = ab Lager, Zwischenverkauf vorbehalten  
o = nur solange Lagervorrat vorhanden  
x = normally ex stock  
o = available while stocks last



MF

Metrisches ISO-Feingewinde DIN 13

Baumaße DIN 2184 Teil 1 (DIN 371), verstärkter Schaft

ISO Metric Fine Threads, DIN 13

Dimensions DIN 2184 part 1 (DIN 371), Reinforced shank

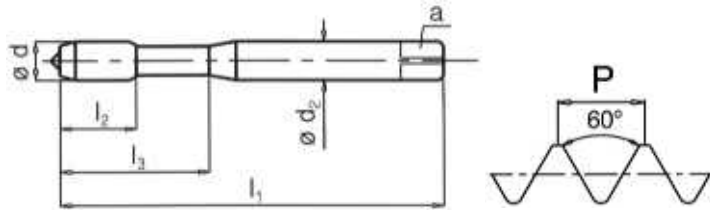

Katalog Nr. Bezeichnung	Catalogue No. Name	111 200 Hahnreiter	111 205 Dulofix	111 210 Dulofix TiN	111 218 Spiralo 15	111 226 Spiralo 35										
Toleranz	Tolerance	6H / ISO2	6H / ISO2	6H / ISO2	6H / ISO2	6H / ISO2										
Anschnittform	Chamfer form	C	B	B	C	C										
Anschnittlänge, Gang	Chamfer length, threads	2-3	4-5	4-5	2-3	2-3										
für Bohrungsart	For holes															
Sonderwerkstoff	Special material															
Zerspanungsgruppe, siehe Ausklappseite links	Machinability-group, See folder left page	<input type="checkbox"/> P <input type="checkbox"/> <input type="checkbox"/> <input type="checkbox"/> <input type="checkbox"/>	<input type="checkbox"/> P <input type="checkbox"/> <input type="checkbox"/> <input checked="" type="checkbox"/> N <input type="checkbox"/>	<input type="checkbox"/> P <input type="checkbox"/> <input type="checkbox"/> <input checked="" type="checkbox"/> N <input type="checkbox"/>	<input type="checkbox"/> P <input type="checkbox"/> <input type="checkbox"/> <input checked="" type="checkbox"/> N <input type="checkbox"/>	<input type="checkbox"/> P <input type="checkbox"/> <input type="checkbox"/> <input checked="" type="checkbox"/> N <input type="checkbox"/>										
Oberfläche	Surface			TiN												
Ausführung	Variation															
Typenbeschreibung ab Seite	Type description from page	T2	T2	T2	T2	T2										
d	P	Code	l <sub>1</sub>	l <sub>2</sub>	l <sub>2</sub>	l <sub>3</sub>	d <sub>2</sub>	a	Verfügbarkeit Availability							
	mm				SSP**											
M 2	x	0,25	02025	45	6		2,8	2,1	1,75	x	x					
M 2,5	x	0,35	025035	50	9		2,8	2,1	2,15	x	x					
M 3	x	0,35	03035	56	6	18	3,5	2,7	2,65	x	x	x				x
M 4	x	0,5	0405	63	7	23	4,5	3,4	3,50	x	x	x	x			x
M 5	x	0,5	0505	70	9	25	6,0	4,9	4,50	x	x	x	x			x
M 6	x	0,5	0605	80	10	30	6,0	4,9	5,50	x	x	x	x			x
M 6	x	0,75	06075	80	17	10	30	6,0	4,9	5,20	x	x	x			x
M 7	x	0,75	07075	80	17	10	30	7,0	5,5	6,20	x	x				
M 8	x	0,5	0805	90	12	35	8,0	6,2	7,50	o						
M 8	x	0,75	08075	90	12	35	8,0	6,2	7,20	o	o					
M 8	x	1	081	90	18	12	35	8,0	6,2	7,00	x	x	x			x
M 9	x	1	091	90	18	35	9,0	7,0	8,00	o						
M 10	x	0,75	10075	100	14	39	10,0	8,0	9,20	o	o					
M 10	x	1	101	100	20	14	39	10,0	8,0	9,00	x	x	x			x
M 10	x	1,25	10125	100	20	39	10,0	8,0	8,80	o	x					



x = ab Lager, Zwischenverkauf vorbehalten  
o = nur solange Lagervorrat vorhanden  
x = normally ex stock  
o = available while stocks last

\*\* SSP = Steilschnecke  
\*\* SSP = quick spiral

MF



MF

		111 235							
		Spiralo 35 TiN							
		6H / ISO2 C 2-3							
									
									
		TiN							
		T2							
d	P mm	Verfügbarkeit Availability							
M 2	x 0,25								
M 2,5	x 0,35								
M 3	x 0,35	x							
M 4	x 0,5	x							
M 5	x 0,5	x							
M 6	x 0,5	x							
M 6	x 0,75	x							
M 7	x 0,75								
M 8	x 0,5								
M 8	x 0,75								
M 8	x 1	x							
M 9	x 1								
M 10	x 0,75								
M 10	x 1	x							
M 10	x 1,25								

x = ab Lager, Zwischenverkauf vorbehalten  
o = nur solange Lagervorrat vorhanden  
x = normally ex stock  
o = available while stocks last

MF

Metrisches ISO-Feingewinde DIN 13  
Baumaße DIN 374, Überlaufschaft  
ISO Metric Fine Threads, DIN 13  
Dimensions DIN 374, Reduced shank

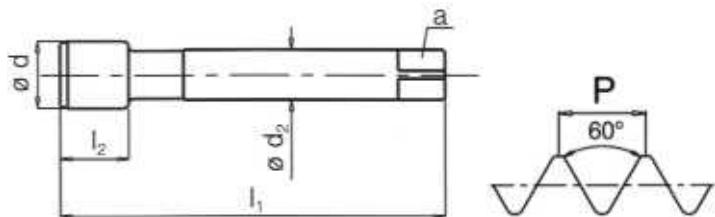

Katalog Nr. Bezeichnung	Catalogue No. Name	111 300 Hahnreiter	111 304 Hahnreiter LH	111 305 Dulofix	111 310 Dulofix TiN	111 307 Dulofix 6G		
Toleranz	Tolerance	6H / ISO2	6H / ISO2	6H / ISO2	6H / ISO2	6G / ISO3		
Anschnittform	Chamfer form	C	C	B	B	B		
Anschnittlänge, Gang	Chamfer length, threads	2-3	2-3	4-5	4-5	4-5		
für Bohrungsart	For holes							
Sonderwerkstoff	Special material							
Zerspanungsgruppe, siehe Ausklappseite links	Machinability-group, See folder left page	<input type="checkbox"/>	<input type="checkbox"/>	<input type="checkbox"/>	<input type="checkbox"/>	<input type="checkbox"/>		
Oberfläche	Surface			TiN				
Ausführung	Variation		Links Left hand			Aufmaß Oversize		
Typenbeschreibung ab Seite	Type description from page	T2	T2	T2	T2	T2		
d	P	Code	l <sub>1</sub>	l <sub>2</sub>	l <sub>2</sub>	d <sub>2</sub>	a	Verfügbarkeit Availability
mm	mm				SSP**			
M 6	x	0605	80	10		4,5	3,4	5,50
M 6	x	06075	80	17	10	4,5	3,4	5,20
M 7	x	07075	80	17		5,5	4,3	6,20
M 8	x	0805	80	13		6,0	4,9	7,50
M 8	x	08075	80	17	13	6,0	4,9	7,20
M 8	x	081	90	17	13	6,0	4,9	7,00
M 9	x	091	90	17		7,0	5,5	8,00
M 10	x	10075	90	17	12	7,0	5,5	9,20
M 10	x	101	90	17	12	7,0	5,5	9,00
M 10	x	10125	100	20	14	7,0	5,5	8,80
M 11	x	111	90	15		8,0	6,2	10,00
M 12	x	121	100	18	14	9,0	7,0	11,00
M 12	x	12125	100	18	14	9,0	7,0	10,80
M 12	x	1215	100	22	14	9,0	7,0	10,50
M 13	x	131	100	20		11,0	9,0	12,00
M 14	x	141	100	22	16	11,0	9,0	13,00
M 14	x	14125	100	22	16	11,0	9,0	12,80
M 14	x	1415	100	22	16	11,0	9,0	12,50
M 15	x	151	100	22		12,0	9,0	14,00
M 15	x	1515	100	22		12,0	9,0	13,50
M 16	x	161	100	22	16	12,0	9,0	15,00
M 16	x	1615	100	22	16	12,0	9,0	14,50
M 18	x	181	110	25		14,0	11,0	17,00
M 18	x	1815	110	25	18	14,0	11,0	16,50
M 18	x	182	125	32	25	14,0	11,0	16,00
M 20	x	201	125	25	18	16,0	12,0	19,00
M 20	x	2015	125	25	18	16,0	12,0	18,50
M 20	x	202	140	32	25	16,0	12,0	18,00
M 22	x	221	125	25	18	18,0	14,5	21,00
M 22	x	2215	125	25	18	18,0	14,5	20,50
M 22	x	222	140	32	25	18,0	14,5	20,00
M 24	x	241	140	25	18	18,0	14,5	23,00
M 24	x	2415	140	25	18	18,0	14,5	22,50
M 24	x	242	140	28	25	18,0	14,5	22,00
M 25	x	2515	140	25	18	18,0	14,5	23,50

ab M26 x 1,5 Fortsetzung Seite: / continued on page:

G62 /./ G62 G62 /./

x = ab Lager, Zwischenverkauf vorbehalten  
o = nur solange Lagervorrat vorhanden  
x = normally ex stock  
o = available while stocks last

\*\* SSP = Steilschnecke  
\*\* SSP = quick spiral

MF



	111 395 Dulofix TiCN	111 318 Spiralo 15	111 324 Spiralo 15 TiN	111 325 Spiralo 15 TiCN	111 326 Spiralo 35	111 335 Spiralo 35 TiN	111 396 Spiralo 35 TiCN	111 329 Spiralo 35 6G	111 332 Spiralo 35 TS
	6H / ISO2 B 4-5	6H / ISO2 C 2-3	6H / ISO2 C 2-3	6H / ISO2 C 2-3	6H / ISO2 C 2-3	6H / ISO2 C 2-3	6H / ISO2 C 2-3	6G / ISO3 C 2-3	6H / ISO2 C 2-3
				Alu-Guss Alu-castings 4.16					
	TiCN		TiN	TiCN		TiN	TiCN		
	T2	T2	T2	T2	T2	T2	T2	Aufmaß Oversize	tiefe Sacklöcher Deep blind holes
d	P mm	Verfügbarkeit Availability							
M 6	x 0,5								
M 6	x 0,75		x			x			
M 7	x 0,75								
M 8	x 0,5								
M 8	x 0,75		x			x			
M 8	x 1	x	x	x	x	x	x	x	x
M 9	x 1								
M 10	x 0,75								
M 10	x 1	x	x	x	x	x	x	x	x
M 10	x 1,25		x			x			
M 11	x 1								
M 12	x 1	x	x	x	x	x	x	x	x
M 12	x 1,25		x			x			
M 12	x 1,5	x	x	x	x	x	x	x	x
M 13	x 1								
M 14	x 1		x			x			
M 14	x 1,25		x			x			
M 14	x 1,5	x	x	x	x	x	x	x	x
M 15	x 1								
M 15	x 1,5								
M 16	x 1		x			x			
M 16	x 1,5	x	x	x	x	x	x	x	x
M 18	x 1								
M 18	x 1,5	x	x	x	x	x	x	x	x
M 18	x 2		x			x			
M 20	x 1								
M 20	x 1,5	x	x	x	x	x	x	x	x
M 20	x 2		x			x			
M 22	x 1								
M 22	x 1,5		x			x			
M 22	x 2		x			x			
M 24	x 1								
M 24	x 1,5		x			x			
M 24	x 2		x			x			
M 25	x 1,5		x			x			
		J.	G62	J.	J.	G62	G63	J.	J.
									J.

x = ab Lager, Zwischenverkauf vorbehalten  
o = nur solange Lagervorrat vorhanden  
x = normally ex stock  
o = available while stocks last

MF

**Metrisches ISO-Feingewinde DIN 13**  
Baumaße DIN 374, Überlaufschaft  
**ISO Metric Fine Threads, DIN 13**  
Dimensions DIN 374, Reduced shank

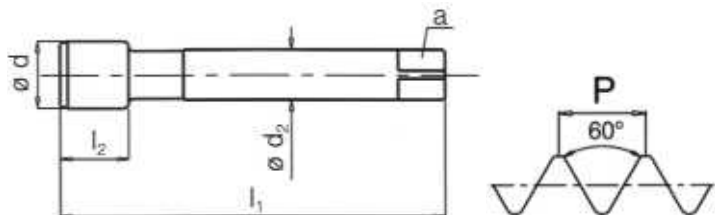

Katalog Nr. Bezeichnung	Catalogue No. Name	111 353 Spiralo 48 TS TiN	111 354 Spiralo 48 TS TiN	111 352 Spiralo 45	111 380 Hahnreiter MS	111 383 Hahnreiter MS		
Toleranz	Tolerance	6H / ISO2	6G / ISO3	6H / ISO2	6H / ISO2	6H / ISO2		
Anschnittform	Chamfer form	C	C	C	C	E		
Anschnittlänge, Gang	Chamfer length, threads	2-3	2-3	2-3	2-3	1,5-2		
für Bohrungsart	For holes							
Sonderwerkstoff	Special material			Aluminium	Messing			
Zerspanungsgruppe, siehe Ausklappseite links	Machinability-group, See folder left page	<input type="checkbox"/> P <input type="checkbox"/> <input type="checkbox"/> <input type="checkbox"/> <input type="checkbox"/> <input type="checkbox"/>	<input type="checkbox"/> P <input type="checkbox"/> <input type="checkbox"/> <input type="checkbox"/> <input type="checkbox"/> <input type="checkbox"/>	<input type="checkbox"/> <input type="checkbox"/> <input type="checkbox"/> <input checked="" type="checkbox"/> N <input type="checkbox"/>	<input type="checkbox"/> <input type="checkbox"/> <input type="checkbox"/> <input checked="" type="checkbox"/> N <input type="checkbox"/>	<input type="checkbox"/> <input type="checkbox"/> <input type="checkbox"/> <input checked="" type="checkbox"/> N <input type="checkbox"/>		
Oberfläche	Surface	TiN	TiN					
Ausführung	Variation	Sackloch 3xD blind hole 3xD	Sackloch 3xD blind hole 3xD					
Typenbeschreibung ab Seite	Type description from page	T2	T2	T2	T2			
d	P	Code	l <sub>1</sub>	l <sub>2</sub>	l <sub>2</sub>	d <sub>2</sub>	a	Verfügbarkeit Availability
mm	mm				SSP**			
M 6	x	0605	80	10		4,5	3,4	5,50
M 6	x	06075	80	17	10	4,5	3,4	5,20
M 7	x	07075	80	17		5,5	4,3	6,20
M 8	x	0805	80	13		6,0	4,9	7,50
M 8	x	08075	80	17	13	6,0	4,9	7,20
M 8	x	081	90	17	13	6,0	4,9	7,00
M 9	x	091	90	17		7,0	5,5	8,00
M 10	x	10075	90	17	12	7,0	5,5	9,20
M 10	x	101	90	17	12	7,0	5,5	9,00
M 10	x	10125	100	20	14	7,0	5,5	8,80
M 11	x	111	90	15		8,0	6,2	10,00
M 12	x	121	100	18	14	9,0	7,0	11,00
M 12	x	12125	100	18	14	9,0	7,0	10,80
M 12	x	1215	100	22	14	9,0	7,0	10,50
M 13	x	131	100	20		11,0	9,0	12,00
M 14	x	141	100	22	16	11,0	9,0	13,00
M 14	x	14125	100	22	16	11,0	9,0	12,80
M 14	x	1415	100	22	16	11,0	9,0	12,50
M 15	x	151	100	22		12,0	9,0	14,00
M 15	x	1515	100	22		12,0	9,0	13,50
M 16	x	161	100	22	16	12,0	9,0	15,00
M 16	x	1615	100	22	16	12,0	9,0	14,50
M 18	x	181	110	25		14,0	11,0	17,00
M 18	x	1815	110	25	18	14,0	11,0	16,50
M 18	x	182	125	32	25	14,0	11,0	16,00
M 20	x	201	125	25	18	16,0	12,0	19,00
M 20	x	2015	125	25	18	16,0	12,0	18,50
M 20	x	202	140	32	25	16,0	12,0	18,00
M 22	x	221	125	25	18	18,0	14,5	21,00
M 22	x	2215	125	25	18	18,0	14,5	20,50
M 22	x	222	140	32	25	18,0	14,5	20,00
M 24	x	241	140	25	18	18,0	14,5	23,00
M 24	x	2415	140	25	18	18,0	14,5	22,50
M 24	x	242	140	28	25	18,0	14,5	22,00
M 25	x	2515	140	25	18	18,0	14,5	23,50

ab M 26 x 1,5 Fortsetzung Seite: / continued on page:

./. /. /. /. /.

x = ab Lager, Zwischenverkauf vorbehalten  
o = nur solange Lagervorrat vorhanden  
x = normally ex stock  
o = available while stocks last

\*\* SSP = Steilspirale  
\*\* SSP = quick spiral

MF



		111 384 Hahn. MS 6G	111 385 Hahn. MS 6G	111 381 Gussfix	111 382 Gussfix TiN	111 370 Dulofix VS	111 371 Spiralo 35 VS	111 356 Multifix	111 357 Multifix 35	
		6G / ISO3 C 2-3	6G / ISO3 E 1,5-2	6HX C 2-3	6HX C 2-3	6H / ISO2 B 4-5	6H / ISO2 C 2-3	6H / ISO2 B 4-5	6H / ISO2 C 2-3	
		Messing Brass 3.21		Grauguss Grey cast iron 2.11 2.11 / 3.24 / 4.17		Vergütungsstähle Heat-treatable steels		Werkzeugstähle Toolsteels 1.7 / 3.23		
		<input type="checkbox"/> <input type="checkbox"/> <input type="checkbox"/> <input checked="" type="checkbox"/> <input type="checkbox"/>	<input type="checkbox"/> <input type="checkbox"/> <input type="checkbox"/> <input checked="" type="checkbox"/> <input type="checkbox"/>	<input type="checkbox"/> <input checked="" type="checkbox"/> <input type="checkbox"/> <input type="checkbox"/> <input type="checkbox"/>	<input type="checkbox"/> <input checked="" type="checkbox"/> <input type="checkbox"/> <input type="checkbox"/> <input type="checkbox"/>	<input checked="" type="checkbox"/> <input type="checkbox"/> <input type="checkbox"/> <input type="checkbox"/> <input type="checkbox"/>	<input checked="" type="checkbox"/> <input type="checkbox"/> <input type="checkbox"/> <input type="checkbox"/> <input type="checkbox"/>	<input checked="" type="checkbox"/> <input type="checkbox"/> <input type="checkbox"/> <input checked="" type="checkbox"/> <input type="checkbox"/>	<input checked="" type="checkbox"/> <input type="checkbox"/> <input type="checkbox"/> <input checked="" type="checkbox"/> <input type="checkbox"/>	
		Aufmaß Oversize	Aufmaß Oversize	Nit	TiN			Stygian	Stygian	
		T2	T2	T2	T2	T2	T2	T2	T2	T2
d	P mm	Verfügbarkeit Availability								
M 6	x 0,5									
M 6	x 0,75									
M 7	x 0,75									
M 8	x 0,5									
M 8	x 0,75									
M 8	x 1	o	x	x		x	x	x	x	
M 9	x 1									
M 10	x 0,75									
M 10	x 1	o	x	x		x	x	x	x	
M 10	x 1,25	o	x							
M 11	x 1									
M 12	x 1	o	x	x		x	x	x	x	
M 12	x 1,25	o	x							
M 12	x 1,5	o	x	x	x	x	x	x	x	
M 13	x 1									
M 14	x 1			x						
M 14	x 1,25									
M 14	x 1,5			x	x	x	x	x	x	
M 15	x 1									
M 15	x 1,5									
M 16	x 1									
M 16	x 1,5			x	x	x	x	x	x	
M 18	x 1									
M 18	x 1,5			x	x	x	x	x	x	
M 18	x 2									
M 20	x 1									
M 20	x 1,5			x	x	x	x	x	x	
M 20	x 2									
M 22	x 1									
M 22	x 1,5			x		x	x	x	x	
M 22	x 2									
M 24	x 1									
M 24	x 1,5			x		x	x	x	x	
M 24	x 2									
M 25	x 1,5									
		J.	J.	G63	J.	G63	G63	G64	G64	

x = ab Lager, Zwischenverkauf vorbehalten  
o = nur solange Lagervorrat vorhanden  
x = normally ex stock  
o = available while stocks last



MF

Metrisches ISO-Feingewinde DIN 13

Baumaße DIN 374, Überlaufschaft

ISO Metric Fine Threads, DIN 13

Dimensions DIN 374, Reduced shank

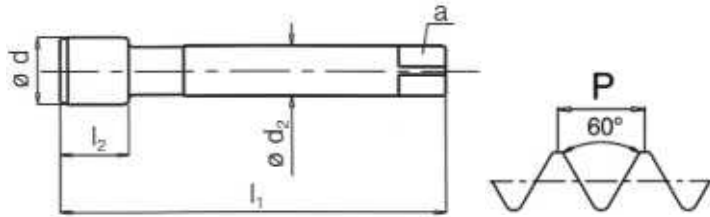

HSS-EP



Katalog Nr. Bezeichnung	Catalogue No. Name	111 360 Nirofix	111 366 Nirofix TiN	111 369 Nirofix-Z STY/WC	111 363 Nirofix 35	111 365 Nirofix 35 TS		
Toleranz	Tolerance	6H / ISO2	6H / ISO2	6HX	6H / ISO2	6H / ISO2		
Anschnittform	Chamfer form	B	B	B	C	C		
Anschnittlänge, Gang	Chamfer length, threads	4-5	4-5	4-5	2-3	2-3		
für Bohrungsart	For holes							
Sonderwerkstoff	Special material	rostfreie Stähle Stainless steels 1.9.4		rostfreie Stähle Stainless steels 1.9.5 / 3.20	rostfreie Stähle Stainless steels 1.9.4			
Zerspanungsgruppe, siehe Ausklappseite links	Machinability-group, See folder left page							
Oberfläche	Surface	VAP	TiN	STY/WC	VAP	VAP		
Ausführung	Variation					tiefe Sacklöcher Deep blind holes		
Typenbeschreibung ab Seite	Type description from page	T2	T2	T2	T2	T2		
d	P	Code	l <sub>1</sub>	l <sub>2</sub>	l <sub>2</sub>	d <sub>2</sub>	a	Verfügbarkeit Availability
mm					SSP**			
M 6	x	0,5	0605	80	10	4,5	3,4	5,50
M 6	x	0,75	06075	80	17	10	4,5	5,20
M 7	x	0,75	07075	80	17		5,5	4,3
M 8	x	0,5	0805	80	13		6,0	4,9
M 8	x	0,75	08075	80	17	13	6,0	4,9
M 8	x	1	081	90	17	13	6,0	4,9
M 9	x	1	091	90	17		7,0	5,5
M 10	x	0,75	10075	90	17	12	7,0	5,5
M 10	x	1	101	90	17	12	7,0	5,5
M 10	x	1,25	10125	100	20	14	7,0	5,5
M 11	x	1	111	90	15		8,0	6,2
M 12	x	1	121	100	18	14	9,0	7,0
M 12	x	1,25	12125	100	18	14	9,0	7,0
M 12	x	1,5	1215	100	22	14	9,0	7,0
M 13	x	1	131	100	20		11,0	9,0
M 14	x	1	141	100	22	16	11,0	9,0
M 14	x	1,25	14125	100	22	16	11,0	9,0
M 14	x	1,5	1415	100	22	16	11,0	9,0
M 15	x	1	151	100	22		12,0	9,0
M 15	x	1,5	1515	100	22		12,0	9,0
M 16	x	1	161	100	22	16	12,0	9,0
M 16	x	1,5	1615	100	22	16	12,0	9,0
M 18	x	1	181	110	25		14,0	11,0
M 18	x	1,5	1815	110	25	18	14,0	11,0
M 18	x	2	182	125	32	25	14,0	11,0
M 20	x	1	201	125	25	18	16,0	12,0
M 20	x	1,5	2015	125	25	18	16,0	12,0
M 20	x	2	202	140	32	25	16,0	12,0
M 22	x	1	221	125	25	18	18,0	14,5
M 22	x	1,5	2215	125	25	18	18,0	14,5
M 22	x	2	222	140	32	25	18,0	14,5
M 24	x	1	241	140	25	18	18,0	14,5
M 24	x	1,5	2415	140	25	18	18,0	14,5
M 24	x	2	242	140	28	25	18,0	14,5
M 25	x	1,5	2515	140	25	18	18,0	14,5

ab M 26 x 1,5 Fortsetzung Seite: / continued on page:

G63 G63 ./ G63 G63

x = ab Lager, Zwischenverkauf vorbehalten  
o = nur solange Lagervorrat vorhanden  
x = normally ex stock  
o = available while stocks last

\*\* SSP = Steilschneide  
\*\* SSP = quick spiral

# Maschinen-Gewindebohrer

## Machine Taps

# HAHNREITER HSS-E / HSS-EP\*

\* Pulvermetallurgisch erzeugter Schnellstahl / Made from powder metallurgy material

MF

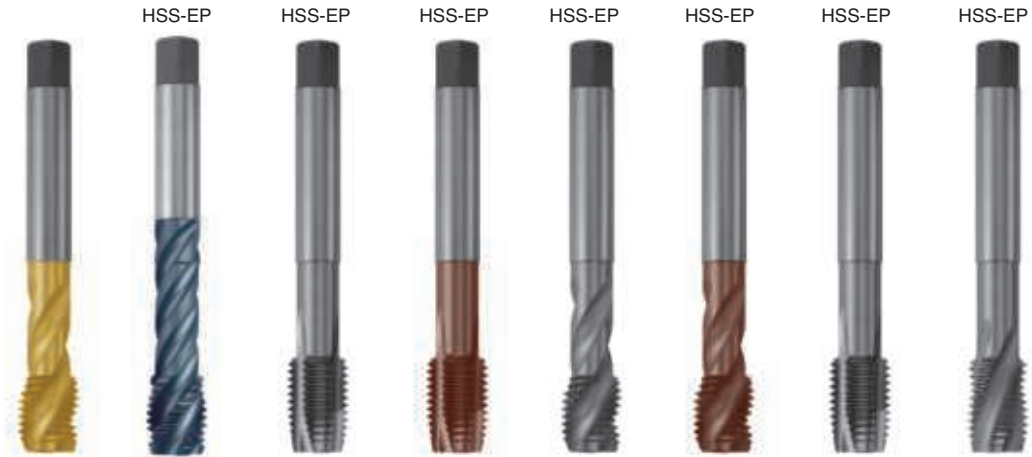

		111 367 Nirofix 35 TiN	111 368 Nirofix 48 STY/WC	111 373 Dulofix HF	111 392 Dulofix HF TiCN	111 374 Spiralo 35 HF	111 393 Spir.35 HF TiCN	111 376 Dulofix Ni	111 377 Spiralo 25 Ni	
		6H / ISO2 C 2-3	6HX C 2-3	6H / ISO2 B 4-5	6H / ISO2 B 4-5	6H / ISO2 C 2-3	6H / ISO2 C 2-3	6H / ISO2 B 5	6H / ISO2 C 3	
		rostfreie Stähle Stainless steels 1.9.4 1.9.5		hochfeste Stähle Hard materials 1.4.3 / 1.5.3 / 1.6.3 / 1.8			hochfeste Stähle Hard materials 1.4.3 / 1.5.3 / 1.6.3 / 1.8		Nickellegierungen Nickel alloys 5.25	
		TiN	STY/WC		TiCN		TiCN			
		T2	T2	T2	T2	T2	T2	T2	T2	
d	P mm	Verfügbarkeit Availability								
M 6	x 0,5									
M 6	x 0,75									
M 7	x 0,75									
M 8	x 0,5									
M 8	x 0,75	x								
M 8	x 1	x	x	x	x	x	x	x	x	
M 9	x 1									
M 10	x 0,75									
M 10	x 1	x	x	x	x	x	x	x	x	
M 10	x 1,25									
M 11	x 1									
M 12	x 1	x	x	x	x	x	x	x	x	
M 12	x 1,25									
M 12	x 1,5	x	x	x	x	x	x	x	x	
M 13	x 1									
M 14	x 1									
M 14	x 1,25									
M 14	x 1,5	x	x	x	x	x	x	x	x	
M 15	x 1									
M 15	x 1,5									
M 16	x 1									
M 16	x 1,5	x	x	x	x	x	x	x	x	
M 18	x 1									
M 18	x 1,5	x	x	x	x	x	x	x	x	
M 18	x 2									
M 20	x 1									
M 20	x 1,5	x	x	x	x	x	x	x	x	
M 20	x 2									
M 22	x 1									
M 22	x 1,5	x	x							
M 22	x 2									
M 24	x 1									
M 24	x 1,5	x	x							
M 24	x 2									
M 25	x 1,5									
		G63	J.	J.	J.	J.	J.	J.	J.	

x = ab Lager, Zwischenverkauf vorbehalten  
o = nur solange Lagervorrat vorhanden  
x = normally ex stock  
o = available while stocks last

MF

MF

Metrisches ISO-Feingewinde DIN 13

Baumaße DIN 374, Überlaufschaft

ISO Metric Fine Threads, DIN 13

Dimensions DIN 374, Reduced shank

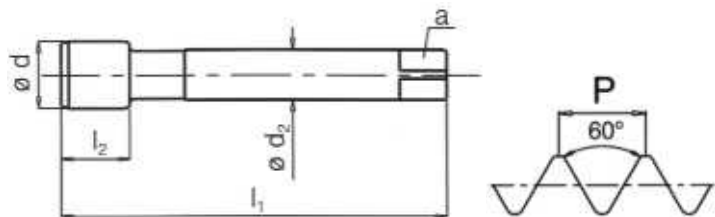

Katalog Nr. Bezeichnung	Catalogue No. Name	111 300 Hahnreiter	111 305 Dulofix	111 310 Dulofix TiN	111 318 Spiralo 15	111 326 Spiralo 35			
Toleranz	Tolerance	6H / ISO2	6H / ISO2	6H / ISO2	6H / ISO2	6H / ISO2			
Anschnittform	Chamfer form	C	B	B	C	C			
Anschnittlänge, Gang	Chamfer length, threads	2-3	4-5	4-5	2-3	2-3			
für Bohrungsart	For holes								
Sonderwerkstoff	Special material								
Zerspanungsgruppe, siehe Ausklappseite links	Machinability-group, See folder left page	<input type="checkbox"/> P <input type="checkbox"/> M <input type="checkbox"/> K <input type="checkbox"/> N	<input type="checkbox"/> P <input type="checkbox"/> M <input type="checkbox"/> K <input checked="" type="checkbox"/> N	<input type="checkbox"/> P <input type="checkbox"/> M <input type="checkbox"/> K <input checked="" type="checkbox"/> N	<input type="checkbox"/> P <input type="checkbox"/> M <input type="checkbox"/> K <input checked="" type="checkbox"/> N	<input type="checkbox"/> P <input type="checkbox"/> M <input type="checkbox"/> K <input checked="" type="checkbox"/> N			
Oberfläche	Surface			TiN					
Ausführung	Variation								
Typenbeschreibung ab Seite	Type description from page	T2	T2	T2	T2	T2			
d	P	Code	l <sub>1</sub>	l <sub>2</sub>	l <sub>2</sub>	d <sub>2</sub>	a	Verfügbarkeit	
mm	mm				SSP**			Availability	
M 26	x 1,5	2615	140	25	18	18,0	14,5	24,50	x x x x x
M 27	x 1,5	2715	140	28	22	20,0	16,0	25,50	x x x x x
M 27	x 2	272	140	28	22	20,0	16,0	25,00	x x x x x
M 28	x 1,5	2815	140	25	18	20,0	16,0	26,50	x x x x x
M 30	x 1,5	3015	150	28	22	22,0	18,0	28,50	x x x x x
M 30	x 2	302	150	28	22	22,0	18,0	28,00	x x x x x
M 32	x 1,5	3215	150	28	22	22,0	18,0	30,50	x x x x x
M 33	x 1,5	3315	160	28	22	25,0	20,0	31,50	x x x x x
M 33	x 2	332	160	28	22	25,0	20,0	31,00	x x x x x
M 34	x 1,5	3415	170	28		28,0	22,0	32,50	x x x x x
M 35	x 1,5	3515	170	28		28,0	22,0	33,50	x x x x x
M 36	x 1,5	3615	170	28		28,0	22,0	34,50	x x x x x
M 36	x 2	362	170	28		28,0	22,0	34,00	x x x x x
M 36	x 3	363	200	42	33	28,0	22,0	33,00	x x x x x
M 38	x 1,5	3815	170	28		28,0	22,0	36,50	x x x x x
M 39	x 2	392	170	28		32,0	24,0	37,00	x x x x x
M 39	x 3	393	200	42		32,0	24,0	36,00	x x x x x
M 40	x 1,5	4015	170	28		32,0	24,0	38,50	x x x x x
M 40	x 2	402	170	28		32,0	24,0	38,00	x x x x x
M 40	x 3	403	200	42		32,0	24,0	37,00	x x x x x
M 42	x 1,5	4215	170	30	25	32,0	24,0	40,50	x x x x x
M 42	x 2	422	170	30	25	32,0	24,0	40,00	x x x x x
M 42	x 3	423	200	42	35	32,0	24,0	39,00	x x x x x
M 45	x 1,5	4515	180	32	25	36,0	29,0	43,50	x x x x x
M 45	x 2	452	180	32		36,0	29,0	43,00	x x x x x
M 45	x 3	453	200	42		36,0	29,0	42,00	x x x x x
M 48	x 1,5	4815	190	32	28	36,0	29,0	46,50	x x x x x
M 48	x 2	482	190	32	28	36,0	29,0	46,00	x x x x x
M 48	x 3	483	225	42	35	36,0	29,0	45,00	x x x x x
M 50	x 1,5	5015	190	32	28	36,0	29,0	48,50	x x x x x
M 50	x 2	502	190	32		36,0	29,0	48,00	x x x x x
M 50	x 3	503	225	45		36,0	29,0	47,00	x x x x x
M 52	x 1,5	5215	190	32	28	40,0	32,0	50,50	x x x x x
M 52	x 2	522	190	32		40,0	32,0	50,00	x x x x x
M 52	x 3	523	225	45		40,0	32,0	49,00	x x x x x

Größere Ø auf Anfrage.  
Bigger Ø on request.

\*\* SSP = Steilspirale  
\*\* SSP = quick spiral

x = ab Lager, Zwischenverkauf vorbehalten  
o = nur solange Lagervorrat vorhanden  
x = normally ex stock  
o = available while stocks last

MF



MF

	111 335 Spiralo 35 TiN	111 381 Gussfix	111 360 Nirofix	111 366 Nirofix TiN	111 363 Nirofix 35	111 365 Nirofix 35 TS	111 367 Nirofix 35 TiN	111 370 Dulofix VS	111 371 Spiralo 35 VS
	6H / ISO2 C 2-3	6HX C 2-3	6H / ISO2 B 4-5	6H / ISO2 B 4-5	6H / ISO2 C 2-3	6H / ISO2 C 2-3	6H / ISO2 C 2-3	6H / ISO2 B 4-5	6H / ISO2 C 2-3
		Grauguss Grey cast iron 2.11	rostfreie Stähle Stainless steels 1.9.4				Vergütungsstähle Heat-treatable steels		
	TiN	Nit	VAP	TiN	VAP	VAP	TiN		
						tiefe Sacklöcher Deep blind holes			
	T2	T2	T2	T2	T2	T2	T2	T2	T2
d	P mm	Verfügbarkeit Availability							
M 26	x 1,5	x	x	x	x	x	x	x	x
M 27	x 1,5	x	x	x	x	x	x	x	x
M 27	x 2								
M 28	x 1,5	x	x	x	x	x	x	x	x
M 30	x 1,5	x	x	x	x	x	x	x	x
M 30	x 2								
M 32	x 1,5								
M 33	x 1,5								
M 33	x 2								
M 34	x 1,5								
M 35	x 1,5								
M 36	x 1,5								
M 36	x 2								
M 36	x 3								
M 38	x 1,5								
M 39	x 2								
M 39	x 3								
M 40	x 1,5								
M 40	x 2								
M 40	x 3								
M 42	x 1,5								
M 42	x 2								
M 42	x 3								
M 45	x 1,5								
M 45	x 2								
M 45	x 3								
M 48	x 1,5								
M 48	x 2								
M 48	x 3								
M 50	x 1,5								
M 50	x 2								
M 50	x 3								
M 52	x 1,5								
M 52	x 2								
M 52	x 3								

Weitere Typen nächste Seite  
Further types see next page

x = ab Lager, Zwischenverkaufvorbehalten  
o = nur solange Lagervorrat vorhanden  
x = normally ex stock  
o = available while stocks last

MF

**Metrisches ISO-Feingewinde DIN 13**  
Baumaße DIN 374, Überlaufschaft  
**ISO Metric Fine Threads, DIN 13**  
Dimensions DIN 374, Reduced shank

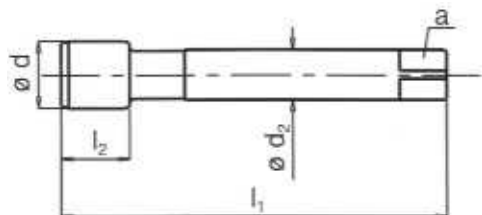

Katalog Nr. Bezeichnung	Catalogue No. Name	111 356 Multifix	111 357 Multifix 35				
Toleranz	Tolerance	6H / ISO2	6H / ISO2				
Anschnittform	Chamfer form	B	C				
Anschnittlänge, Gang	Chamfer length, threads	4-5	2-3				
für Bohrungsart	For holes						
Sonderwerkstoff	Special material	Werkzeugstähle Toolsteels 1.7 / 3.23					
Zerspanungsgruppe, siehe Ausklappseite links	Machinability-group, See folder left page	<input type="checkbox"/> P <input type="checkbox"/> N <input type="checkbox"/> <input type="checkbox"/> <input type="checkbox"/> <input type="checkbox"/>					
Oberfläche	Surface	Stygian	Stygian				
Ausführung	Variation						
Typenbeschreibung ab Seite	Type description from page	T2	T2				
d	P	Code	l <sub>1</sub>	l <sub>2</sub>	d <sub>2</sub>	a	Verfügbarkeit Availability
mm	mm			SSP**			
M 26 x 1,5	2615	140 25 18	18,0	14,5	24,50	x	x
M 27 x 1,5	2715	140 28 22	20,0	16,0	25,50	x	x
M 27 x 2	272	140 28 22	20,0	16,0	25,00		
M 28 x 1,5	2815	140 25 18	20,0	16,0	26,50	x	x
M 30 x 1,5	3015	150 28 22	22,0	18,0	28,50	x	x
M 30 x 2	302	150 28 22	22,0	18,0	28,00		
M 32 x 1,5	3215	150 28 22	22,0	18,0	30,50		
M 33 x 1,5	3315	160 28 22	25,0	20,0	31,50		
M 33 x 2	332	160 28 22	25,0	20,0	31,00		
M 34 x 1,5	3415	170 28	28,0	22,0	32,50		
M 35 x 1,5	3515	170 28	28,0	22,0	33,50		
M 36 x 1,5	3615	170 28	28,0	22,0	34,50		
M 36 x 2	362	170 28	28,0	22,0	34,00		
M 36 x 3	363	200 42 33	28,0	22,0	33,00		
M 38 x 1,5	3815	170 28	28,0	22,0	36,50		
M 39 x 2	392	170 28	32,0	24,0	37,00		
M 39 x 3	393	200 42	32,0	24,0	36,00		
M 40 x 1,5	4015	170 28	32,0	24,0	38,50		
M 40 x 2	402	170 28	32,0	24,0	38,00		
M 40 x 3	403	200 42	32,0	24,0	37,00		
M 42 x 1,5	4215	170 30 25	32,0	24,0	40,50		
M 42 x 2	422	170 30 25	32,0	24,0	40,00		
M 42 x 3	423	200 42 35	32,0	24,0	39,00		
M 45 x 1,5	4515	180 32 25	36,0	29,0	43,50		
M 45 x 2	452	180 32	36,0	29,0	43,00		
M 45 x 3	453	200 42	36,0	29,0	42,00		
M 48 x 1,5	4815	190 32 28	36,0	29,0	46,50		
M 48 x 2	482	190 32 28	36,0	29,0	46,00		
M 48 x 3	483	225 42 35	36,0	29,0	45,00		
M 50 x 1,5	5015	190 32 28	36,0	29,0	48,50		
M 50 x 2	502	190 32	36,0	29,0	48,00		
M 50 x 3	503	225 45	36,0	29,0	47,00		
M 52 x 1,5	5215	190 32 28	40,0	32,0	50,50		
M 52 x 2	522	190 32	40,0	32,0	50,00		
M 52 x 3	523	225 45	40,0	32,0	49,00		

x = ab Lager, Zwischenverkauf vorbehalten  
o = nur solange Lagervorrat vorhanden  
x = normally ex stock  
o = available while stocks last

\*\* SSP = Steilschnecke  
\*\* SSP = quick spiral





MF

**Metrisches ISO-Feingewinde DIN 13**  
Baumaße DIN 374, Überlaufschaft  
**ISO Metric Fine Threads, DIN 13**  
Dimensions DIN 374, Reduced shank

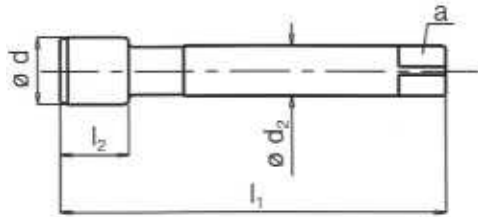

Katalog Nr. Bezeichnung	Catalogue No. Name		111 345 Drückfix N TiN						
Toleranz	Tolerance		6HX						
Anschnittform	Chamfer form		C						
Anschnittlänge, Gang	Chamfer length, threads		2-3						
für Bohrungsart	For holes								
Sonderwerkstoff	Special material	Werkstoffe mit min. 10% Bruchdehnung Materials with elongation of min. 10%							
Zerspanungsgruppe, siehe Ausklappseite links	Machinability-group, See folder left page		<input type="checkbox"/> P <input checked="" type="checkbox"/> M <input type="checkbox"/> N <input type="checkbox"/>						
Oberfläche	Surface		TiN						
Ausführung	Variation								
Typenbeschreibung ab Seite	Type description from page		T2						
d	P	Code	l <sub>1</sub>	l <sub>2</sub>	l <sub>2</sub>	d <sub>2</sub>	a		Verfügbarkeit Availability
mm					SSP**				
M 6	x 0,75	06075	80	13		4,5	3,4	5,65	x
M 8	x 0,75	08075	80	14		6,0	4,9	7,65	x
M 8	x 1	081	90	17		6,0	4,9	7,55	x
M 10	x 1	101	90	17		7,0	5,5	9,55	x
M 10	x 1,25	10125	100	20		7,0	5,5	9,40	x
M 12	x 1	121	100	20		9,0	7,0	11,55	x
M 12	x 1,25	12125	100	20		9,0	7,0	11,40	x
M 12	x 1,5	1215	100	20		9,0	7,0	11,30	x
M 14	x 1,5	1415	100	20		11,0	9,0	13,30	x
M 16	x 1,5	1615	100	22		12,0	9,0	15,30	x
M 18	x 1,5	1815	110	25		14,0	11,0	17,30	x
M 20	x 1,5	2015	125	25		16,0	12,0	19,30	x

x = ab Lager, Zwischenverkauf vorbehalten  
o = nur solange Lagervorrat vorhanden  
x = normally ex stock  
o = available while stocks last

\*\* SSP = Steilspirale  
\*\* SSP = quick spiral





UNC

Unified Grobgewinde ANSI B 1.1

Baumaße DIN 2184 Teil 2, Satz à 3 Stück

Unified Coarse Threads ANSI B 1.1

Dimensions DIN 2184 part 2, Set of 3 pieces

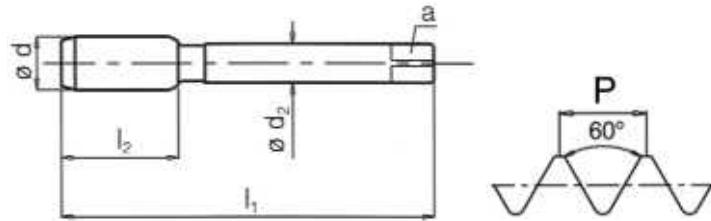

Katalog Nr. Bezeichnung	Catalogue No. Name	112 001 Hahnreiter	112 002 Hahnreiter	112 003 Hahnreiter	112 000 Hahnreiter							
Toleranz	Tolerance	Nr. 1	Nr. 2	2B	2B							
Anschnittform	Chamfer form	5	3-4	C								
Anschnittlänge, Gang	Chamfer length, threads			2-3								
für Bohrungsart	For holes											
hauptsächlich Einsatzgebiet	Main use	alle gut spanbaren Materialien bis 800 N/mm <sup>2</sup> all free machining materials up to 800 N/mm <sup>2</sup>										
Zerspanungsgruppe, siehe Ausklappseite links	Machinability-group, See folder left page	<input type="checkbox"/> P <input type="checkbox"/> K <input type="checkbox"/> N <input type="checkbox"/>	<input type="checkbox"/> P <input type="checkbox"/> K <input type="checkbox"/> N <input type="checkbox"/>	<input type="checkbox"/> P <input type="checkbox"/> K <input type="checkbox"/> N <input type="checkbox"/>	<input type="checkbox"/> P <input type="checkbox"/> K <input type="checkbox"/> N <input type="checkbox"/>							
Ausführung	Variation	Vorschneider Taper	Mittelschneider Second	Fertigschneider Bottoming	Satz à 3 Stück Set of 3 pc.							
Oberfläche	Surface											
d	P Gg/1"	Ø mm	l <sub>1</sub>	l <sub>2</sub>	d <sub>2</sub>	a	Verfügbarkeit Availability					
Nr. 1	- 64	01,85	36	8	2,8	2,1	1,55	x	x	x		x
Nr. 2	- 56	02,18	36	9	2,8	2,1	1,85	x	x	x		x
Nr. 3	- 48	02,52	40	9	2,8	2,1	2,10	x	x	x		x
Nr. 4	- 40	02,85	40	10	3,5	2,7	2,35	x	x	x		x
Nr. 5	- 40	03,18	40	11	3,5	2,7	2,65	x	x	x		x
Nr. 6	- 32	03,51	45	12	4,0	3,0	2,85	x	x	x		x
Nr. 8	- 32	04,17	45	12	4,5	3,4	3,50	x	x	x		x
Nr. 10	- 24	04,83	50	14	6,0	4,9	3,90	x	x	x		x
Nr. 12	- 24	05,49	56	16	6,0	4,9	4,50	x	x	x		x
1/4	- 20	06,35	56	16	6,0	4,9	5,10	x	x	x		x
5/16	- 18	07,94	63	22	6,0	4,9	6,60	x	x	x		x
3/8	- 16	09,53	70	22	7,0	5,5	8,00	x	x	x		x
7/16	- 14	11,11	70	24	8,0	6,2	9,40	x	x	x		x
1/2	- 13	12,70	75	25	9,0	7,0	10,80	x	x	x		x
9/16	- 12	14,29	80	30	11,0	9,0	12,20	x	x	x		x
5/8	- 11	15,88	80	32	12,0	9,0	13,50	x	x	x		x
3/4	- 10	19,05	95	32	14,0	11,0	16,50	x	x	x		x
7/8	- 9	22,23	100	32	18,0	14,5	19,50	x	x	x		x
1	- 8	25,40	110	36	18,0	14,5	22,25	x	x	x		x
1.1/8	- 7	28,58	125	40	22,0	18,0	25,00	x	x	x		x
1.1/4	- 7	31,75	125	40	22,0	18,0	28,00	x	x	x		x
1.3/8	- 6	34,93	150	50	28,0	22,0	30,75	x	x	x		x
1.1/2	- 6	38,10	150	50	28,0*	22,0	34,00	x	x	x		x
1.3/4	- 5	44,45	160	58	36,0	29,0	39,50	x	x	x		x
2	- 4,5	50,80	180	65	40,0	32,0	45,00	x	x	x		x

x = ab Lager, Zwischenverkauf vorbehalten  
o = nur solange Lagervorrat vorhanden  
x = normally ex stock  
o = available while stocks last

UNC

Unified Grobgewinde ANSI B 1.1

Baumaße DIN 2184 Teil 1, verstärkter Schaft

Unified Coarse Threads ANSI B 1.1

Dimensions DIN 2184 part 1, Reinforced shank

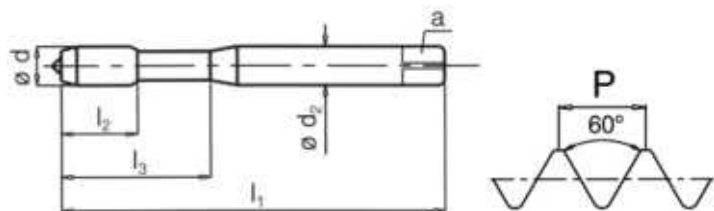

UNC

Katalog Nr. Bezeichnung	Catalogue No. Name	112 200 Hahnreiter	112 205 Dulofix	112 210 Dulofix TiN	112 295 Dulofix TiCN	112 216 Standfest 2									
Toleranz	Tolerance	2B	2B	2B	2B	2B									
Anschnittform	Chamfer form	C	B	B	B	B									
Anschnittlänge, Gang	Chamfer length, threads	2-3	4-5	4-5	4-5	4-5									
für Bohrungsart	For holes														
Sonderwerkstoff	Special material														
Zerspanungsgruppe, siehe Ausklappseite links	Machinability-group, See folder left page	<input type="checkbox"/> P <input type="checkbox"/> <input type="checkbox"/> <input type="checkbox"/> <input type="checkbox"/>	<input type="checkbox"/> P <input type="checkbox"/> <input type="checkbox"/> <input checked="" type="checkbox"/> N <input type="checkbox"/>	<input type="checkbox"/> P <input type="checkbox"/> <input type="checkbox"/> <input checked="" type="checkbox"/> N <input type="checkbox"/>	<input type="checkbox"/> P <input type="checkbox"/> <input type="checkbox"/> <input checked="" type="checkbox"/> N <input type="checkbox"/>	<input type="checkbox"/> P <input type="checkbox"/> <input type="checkbox"/> <input type="checkbox"/> <input type="checkbox"/>									
Oberfläche	Surface			TiN	TiCN										
Ausführung	Variation					2 Schmiemuten 2 oilgrooves									
Typenbeschreibung ab Seite	Type description from page	T2	T2	T2	T2	T2									
d	P	Ø	l <sub>1</sub>	l <sub>2</sub>	l <sub>3</sub>	d <sub>2</sub>	a	Verfügbarkeit Availability							
	Gg/1"	mm													
Nr. 1	-	64	01,85	45	6	10	2,8	2,1	1,55						
Nr. 2	-	56	02,18	45	6	10	2,8	2,1	1,85	x		x			
Nr. 3	-	48	02,52	50	9	14	2,8	2,1	2,10	x		x			
Nr. 4	-	40	02,85	56	10	16	3,5	2,7	2,35	x		x		x	
Nr. 5	-	40	03,18	56	10	18	3,5	2,7	2,65	x		x			
Nr. 6	-	32	03,51	56	11	20	4,0	3,0	2,85	x		x		x	
Nr. 8	-	32	04,17	63	13	21	4,5	3,4	3,50	x		x		x	
Nr. 10	-	24	04,83	70	14	25	6,0	4,9	3,90	x		x		x	
Nr. 12	-	24	05,49	80	17	30	6,0	4,9	4,50	x		x		x	
1/4	-	20	06,35	80	17	30	7,0	5,5	5,10	x		x		x	
5/16	-	18	07,94	90	18	35	8,0	6,2	6,60	x		x		x	
3/8	-	16	09,53	100	20	39	10,0	8,0	8,00	x		x		x	

x = ab Lager, Zwischenverkauf vorbehalten  
o = nur solange Lagervorrat vorhanden  
x = normally ex stock  
o = available while stocks last

UNC

Unified Grobgewinde ANSI B 1.1

Baumaße DIN 2184 Teil 1, verstärkter Schaft

Unified Coarse Threads ANSI B 1.1

Dimensions DIN 2184 part 1, Reinforced shank

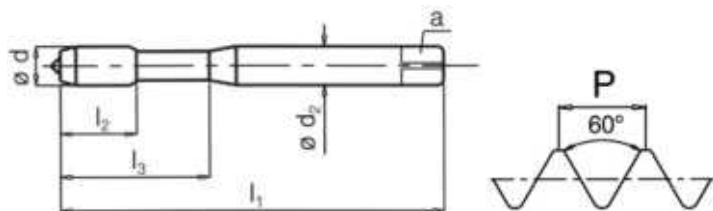

Katalog Nr. Bezeichnung	Catalogue No. Name	112 218 Spiralo 15	112 226 Spiralo 35	112 235 Spiralo 35 TiN	112 296 Spiralo 35 TiCN	112 253 Spiralo 48 TS TiN											
Toleranz	Tolerance	2B	2B	2B	2B	2B											
Anschnittform	Chamfer form	C	C	C	C	C											
Anschnittlänge, Gang	Chamfer length, threads	2-3	2-3	2-3	2-3	2-3											
für Bohrungsart	For holes																
Sonderwerkstoff	Special material																
Zerspanungsgruppe, siehe Ausklappseite links	Machinability-group, See folder left page	<input type="checkbox"/> P <input type="checkbox"/> M <input checked="" type="checkbox"/> N <input type="checkbox"/> K	<input type="checkbox"/> P <input type="checkbox"/> M <input checked="" type="checkbox"/> N <input type="checkbox"/> K	<input type="checkbox"/> P <input type="checkbox"/> M <input checked="" type="checkbox"/> N <input type="checkbox"/> K	<input type="checkbox"/> P <input type="checkbox"/> M <input checked="" type="checkbox"/> N <input type="checkbox"/> K	<input type="checkbox"/> P <input type="checkbox"/> M <input checked="" type="checkbox"/> N <input type="checkbox"/> K											
Oberfläche	Surface			TiN	TiCN	TiN											
Ausführung	Variation					tiefe Sacklöcher 3xD deep blind holes 3xD											
Typenbeschreibung ab Seite	Type description from page	T2	T2	T2	T2	T2											
d	P	Ø	l <sub>1</sub>	l <sub>2</sub>	l <sub>2</sub>	l <sub>3</sub>	d <sub>2</sub>	a	Verfügbarkeit Availability								
	Gg/1"	mm			SSP**												
Nr. 2	-	56	02,18	45	6	10	2,8	2,1	1,85	x	x						
Nr. 3	-	48	02,52	50	9	14	2,8	2,1	2,10	x	x						
Nr. 4	-	40	02,85	56	10	6	16	3,5	2,35	x	x						x
Nr. 5	-	40	03,18	56	10	6	18	3,5	2,7	x	x						
Nr. 6	-	32	03,51	56	11	7	20	4,0	3,0	x	x						x
Nr. 8	-	32	04,17	63	13	8	21	4,5	3,4	x	x						x
Nr. 10	-	24	04,83	70	14	10	25	6,0	4,9	x	x						x
Nr. 12	-	24	05,49	80	17	10	30	6,0	4,9	x	x						x
1/4	-	20	06,35	80	17	12	30	7,0	5,5	x	x						x
5/16	-	18	07,94	90	18	12	35	8,0	6,60	x	x						x
3/8	-	16	09,53	100	20	14	39	10,0	8,00	x	x						x

x = ab Lager, Zwischenverkauf vorbehalten  
o = nur solange Lagervorrat vorhanden  
x = normally ex stock  
o = available while stocks last

\*\* SSP = Steilspirale  
\*\* SSP = quick spiral

UNC

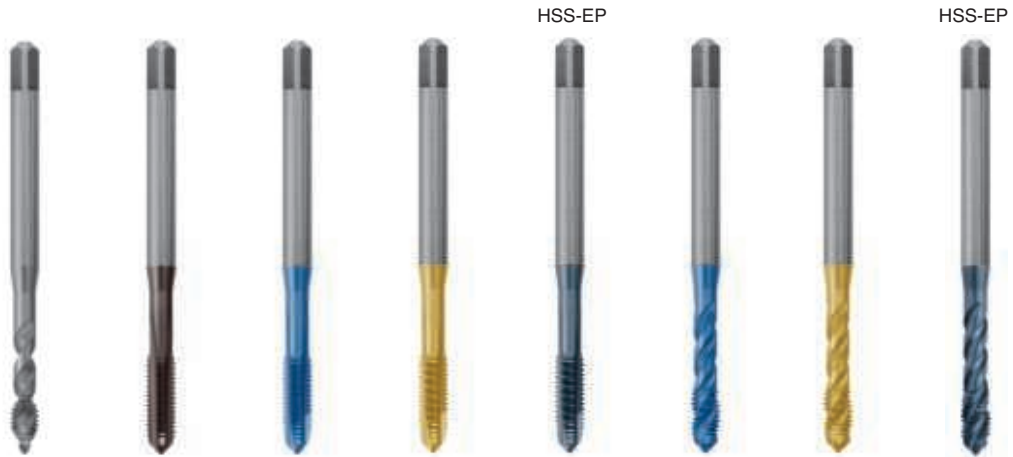

	112 252 Spiralo 45	112 281 Gussfix	112 260 Nirofix	112 266 Nirofix TiN	112 269 Nirofix-Z STY/WC	112 263 Nirofix 35	112 267 Nirofix 35 TiN	112 268 Nirofix 48 STY/WC	
	2B C 2-3	2BX C 2-3	2B B 4-5	2B B 4-5	2BX B 4-5	2B C 2-3	2B C 2-3	2BX C 2-3	
	Aluminium 3.20 / 4.14	Grauguss Grey cast iron 2.11	1.9.4	1.9.4	1.9.5 / 3.2	1.9.4	1.9.4	1.9.5 / 3.2	
	<input type="checkbox"/> <input type="checkbox"/> <input type="checkbox"/> <input checked="" type="checkbox"/> N <input type="checkbox"/>	<input type="checkbox"/> <input type="checkbox"/> <input checked="" type="checkbox"/> K <input type="checkbox"/>	<input type="checkbox"/> <input checked="" type="checkbox"/> M <input type="checkbox"/> <input type="checkbox"/>	<input checked="" type="checkbox"/> P <input checked="" type="checkbox"/> M <input checked="" type="checkbox"/> K <input type="checkbox"/>	<input checked="" type="checkbox"/> P <input checked="" type="checkbox"/> M <input type="checkbox"/> <input checked="" type="checkbox"/> N <input type="checkbox"/>	<input type="checkbox"/> <input checked="" type="checkbox"/> M <input type="checkbox"/> <input type="checkbox"/>	<input checked="" type="checkbox"/> P <input checked="" type="checkbox"/> M <input checked="" type="checkbox"/> K <input type="checkbox"/>	<input checked="" type="checkbox"/> P <input checked="" type="checkbox"/> M <input type="checkbox"/> <input checked="" type="checkbox"/> N <input type="checkbox"/>	
	2 Nuten 2 flutes	Nit	VAP	TiN	STY/WC	VAP	TiN	STY/WC	
	T2	T2	T2	T2	T2	T2	T2	T2	
d	P Gg/1"	Verfügbarkeit Availability							
Nr. 2 - 56									
Nr. 3 - 48									
Nr. 4 - 40	x	x	x	x	x	x	x	x	
Nr. 5 - 40	x	x	x	x		x	x		
Nr. 6 - 32	x	x	x	x	x	x	x	x	
Nr. 8 - 32	x	x	x	x	x	x	x	x	
Nr. 10 - 24	x	x	x	x	x	x	x	x	
Nr. 12 - 24	x	x	x			x			
1/4 - 20	x	x	x	x	x	x	x	x	
5/16 - 18	x	x	x	x	x	x	x	x	
3/8 - 16	x	x	x	x	x	x	x	x	

x = ab Lager, Zwischenverkauf vorbehalten  
o = nur solange Lagervorrat vorhanden  
x = normally ex stock  
o = available while stocks last



UNC

Unified Grobgewinde ANSI B 1.1

Baumaße DIN 2184 Teil 1, verstärkter Schaft

Unified Coarse Threads ANSI B 1.1

Dimensions DIN 2184 part 1, Reinforced shank

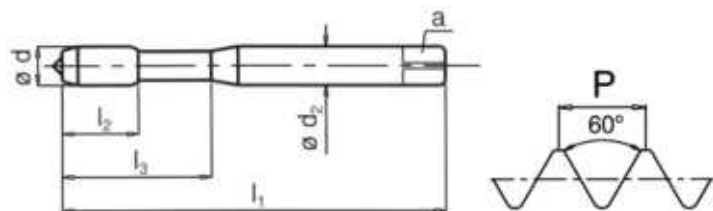

Katalog Nr. Bezeichnung	Catalogue No. Name	112 270 Dulofix VS	112 271 Spiralo 35 VS	112 256 Multifix	112 257 Multifix 35					
Toleranz	Tolerance	2B	2B	2B	2B					
Anschnittform	Chamfer form	B	C	B	C					
Anschnittlänge, Gang	Chamfer length, threads	4-5	2-3	4-5	2-3					
für Bohrungsart	For holes									
Sonderwerkstoff	Special material	Vergütungsstähle Heat-treatable steels 1.1.2/1.2.2/1.4.2/1.5.2/1.6.2/1.7		Werkzeugstähle Toolsteels 1.7 / 3.23						
Zerspanungsgruppe, siehe Ausklappseite links	Machinability-group, See folder left page	<input type="checkbox"/> P <input type="checkbox"/> <input type="checkbox"/> <input type="checkbox"/> <input type="checkbox"/> <input type="checkbox"/>	<input type="checkbox"/> P <input type="checkbox"/> <input type="checkbox"/> <input type="checkbox"/> <input type="checkbox"/>	<input type="checkbox"/> P <input type="checkbox"/> <input type="checkbox"/> <input type="checkbox"/> <input type="checkbox"/> <input type="checkbox"/> <input type="checkbox"/> <input type="checkbox"/>	<input type="checkbox"/> P <input type="checkbox"/> <input type="checkbox"/> <input type="checkbox"/> <input type="checkbox"/> <input type="checkbox"/> <input type="checkbox"/> <input type="checkbox"/>					
Oberfläche	Surface			Stygian	Stygian					
Ausführung	Variation									
Typenbeschreibung ab Seite	Type description from page	T2	T2	T2	T2					
d	P Gg/1"	Ø mm	l <sub>1</sub>	l <sub>2</sub>	l <sub>2</sub> SSP**	l <sub>3</sub>	d <sub>2</sub>	a		Verfügbarkeit Availability
Nr. 2	- 56	02,18	45	6		10	2,8	2,1	1,85	
Nr. 3	- 48	02,52	50	9		14	2,8	2,1	2,10	
Nr. 4	- 40	02,85	56	10	6	16	3,5	2,7	2,35	x
Nr. 5	- 40	03,18	56	10	6	18	3,5	2,7	2,65	x
Nr. 6	- 32	03,51	56	11	7	20	4,0	3,0	2,85	x
Nr. 8	- 32	04,17	63	13	8	21	4,5	3,4	3,50	x
Nr. 10	- 24	04,83	70	14	10	25	6,0	4,9	3,90	x
Nr. 12	- 24	05,49	80	17	10	30	6,0	4,9	4,50	
1/4	- 20	06,35	80	17	12	30	7,0	5,5	5,10	x
5/16	- 18	07,94	90	18	12	35	8,0	6,2	6,60	x
3/8	- 16	09,53	100	20	14	39	10,0	8,0	8,00	x

x = ab Lager, Zwischenverkauf vorbehalten  
o = nur solange Lagervorrat vorhanden  
x = normally ex stock  
o = available while stocks last

\*\* SSP = Steilspirale  
\*\* SSP = quick spiral

UNC



	112 273 Dulofix HF	112 292 Dulofix HF TiCN	112 274 Spiralo 35 HF	112 293 Spir.35 HF TiCN	112 276 Dulofix Ni	112 277 Spiralo 25 Ni	112 278 Dulofix Ti	112 279 Spiralo 25 Ti	
	2B B 4-5	2B B 4-5	2B C 2-3	2B C 2-3	2B B 5	2B C 3	2B B 5	2B C 3	
	hochfeste Stähle Hard materials 1.4.3 / 1.5.3 / 1.6.3 / 1.8				Nickellegierungen Nickel alloys 5.25		Titanlegierungen Titanium alloys 5.26		
	<input type="checkbox"/> P	<input type="checkbox"/> P	<input type="checkbox"/> P	<input type="checkbox"/> P	<input type="checkbox"/> S	<input type="checkbox"/> S	<input type="checkbox"/> S	<input type="checkbox"/> S	
		TiCN		TiCN			Nit	Nit	
	T2	T2	T2	T2	T2	T2	T2	T2	
d	P Gg/1"	Verfügbarkeit Availability							
Nr. 2 - 56									
Nr. 3 - 48									
Nr. 4 - 40	x	x	x	x	x	x	x	x	
Nr. 5 - 40									
Nr. 6 - 32	x	x	x	x	x	x	x	x	
Nr. 8 - 32	x	x	x	x	x	x	x	x	
Nr. 10 - 24	x	x	x	x	x	x	x	x	
Nr. 12 - 24									
1/4 - 20	x	x	x	x	x	x	x	x	
5/16 - 18	x	x	x	x	x	x	x	x	
3/8 - 16	x	x	x	x	x	x	x	x	

x = ab Lager, Zwischenverkauf vorbehalten  
o = nur solange Lagervorrat vorhanden  
x = normally ex stock  
o = available while stocks last

UNC

Unified Grobgewinde ANSI B 1.1

Baumaße DIN 2184 Teil 1, Überlaufschaff

Unified Coarse Threads ANSI B 1.1

Dimensions DIN 2184 part 1, Reduced shank

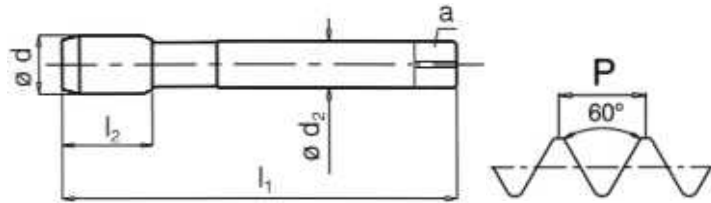

Katalog Nr. Bezeichnung	Catalogue No. Name	112 300 Hahnreiter	112 305 Dulofix	112 310 Dulofix TiN	112 395 Dulofix TiCN	112 318 Spiralo 15								
Toleranz	Tolerance	2B	2B	2B	2B	2B								
Anschnittform	Chamfer form	C	B	B	B	C								
Anschnittlänge, Gang	Chamfer length, threads	2-3	4-5	4-5	4-5	2-3								
für Bohrungsart	For holes													
Sonderwerkstoff	Special material													
Zerspanungsgruppe, siehe Ausklappseite links	Machinability-group, See folder left page	<input type="checkbox"/> P <input type="checkbox"/> <input type="checkbox"/> <input type="checkbox"/> <input type="checkbox"/>	<input type="checkbox"/> P <input type="checkbox"/> <input type="checkbox"/> <input checked="" type="checkbox"/> N <input type="checkbox"/> <input type="checkbox"/>	<input type="checkbox"/> P <input type="checkbox"/> <input type="checkbox"/> <input checked="" type="checkbox"/> N <input type="checkbox"/> <input type="checkbox"/>	<input type="checkbox"/> P <input type="checkbox"/> <input type="checkbox"/> <input checked="" type="checkbox"/> N <input type="checkbox"/> <input type="checkbox"/>	<input type="checkbox"/> P <input type="checkbox"/> <input type="checkbox"/> <input checked="" type="checkbox"/> N <input type="checkbox"/> <input type="checkbox"/>								
Oberfläche	Surface			TiN	TiCN									
Ausführung	Variation													
Typenbeschreibung ab Seite	Type description from page	T2	T2	T2	T2	T2								
d	P	Ø	l <sub>1</sub>	l <sub>2</sub>	l <sub>2</sub>	d <sub>2</sub>	a		Verfügbarkeit Availability					
	Gg/1"	mm			SSP**									
5/16	- 18	07,94	90	20		6,0	4,9	6,60	x					
3/8	- 16	09,53	100	20		7,0	5,5	8,00	x					
7/16	- 14	11,11	100	22	18	8,0	6,2	9,40		x				x
1/2	- 13	12,70	110	25	18	9,0	7,0	10,80	x	x				x
9/16	- 12	14,29	110	25	20	11,0	9,0	12,20	x	x				x
5/8	- 11	15,88	110	25	20	12,0	9,0	13,50	x	x				x
3/4	- 10	19,05	125	30	25	14,0	11,0	16,50	x	x				x
7/8	- 9	22,23	140	34	28	18,0	14,5	19,50	x	x				x
1	- 8	25,40	160	36	32	18,0	14,5	22,25	x	x				x
1.1/8	- 7	28,58	180	40		22,0	18,0	25,00	x	x				
1.1/4	- 7	31,75	180	40		22,0	18,0	28,00	x	x				
1.3/8	- 6	34,93	200	45		28,0	22,0	30,75	x	x				
1.1/2	- 6	38,10	200	45		28,0*	22,0	34,00	x	x				
1.3/4	- 5	44,45	220	56		36,0	29,0	39,50	x					
2	- 4,5	50,80	250	63		40,0	32,0	45,00	x					

x = ab Lager, Zwischenverkauf vorbehalten  
o = nur solange Lagervorrat vorhanden  
x = normally ex stock  
o = available while stocks last

\*\* SSP = Steilschneidspiral  
\*\* SSP = quick spiral

UNC

HSS-EP



UNC

	112 326 Spiralo 35	112 335 Spiralo 35 TiN	112 396 Spiralo 35 TiCN	112 353 Spiralo 48 TS TiN	112 352 Spiralo 45	112 381 Gussfix	112 360 Nirofix	112 366 Nirofix TiN	112 369 Nirofix-Z STY/WC
	2B C 2-3	2B C 2-3	2B C 2-3	2B C 2-3	2B C 2-3	2BX C 2-3	2B B 4-5	2B B 4-5	2BX B 4-5
					Aluminium 3.20 / 4.14	Grauguss Grey cast iron 2.11	rostfreie Stähle Stainless steels 1.9.4		1.9.5 / 3.2
	<input type="checkbox"/> P <input type="checkbox"/> <input type="checkbox"/> <input type="checkbox"/> N <input type="checkbox"/> <input type="checkbox"/>	<input type="checkbox"/> P <input type="checkbox"/> <input type="checkbox"/> <input type="checkbox"/> N <input type="checkbox"/> <input type="checkbox"/>	<input type="checkbox"/> P <input type="checkbox"/> <input type="checkbox"/> <input type="checkbox"/> <input type="checkbox"/> <input type="checkbox"/>	<input type="checkbox"/> P <input type="checkbox"/> <input type="checkbox"/> <input type="checkbox"/> <input type="checkbox"/> <input type="checkbox"/>	<input type="checkbox"/> <input type="checkbox"/> <input type="checkbox"/> <input type="checkbox"/> N <input type="checkbox"/> <input type="checkbox"/>	<input type="checkbox"/> <input type="checkbox"/> <input type="checkbox"/> K <input type="checkbox"/> <input type="checkbox"/> <input type="checkbox"/>	<input type="checkbox"/> <input type="checkbox"/> M <input type="checkbox"/> <input type="checkbox"/> <input type="checkbox"/> <input type="checkbox"/>	<input type="checkbox"/> P <input type="checkbox"/> M <input type="checkbox"/> K <input type="checkbox"/> <input type="checkbox"/> <input type="checkbox"/>	<input type="checkbox"/> P <input type="checkbox"/> M <input type="checkbox"/> N <input type="checkbox"/> <input type="checkbox"/>
		TiN	TiCN	TiN		Nit	VAP	TiN	STY/WC
	T2	T2	T2	T2	T2	T2	T2	T2	T2
d	P Gg/1"	Verfügbarkeit Availability							
5/16	- 18					<input type="checkbox"/> O			
3/8	- 16					<input checked="" type="checkbox"/> X			
7/16	- 14	<input checked="" type="checkbox"/> X	<input checked="" type="checkbox"/> X	<input checked="" type="checkbox"/> X	<input checked="" type="checkbox"/> X	<input checked="" type="checkbox"/> X	<input checked="" type="checkbox"/> X	<input checked="" type="checkbox"/> X	<input checked="" type="checkbox"/> X
1/2	- 13	<input checked="" type="checkbox"/> X	<input checked="" type="checkbox"/> X	<input checked="" type="checkbox"/> X	<input checked="" type="checkbox"/> X	<input checked="" type="checkbox"/> X	<input checked="" type="checkbox"/> X	<input checked="" type="checkbox"/> X	<input checked="" type="checkbox"/> X
9/16	- 12	<input checked="" type="checkbox"/> X	<input checked="" type="checkbox"/> X			<input checked="" type="checkbox"/> X	<input checked="" type="checkbox"/> X	<input checked="" type="checkbox"/> X	<input checked="" type="checkbox"/> X
5/8	- 11	<input checked="" type="checkbox"/> X	<input checked="" type="checkbox"/> X	<input checked="" type="checkbox"/> X	<input checked="" type="checkbox"/> X	<input checked="" type="checkbox"/> X	<input checked="" type="checkbox"/> X	<input checked="" type="checkbox"/> X	<input checked="" type="checkbox"/> X
3/4	- 10	<input checked="" type="checkbox"/> X	<input checked="" type="checkbox"/> X	<input checked="" type="checkbox"/> X	<input checked="" type="checkbox"/> X	<input checked="" type="checkbox"/> X	<input checked="" type="checkbox"/> X	<input checked="" type="checkbox"/> X	<input checked="" type="checkbox"/> X
7/8	- 9	<input checked="" type="checkbox"/> X	<input checked="" type="checkbox"/> X			<input checked="" type="checkbox"/> X	<input checked="" type="checkbox"/> X	<input checked="" type="checkbox"/> X	<input checked="" type="checkbox"/> X
1	- 8	<input checked="" type="checkbox"/> X	<input checked="" type="checkbox"/> X			<input checked="" type="checkbox"/> X	<input checked="" type="checkbox"/> X	<input checked="" type="checkbox"/> X	<input checked="" type="checkbox"/> X
1.1/8	- 7	<input checked="" type="checkbox"/> X							
1.1/4	- 7	<input checked="" type="checkbox"/> X							
1.3/8	- 6	<input checked="" type="checkbox"/> X							
1.1/2	- 6	<input checked="" type="checkbox"/> X							
1.3/4	- 5	<input checked="" type="checkbox"/> X							
2	- 4,5	<input checked="" type="checkbox"/> X							

x = ab Lager, Zwischenverkauf vorbehalten  
o = nur solange Lagervorrat vorhanden  
x = normally ex stock  
o = available while stocks last

UNC

Unified Grobgewinde ANSI B 1.1

Baumaße DIN 2184 Teil 1, Überlaufschaff

Unified Coarse Threads ANSI B 1.1

Dimensions DIN 2184 part 1, Reduced shank

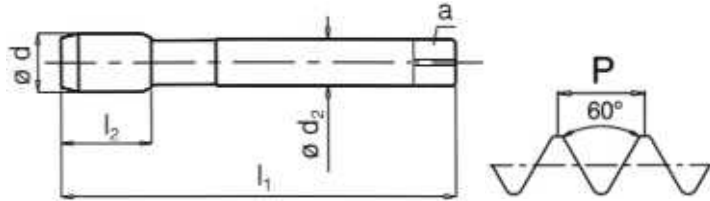

HSS-EP



Katalog Nr. Bezeichnung	Catalogue No. Name	112 363 Nirofix 35	112 367 Nirofix 35 TiN	112 368 Nirofix 48 STY/WC	112 370 Dulofix VS	112 371 Spiralo 35 VS			
Toleranz	Tolerance	2B	2B	2BX	2B	2B			
Anschnittform	Chamfer form	C	C	C	B	C			
Anschnittlänge, Gang	Chamfer length, threads	2-3	2-3	2-3	4-5	2-3			
für Bohrungsart	For holes								
Sonderwerkstoff	Special material	rostfreie Stähle Stainless steels			Vergütungsstähle Heat-treatable steels				
Zerspanungsgruppe, siehe Ausklappseite links	Machinability-group, See folder left page	1.9.4	1.9.4	1.9.5					
Oberfläche	Surface	VAP	TiN	STY/WC					
Ausführung	Variation								
Typenbeschreibung ab Seite	Type description from page	T2	T2	T2	T2	T2			
d	P Gg/1"	Ø mm	l <sub>1</sub>	l <sub>2</sub>	l <sub>2</sub> SSP**	d <sub>2</sub>	a		Verfügbarkeit Availability
5/16	- 18	07,94	90	20		6,0	4,9	6,60	
3/8	- 16	09,53	100	20		7,0	5,5	8,00	
7/16	- 14	11,11	100	22	18	8,0	6,2	9,40	x
1/2	- 13	12,70	110	25	18	9,0	7,0	10,80	x
9/16	- 12	14,29	110	25	20	11,0	9,0	12,20	x
5/8	- 11	15,88	110	25	20	12,0	9,0	13,50	x
3/4	- 10	19,05	125	30	25	14,0	11,0	16,50	x
7/8	- 9	22,23	140	34	28	18,0	14,5	19,50	x
1	- 8	25,40	160	36	32	18,0	14,5	22,25	x
1.1/8	- 7	28,58	180	40		22,0	18,0	25,00	
1.1/4	- 7	31,75	180	40		22,0	18,0	28,00	
1.3/8	- 6	34,93	200	45		28,0	22,0	30,75	
1.1/2	- 6	38,10	200	45		32,0	24,0	34,00	
1.3/4	- 5	44,45	220	56		36,0	29,0	39,50	
2	- 4,5	50,80	250	63		40,0	32,0	45,00	

x = ab Lager, Zwischenverkauf vorbehalten  
o = nur solange Lagervorrat vorhanden  
x = normally ex stock  
o = available while stocks last

\*\* SSP = Steilschneidspiral  
\*\* SSP = quick spiral

# Maschinen-Gewindebohrer

## Machine Taps

# HAHNREITER HSS-E / HSS-EP\*

\* Pulvermetallurgisch erzeugter Schnellstahl / Made from powder metallurgy material

### UNC



	112 356 Multifix	112 357 Multifix 35	112 373 Dulofix HF	112 392 Dulo. HF TiCN	112 374 Spiralo 35 HF	112 393 Spir.35 HF TiCN	112 376 Dulofix Ni	112 377 Spiralo 25 Ni
	2B B 4-5	2B C 2-3	2B B 4-5	2B B 4-5	2B C 2-3	2B C 2-3	2B B 5	2B C 3
	Werkzeugstähle Toolsteels 1.7 / 3.23			hochfeste Stähle Hard materials 1.4.3/1.5.3 / 1.6.3/1.8			Nickellegierungen Nickel alloys 5.25	
	<input type="checkbox"/> P <input type="checkbox"/> N <input type="checkbox"/>	<input type="checkbox"/> P <input type="checkbox"/> N <input type="checkbox"/>	<input type="checkbox"/> P <input type="checkbox"/> <input type="checkbox"/> <input type="checkbox"/> <input type="checkbox"/>	<input type="checkbox"/> P <input type="checkbox"/> <input type="checkbox"/> <input type="checkbox"/> <input type="checkbox"/>	<input type="checkbox"/> P <input type="checkbox"/> <input type="checkbox"/> <input type="checkbox"/> <input type="checkbox"/>	<input type="checkbox"/> P <input type="checkbox"/> <input type="checkbox"/> <input type="checkbox"/> <input type="checkbox"/>	<input type="checkbox"/> <input type="checkbox"/> <input type="checkbox"/> <input type="checkbox"/> <input type="checkbox"/> S	<input type="checkbox"/> <input type="checkbox"/> <input type="checkbox"/> <input type="checkbox"/> <input type="checkbox"/> S
	Stygian	Stygian		TiCN		TiCN		
	T2	T2	T2	T2	T2	T2	T2	T2
d	P	Verfügbarkeit						
	Gg/1"	Availability						
5/16	- 18							
3/8	- 16							
7/16	- 14	x	x	x	x	x	x	x
1/2	- 13	x	x	x	x	x	x	x
9/16	- 12	x	x	x	x	x		
5/8	- 11	x	x	x	x	x		
3/4	- 10	x	x	x	x	x		
7/8	- 9	x	x					
1	- 8	x	x					
1.1/8	- 7							
1.1/4	- 7							
1.3/8	- 6							
1.1/2	- 6							
1.3/4	- 5							
2	- 4,5							

x = ab Lager, Zwischenverkauf vorbehalten  
o = nur solange Lagervorrat vorhanden  
x = normally ex stock  
o = available while stocks last

UNC



UNC

Unified Grobgewinde ANSI B 1.1

Baumaße Werksnorm

Unified Coarse Threads ANSI B 1.1

Dimensions manufacturer's standard

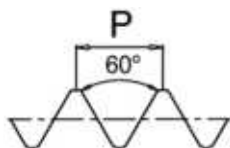
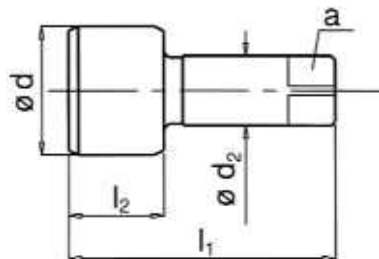

Katalog Nr. Bezeichnung	Catalogue No. Name	112 600 Automat MS	112 619 Automat 20 MS-Z	112 616 Automat 20 Sty	112 607 Automat 20	112 613 Automat 20 TiN													
Toleranz	Tolerance	2B	2BX	2BX	2BX	2BX													
Anschnittform	Chamfer form	E	E	E	E	E													
Anschnittlänge, Gang	Chamfer length, threads	1,5-2	1,5-2	1,5-2	1,5-2	1,5-2													
für Bohrungsart	For holes																		
Sonderwerkstoff	Special material	Messing Brass 3.21	Cu-Sonderlegierungen, bleifrei, bleireduziert Special copper alloys, leadfree, reduced lead 3.22	Automatenstahl free cutting steel 1.2	Automatenstahl free cutting steel 1.2	rostfreie Stähle stainless steel 1.9.4 / 1.9.5													
Zerspanungsgruppe, siehe Ausklappseite links	Machinability-group, See folder left page	<input type="checkbox"/> <input type="checkbox"/> <input type="checkbox"/> <input checked="" type="checkbox"/>	<input type="checkbox"/> <input type="checkbox"/> <input checked="" type="checkbox"/> <input type="checkbox"/>	<input type="checkbox"/> <input type="checkbox"/> <input checked="" type="checkbox"/> <input type="checkbox"/>	<input checked="" type="checkbox"/> <input type="checkbox"/> <input type="checkbox"/> <input type="checkbox"/> <input type="checkbox"/> <input type="checkbox"/>	<input checked="" type="checkbox"/> <input type="checkbox"/> <input type="checkbox"/> <input type="checkbox"/> <input type="checkbox"/> <input type="checkbox"/>													
Oberfläche	Surface			Stygian	VAP	TiN													
Ausführung	Variation																		
Typenbeschreibung ab Seite	Type description from page	T2	T2	T2	T2	T2													
d	P	Ø	l <sub>1</sub>	l <sub>2</sub>	d <sub>2</sub>	a	Verfügbarkeit Availability												
	Gg/1"	mm																	
5/16	-	18	07,94	70	17	6,0	4,9	6,60	x	x	x	x	x	x	x	x	x	x	x
3/8	-	16	09,53	70	22	8,0	6,2	8,00	x	x	x	x	x	x	x	x	x	x	x
7/16	-	14	11,11	70	22	9,0	7,0	9,40	x	x	x	x	x	x	x	x	x	x	x
1/2	-	13	12,70	70	22	9,0	7,0	10,80	x	x	x	x	x	x	x	x	x	x	x
9/16	-	12	14,29	70	25	10,0	8,0	12,20	x	x	x	x	x	x	x	x	x	x	x
5/8	-	11	15,88	70	25	12,0	9,0	13,50	x	x	x	x	x	x	x	x	x	x	x
3/4	-	10	19,05	70	28	16,0 (15,0)*	12,0	16,50	x	x	x	x	x	x	x	x	x	x	x

\*solange Lagervorrat liefern wir mit Schaft Ø 15,0  
\*as long as available we will send shank Ø 15,0

x = ab Lager, Zwischenverkauf vorbehalten  
o = nur solange Lagervorrat vorhanden  
x = normally ex stock  
o = available while stocks last

UNC

Unified Grobgewinde ANSI B 1.1

Baumaße DIN 2184 Teil 1

Unified Coarse Threads ANSI B 1.1

Dimensions DIN 2184 part 1

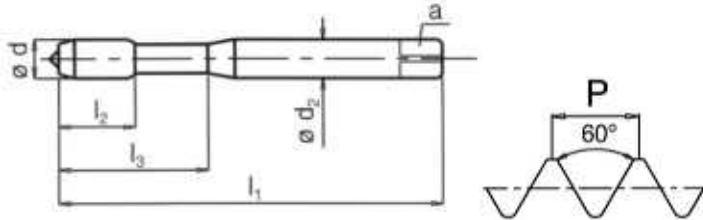

UNC

Katalog Nr. Bezeichnung	Catalogue No. Name	112 245 Drückfix N TiN	112 345 Drückfix N TiN											
Toleranz	Tolerance	2BX	2BX											
Anschnittform	Chamfer form	C	C											
Anschnittlänge, Gang	Chamfer length, threads	2-3	2-3											
für Bohrungsart	For holes													
Sonderwerkstoff	Special material	Werkstoffe mit min. 10% Bruchdehnung Materials with elongation of min. 10%												
Zerspanungsgruppe, siehe Ausklappseite links	Machinability-group, See folder left page	<input type="checkbox"/> P <input type="checkbox"/> M <input type="checkbox"/> N <input type="checkbox"/>												
Oberfläche	Surface	TiN	TiN											
Ausführung	Variation													
Typenbeschreibung ab Seite	Type description from page	T2	T2											
d	P Gg/1"	Ø mm	l <sub>1</sub>	l <sub>2</sub>	l <sub>2</sub> SSP**	l <sub>3</sub>	d <sub>2</sub>	a		Verfügbarkeit Availability				
Nr. 2	- 56	02,18												
Nr. 3	- 48	02,52												
Nr. 4	- 40	02,85	56	11		16	3,5	2,7	2,55	x				
Nr. 5	- 40	03,18	56	11		18	3,5	2,7	2,90	x				
Nr. 6	- 32	03,51	56	12		20	4,0	3,0	3,15	x				
Nr. 8	- 32	04,17	63	13		21	4,5	3,4	3,80	x				
Nr. 10	- 24	04,83	70	14		25	6,0	4,9	4,35	x				
Nr. 12	- 24	05,49	80	16		30	6,0	4,9	5,00					
1/4	- 20	06,35	80	16		30	7,0	5,5	5,75	x				
5/16	- 18	07,94	90	18		35	8,0	6,2	7,30	x				
3/8	- 16	09,53	100	20		39	10,0	8,0	8,80	x				
7/16	- 14	11,11	100	22			8,0	6,2	10,30				x	
1/2	- 13	12,70	110	25			9,0	7,0	11,80				x	
9/16	- 12	14,29	110	30			11,0	9,0	13,30				x	
5/8	- 11	15,88	110	30			12,0	9,0	14,80				x	
3/4	- 10	19,05	125	33			14,0	11,0	17,90				x	

x = ab Lager, Zwischenverkauf vorbehalten  
o = nur solange Lagervorrat vorhanden  
x = normally ex stock  
o = available while stocks last

\*\* SSP = Steilspirale  
\*\* SSP = quick spiral

**EG-UNC**

**Unified Grobgewinde für Draht-Gewindeeinsätze NASM 33537**

Baumaße DIN 2184 Teil 1, verstärkter Schaft, >= 3/8" Überlaufschaft

**Unified Coarse Threads for wire inserts NASM 33537**

Dimensions DIN 2184 part 1, Reinforced shank, >= 3/8" Reduced shank

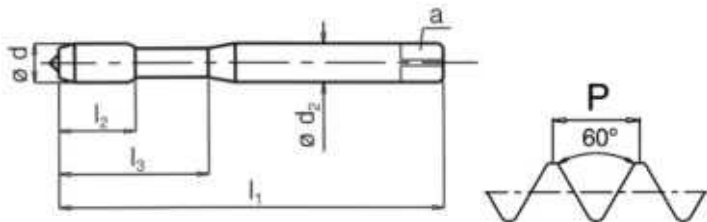

EG-UNC

Katalog Nr. Bezeichnung	Catalogue No. Name		135 205 Dulofix	135 226 Spiralo 35	135 252 Spiralo 45					
Toleranz	Tolerance		2B	2B	2B					
Anschnittform	Chamfer form		B	C	C					
Anschnittlänge, Gang	Chamfer length, threads		4-5	2-3	2-3					
für Bohrungsart	For holes									
Sonderwerkstoff	Special material				Aluminium 3.20 / 4.14					
Zerspanungsgruppe, siehe Ausklappseite links	Machinability-group, See folder left page		<input type="checkbox"/> P <input type="checkbox"/> <input type="checkbox"/> <input type="checkbox"/> <input type="checkbox"/> <input type="checkbox"/> <input type="checkbox"/> <input type="checkbox"/> <input type="checkbox"/> <input type="checkbox"/> <input type="checkbox"/>	<input type="checkbox"/> P <input type="checkbox"/> <input type="checkbox"/> <input type="checkbox"/> <input type="checkbox"/> <input type="checkbox"/> <input type="checkbox"/> <input type="checkbox"/> <input type="checkbox"/> <input type="checkbox"/>	<input type="checkbox"/> <input type="checkbox"/> <input type="checkbox"/> <input type="checkbox"/> <input type="checkbox"/> <input type="checkbox"/> <input type="checkbox"/> <input type="checkbox"/> <input type="checkbox"/> <input type="checkbox"/>					
Oberfläche	Surface									
Ausführung	Variation									
Typenbeschreibung ab Seite	Type description from page		T2	T2	T2					
d	P Gg/1"	Code mm	l <sub>1</sub>	l <sub>2</sub>	l <sub>2</sub> SSP**	l <sub>3</sub>	d <sub>2</sub>	a		Verfügbarkeit Availability
EG Nr. 4	- 40	02,85	63	12	6	21	4,5	3,4	3,10	x
EG Nr. 6	- 32	03,51	70	14	10	25	6,0	4,9	3,80	x
EG Nr. 8	- 32	04,17	80	17	10	30	6,0	4,9	4,40	x
EG 1/4	- 20	06,35	90	18	12	35	8,0	6,2	6,70	x
EG 5/16	- 18	07,94	100	20	14	39	10,0	8,0	8,40	x

>= 3/8" Überlaufschaft  
>= 3/8" reduced shank

Katalog Nr. Bezeichnung	Catalogue No. Name		135 305 Dulofix	135 326 Spiralo 35	135 352 Spiralo 45	
Toleranz	Tolerance		2B	2B	2B	
EG 3/8	- 16	09,53	100	22	14	9,0 7,0 10,00
EG 1/2	- 13	12,70	110	25	20	12,0 9,0 13,30

x = ab Lager, Zwischenverkauf vorbehalten  
o = nur solange Lagervorrat vorhanden  
x = normally ex stock  
o = available while stocks last

\*\* SSP = Steilschnecke  
\*\* SSP = quick spiral

UNF

Unified Feingewinde ANSI B 1.1

Baumaße DIN 2184 Teil 2, Satz à 2 Stück

Unified Fine Threads ANSI B 1.1

Dimensions DIN 2184 part 2, Set of 2 pieces

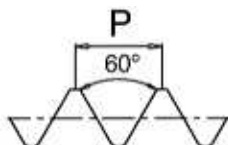
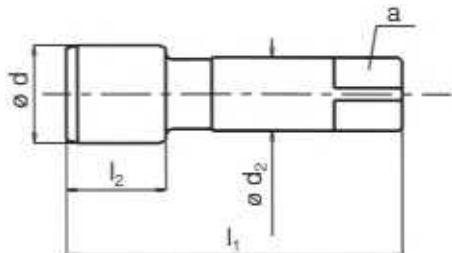

Katalog Nr. Bezeichnung	Catalogue No. Name	113 061 Hahnreiter	113 062 Hahnreiter	113 060 Hahnreiter						
Toleranz	Tolerance	Nr. 1	2B	2B						
Anschnittform	Chamfer form	5	C							
Anschnittlänge, Gang für Bohrungsart	Chamfer length, threads For holes									
hauptsächlich Einsatzgebiet	Main use	alle gut spanbaren Materialien bis 800 N/mm <sup>2</sup> all free machining materials up to 800 N/mm <sup>2</sup>								
Zerspanungsgruppe, siehe Ausklappseite links	Machinability-group, See folder left page									
Ausführung	Variation	Vorschneider Taper	Fertigschneider Bottoming	Satz à 2 Stück Set of 2 pc.						
Oberfläche	Surface									
d	P Gg/1"	Ø mm	l <sub>1</sub>	l <sub>2</sub>	d <sub>2</sub>	a		Verfügbarkeit Availability		
Nr. 1	- 72	01,85	36	8	2,8	2,1	1,55	x	x	x
Nr. 2	- 64	02,18	36	9	2,8	2,1	1,85	x	x	x
Nr. 3	- 56	02,52	40	9	2,8	2,1	2,15	x	x	x
Nr. 4	- 48	02,85	40	11	3,5	2,7	2,40	x	x	x
Nr. 5	- 44	03,18	40	11	3,5	2,7	2,70	x	x	x
Nr. 6	- 40	03,51	45	10	4,0	3,0	2,95	x	x	x
Nr. 8	- 36	04,17	45	12	4,5	3,4	3,50	x	x	x
Nr. 10	- 32	04,83	50	14	6,0	4,9	4,10	x	x	x
Nr. 12	- 28	05,49	56	16	6,0	4,9	4,60	x	x	x
1/4	- 28	06,35	56	16	6,0	4,9	5,50	x	x	x
5/16	- 24	07,94	63	20	6,0	4,9	6,90	x	x	x
3/8	- 24	09,53	63	22	7,0	5,5	8,50	x	x	x
7/16	- 20	11,11	70	22	8,0	6,2	9,90	x	x	x
1/2	- 20	12,70	70	22	9,0	7,0	11,50	x	x	x
9/16	- 18	14,29	70	22	11,0	9,0	12,90	x	x	x
5/8	- 18	15,88	70	22	12,0	9,0	14,50	x	x	x
3/4	- 16	19,05	80	22	14,0	11,0	17,50	x	x	x
7/8	- 14	22,23	80	22	18,0	14,5	20,40	x	x	x
1	- 12	25,40	90	22	18,0	14,5	23,25	x	x	x
1.1/8	- 12	28,58	90	22	22,0	18,0	26,50	x	x	x
1.1/4	- 12	31,75	90	22	22,0	18,0	29,50	x	x	x
1.3/8	- 12	34,93	125	30	28,0	22,0	32,75	x	x	x
1.1/2	- 12	38,10	125	30	28,0	22,0	36,00	x	x	x

x = ab Lager, Zwischenverkauf vorbehalten  
o = nur solange Lagervorrat vorhanden  
x = normally ex stock  
o = available while stocks last

UNF

Unified Feingewinde ANSI B 1.1

Baumaße Werksnorm

Unified Fine Threads ANSI B 1.1

Dimensions manufacturer's standard

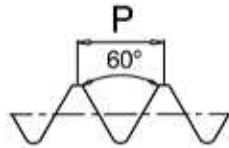
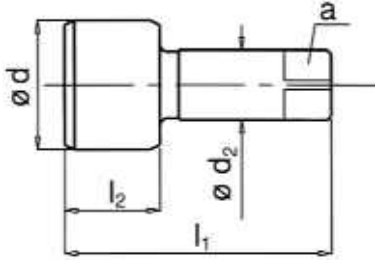

Katalog Nr. Bezeichnung	Catalogue No. Name	113 600 Automat MS	113 619 Automat 20 MS-Z	113 616 Automat 20 Sty	113 607 Automat 20	113 613 Automat 20 TiN						
Toleranz	Tolerance	2B	2BX	2BX	2BX	2BX						
Anschnittform	Chamfer form	E	E	E	E	E						
Anschnittlänge, Gang	Chamfer length, threads	1,5-2	1,5-2	1,5-2	1,5-2	1,5-2						
für Bohrungsart	For holes											
Sonderwerkstoff	Special material	Messing Brass 3.21	Cu-Sonderlegierungen, bleifrei, bleireduziert Special copper alloys, leadfree, reduced lead 3.22		Automatenstahl free cutting steel 1.2	rostfreie Stähle stainless steel 1.9.4 / 1.9.5						
Zerspanungsgruppe, siehe Ausklappseite links	Machinability-group, See folder left page	<input type="checkbox"/> <input type="checkbox"/> <input type="checkbox"/> <input checked="" type="checkbox"/>	<input type="checkbox"/> <input type="checkbox"/> <input type="checkbox"/> <input checked="" type="checkbox"/>	<input type="checkbox"/> <input type="checkbox"/> <input type="checkbox"/> <input checked="" type="checkbox"/>	<input checked="" type="checkbox"/> <input type="checkbox"/> <input type="checkbox"/> <input type="checkbox"/> <input type="checkbox"/> <input type="checkbox"/>	<input type="checkbox"/> <input checked="" type="checkbox"/> <input type="checkbox"/> <input type="checkbox"/> <input type="checkbox"/> <input type="checkbox"/>						
Oberfläche	Surface			Stygian	VAP	TiN						
Ausführung	Variation											
Typenbeschreibung ab Seite	Type description from page	T2	T2	T2	T2	T2						
d	P Gg/1"	Code	$l_1$	$l_2$	$d_2$	a		Verfügbarkeit Availability				
5/16	- 24	07,94	70	17	6,0	4,9	6,90	x	x	x	x	x
3/8	- 24	09,53	70	22	8,0	6,2	8,50	x	x	x	x	x
7/16	- 20	11,11	70	18	9,0	7,0	9,90	x	x	x	x	x
1/2	- 20	12,70	70	20	9,0	7,0	11,50	x	x	x	x	x
9/16	- 18	14,29	70	20	10,0	8,0	12,90	x	x	x	x	x
5/8	- 18	15,88	70	20	12,0	9,0	14,50	x	x	x	x	x
3/4	- 16	19,05	70	22	16,0 (15,0)*	12,0	17,50	x	x	x	x	x
7/8	- 14	22,23	70	22	16,0 (15,0)*	12,0	20,40					
1	- 12	25,40	70	24	18,0	14,5	23,25	x	x	x	x	x

\*solange Lagervorrat liefern wir mit Schaft  $\phi$  15,0  
\*as long as available we will send shank  $\phi$  15,0

x = ab Lager, Zwischenverkauf vorbehalten  
o = nur solange Lagervorrat vorhanden  
x = normally ex stock  
o = available while stocks last

UNF

Unified Feingewinde ANSI B 1.1

Baumaße DIN 2184 Teil 1, verstärkter Schaft

Unified Fine Threads ANSI B 1.1

Dimensions DIN 2184 part 1, Reinforced shank

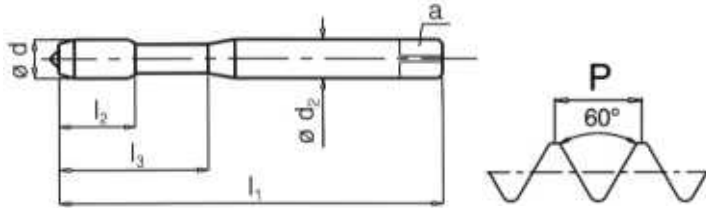

Katalog Nr. Bezeichnung	Catalogue No. Name	113 200 Hahnreiter	113 205 Dulofix	113 210 Dulofix TiN	113 295 Dulofix TiCN	113 216 Standfest 2				
Toleranz	Tolerance	2B	2B	2B	2B	2B				
Anschnittform	Chamfer form	C	B	B	B	B				
Anschnittlänge, Gang	Chamfer length, threads	2-3	4-5	4-5	4-5	4-5				
für Bohrungsart	For holes									
Sonderwerkstoff	Special material									
Zerspanungsgruppe, siehe Ausklappseite links	Machinability-group, See folder left page	<input type="checkbox"/> P <input type="checkbox"/> <input type="checkbox"/> <input type="checkbox"/> <input type="checkbox"/>	<input type="checkbox"/> P <input type="checkbox"/> <input type="checkbox"/> <input checked="" type="checkbox"/> N <input type="checkbox"/>	<input type="checkbox"/> P <input type="checkbox"/> <input type="checkbox"/> <input checked="" type="checkbox"/> N <input type="checkbox"/>	<input type="checkbox"/> P <input type="checkbox"/> <input type="checkbox"/> <input checked="" type="checkbox"/> N <input type="checkbox"/>	<input type="checkbox"/> P <input type="checkbox"/> <input type="checkbox"/> <input type="checkbox"/> <input type="checkbox"/>				
Oberfläche	Surface			TiN	TiCN					
Ausführung	Variation					2 Schmiemuten 2 oilgrooves				
Typenbeschreibung ab Seite	Type description from page	T2	T2	T2	T2	T2				
d	P Gg/1"	Ø mm	l <sub>1</sub>	l <sub>2</sub>	l <sub>3</sub>	d <sub>2</sub>	a		Verfügbarkeit Availability	
Nr. 1	- 72	01,85	45	6	10	2,8	2,1	1,55	<input type="radio"/> o	
Nr. 2	- 64	02,18	45	6	10	2,8	2,1	1,85	<input checked="" type="radio"/> x	<input checked="" type="radio"/> x
Nr. 3	- 56	02,52	50	9	14	2,8	2,1	2,15	<input checked="" type="radio"/> x	<input checked="" type="radio"/> x
Nr. 4	- 48	02,85	56	10	16	3,5	2,7	2,40	<input checked="" type="radio"/> x	<input checked="" type="radio"/> x
Nr. 5	- 44	03,18	56	10	18	3,5	2,7	2,70	<input checked="" type="radio"/> x	<input checked="" type="radio"/> x
Nr. 6	- 40	03,51	56	11	20	4,0	3,0	2,95	<input checked="" type="radio"/> x	<input checked="" type="radio"/> x
Nr. 8	- 36	04,17	63	13	21	4,5	3,4	3,50	<input checked="" type="radio"/> x	<input checked="" type="radio"/> x
Nr. 10	- 32	04,83	70	14	25	6,0	4,9	4,10	<input checked="" type="radio"/> x	<input checked="" type="radio"/> x
Nr. 12	- 28	05,49	80	17	30	6,0	4,9	4,60	<input checked="" type="radio"/> x	<input checked="" type="radio"/> x
1/4	- 28	06,35	80	17	30	7,0	5,5	5,50	<input checked="" type="radio"/> x	<input checked="" type="radio"/> x
5/16	- 24	07,94	90	18	35	8,0	6,2	6,90	<input checked="" type="radio"/> x	<input checked="" type="radio"/> x
3/8	- 24	09,53	100	20	39	10,0	8,0	8,50	<input checked="" type="radio"/> x	<input checked="" type="radio"/> x

x = ab Lager, Zwischenverkauf vorbehalten  
o = nur solange Lagervorrat vorhanden  
x = normally ex stock  
o = available while stocks last

\*\* SSP = Steilspirale  
\*\* SSP = quick spiral



UNF

Unified Feingewinde ANSI B 1.1

Baumaße DIN 2184 Teil 1, verstärkter Schaft

Unified Fine Threads ANSI B 1.1

Dimensions DIN 2184 part 1, Reinforced shank

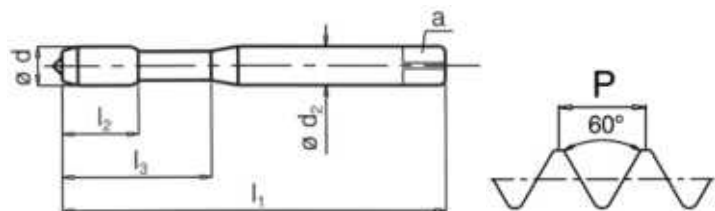

Katalog Nr. Bezeichnung	Catalogue No. Name	113 218 Spiralo 15	113 226 Spiralo 35	113 235 Spiralo 35 TiN	113 296 Spiralo 35 TiCN	113 253 Spiralo 48 TS TiN				
Toleranz	Tolerance	2B	2B	2B	2B	2B				
Anschnittform	Chamfer form	C	C	C	C	C				
Anschnittlänge, Gang	Chamfer length, threads	2-3	2-3	2-3	2-3	2-3				
für Bohrungsart	For holes									
Sonderwerkstoff	Special material					tiefe Sacklöcher 3xD deep blind holes 3xD				
Zerspanungsgruppe, siehe Ausklappseite links	Machinability-group, See folder left page	<input type="checkbox"/> P <input type="checkbox"/> <input type="checkbox"/> <input checked="" type="checkbox"/> N <input type="checkbox"/>	<input type="checkbox"/> P <input type="checkbox"/> <input type="checkbox"/> <input checked="" type="checkbox"/> N <input type="checkbox"/>	<input type="checkbox"/> P <input type="checkbox"/> <input type="checkbox"/> <input checked="" type="checkbox"/> N <input type="checkbox"/>	<input type="checkbox"/> P <input type="checkbox"/> <input type="checkbox"/> <input checked="" type="checkbox"/> N <input type="checkbox"/>	<input type="checkbox"/> P <input type="checkbox"/> <input type="checkbox"/> <input checked="" type="checkbox"/> N <input type="checkbox"/>				
Oberfläche	Surface			TiN	TiCN	TiN				
Ausführung	Variation									
Typenbeschreibung ab Seite	Type description from page	T2	T2	T2	T2	T2				
d	P	Ø	l <sub>1</sub>	l <sub>2</sub>	l <sub>2</sub>	l <sub>3</sub>	d <sub>2</sub>	a		Verfügbarkeit
	Gg/1"	mm			SSP**					Availability
Nr. 2	-	64	02,18	45	6	10	2,8	2,1	1,85	x
Nr. 3	-	56	02,52	50	9	14	2,8	2,1	2,15	x
Nr. 4	-	48	02,85	56	10	6	16	3,5	2,40	x
Nr. 5	-	44	03,18	56	10	6	18	3,5	2,70	x
Nr. 6	-	40	03,51	56	11	7	20	4,0	2,95	x
Nr. 8	-	36	04,17	63	13	8	21	4,5	3,4	3,50
Nr. 10	-	32	04,83	70	14	10	25	6,0	4,9	4,10
Nr. 12	-	28	05,49	80	17	10	30	6,0	4,9	4,60
1/4	-	28	06,35	80	17	12	30	7,0	5,5	5,50
5/16	-	24	07,94	90	18	12	35	8,0	6,2	6,90
3/8	-	24	09,53	100	20	14	39	10,0	8,0	8,50

x = ab Lager, Zwischenverkauf vorbehalten  
o = nur solange Lagervorrat vorhanden  
x = normally ex stock  
o = available while stocks last

\*\* SSP = Steilspirale  
\*\* SSP = quick spiral

UNF



	113 252 Spiralo 45	113 281 Gussfix	113 260 Nirofix	113 266 Nirofix TiN	113 269 Nirofix-Z STY/WC	113 263 Nirofix 35	113 267 Nirofix 35 TiN	113 268 Nirofix 48 STY/WC	
	2B C 2-3	2BX C 2-3	2B B 4-5	2B B 4-5	2BX B 4-5	2B C 2-3	2B C 2-3	2BX C 2-3	
	Aluminium 3.20 / 4.14	Grauguss Grey cast iron 2.11	1.9.4	1.9.4	rostfreie Stähle Stainless steels 1.9.5	1.9.4	1.9.4	1.9.5/3.2	
	<input type="checkbox"/> <input type="checkbox"/> <input type="checkbox"/> <input checked="" type="checkbox"/> N <input type="checkbox"/>	<input type="checkbox"/> <input type="checkbox"/> <input checked="" type="checkbox"/> K <input type="checkbox"/>	<input type="checkbox"/> <input checked="" type="checkbox"/> M <input type="checkbox"/> <input type="checkbox"/>	<input checked="" type="checkbox"/> P <input checked="" type="checkbox"/> M <input checked="" type="checkbox"/> K <input type="checkbox"/>	<input checked="" type="checkbox"/> P <input checked="" type="checkbox"/> M <input type="checkbox"/> <input checked="" type="checkbox"/> N <input type="checkbox"/>	<input type="checkbox"/> <input checked="" type="checkbox"/> M <input type="checkbox"/> <input type="checkbox"/>	<input checked="" type="checkbox"/> P <input checked="" type="checkbox"/> M <input checked="" type="checkbox"/> K <input type="checkbox"/>	<input checked="" type="checkbox"/> P <input checked="" type="checkbox"/> M <input type="checkbox"/> <input checked="" type="checkbox"/> N <input type="checkbox"/>	
		Nit	VAP	TiN	STY/WC	VAP	TiN	STY/WC	
	T2	T2	T2	T2	T2	T2	T2	T2	
d	P Gg/1"	Verfügbarkeit Availability							
Nr. 2 - 64									
Nr. 3 - 56									
Nr. 4 - 48									
Nr. 5 - 44									
Nr. 6 - 40	x	x	x	x		x			
Nr. 8 - 36	x	x	x	x		x	x		
Nr. 10 - 32	x	x	x	x	x	x	x	x	
Nr. 12 - 28	x	x	x	x		x			
1/4 - 28	x	x	x	x	x	x	x	x	
5/16 - 24	x	x	x	x	x	x	x	x	
3/8 - 24	x	x	x	x	x	x	x	x	

x = ab Lager, Zwischenverkauf vorbehalten  
o = nur solange Lagervorrat vorhanden  
x = normally ex stock  
o = available while stocks last

UNF

Unified Feingewinde ANSI B 1.1

Baumaße DIN 2184 Teil 1, verstärkter Schaft

Unified Fine Threads ANSI B 1.1

Dimensions DIN 2184 part 1, Reinforced shank

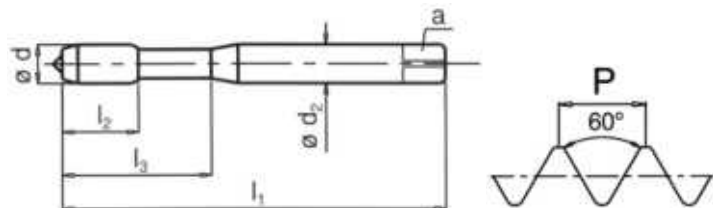

Katalog Nr. Bezeichnung	Catalogue No. Name	113 270 Dulofix VS	113 271 Spiralo 35 VS	113 256 Multifix	113 257 Multifix 35					
Toleranz	Tolerance	2B	2B	2B	2B					
Anschnittform	Chamfer form	B	C	B	C					
Anschnittlänge, Gang	Chamfer length, threads	4-5	2-3	4-5	2-3					
für Bohrungsart	For holes									
Sonderwerkstoff	Special material	Vergütungsstähle Heat-treatable steels 1.1.2/1.2.2/1.4.2/1.5.2/1.6.2/1.7		Werkzeugstähle Toolsteels 1.7 / 3.23						
Zerspanungsgruppe, siehe Ausklappseite links	Machinability-group, See folder left page	<input type="checkbox"/> P <input type="checkbox"/> <input type="checkbox"/> <input type="checkbox"/> <input type="checkbox"/> <input type="checkbox"/>	<input type="checkbox"/> P <input type="checkbox"/> <input type="checkbox"/> <input type="checkbox"/> <input type="checkbox"/> <input type="checkbox"/>	<input type="checkbox"/> P <input type="checkbox"/> <input type="checkbox"/> <input type="checkbox"/> <input type="checkbox"/> <input type="checkbox"/> <input type="checkbox"/> <input type="checkbox"/> <input type="checkbox"/> <input type="checkbox"/>	<input type="checkbox"/> P <input type="checkbox"/> <input type="checkbox"/> <input type="checkbox"/> <input type="checkbox"/> <input type="checkbox"/> <input type="checkbox"/> <input type="checkbox"/> <input type="checkbox"/> <input type="checkbox"/>					
Oberfläche	Surface			Stygian	Stygian					
Ausführung	Variation									
Typenbeschreibung ab Seite	Type description from page	T2	T2	T2	T2					
d	P Gg/1"	Ø mm	l <sub>1</sub>	l <sub>2</sub>	l <sub>2</sub> SSP**	l <sub>3</sub>	d <sub>2</sub>	a		Verfügbarkeit Availability
Nr. 2	- 64	02,18	45	6		10	2,8	2,1	1,85	
Nr. 3	- 56	02,52	50	9		14	2,8	2,1	2,15	
Nr. 4	- 48	02,85	56	10	6	16	3,5	2,7	2,40	
Nr. 5	- 44	03,18	56	10	6	18	3,5	2,7	2,70	
Nr. 6	- 40	03,51	56	11	7	20	4,0	3,0	2,95	x
Nr. 8	- 36	04,17	63	13	8	21	4,5	3,4	3,50	x
Nr. 10	- 32	04,83	70	14	10	25	6,0	4,9	4,10	x
Nr. 12	- 28	05,49	80	17	10	30	6,0	4,9	4,60	
1/4	- 28	06,35	80	17	12	30	7,0	5,5	5,50	x
5/16	- 24	07,94	90	18	12	35	8,0	6,2	6,90	x
3/8	- 24	09,53	100	20	14	39	10,0	8,0	8,50	x

x = ab Lager, Zwischenverkauf vorbehalten  
o = nur solange Lagervorrat vorhanden  
x = normally ex stock  
o = available while stocks last

\*\* SSP = Steilspirale  
\*\* SSP = quick spiral

UNF



	113 273 Dulofix HF	113 292 Dulofix HF TiCN	113 274 Spiralo 35 HF	113 293 Spir.35 HF TiCN	113 276 Dulofix Ni	113 277 Spiralo 25 Ni	113 278 Dulofix Ti	113 279 Spiralo 25 Tii	
	2B B 4-5	2B B 4-5	2B C 2-3	2B C 2-3	2B B 5	2B C 3	2B B 5	2B C 3	
	hochfeste Stähle Hard materials 1.4.3 / 1.5.3 / 1.6.3 / 1.8				Nickellegierungen Nickel alloys 5.25		Titanlegierungen Titanium alloys 5.26		
	<input type="checkbox"/> P	<input type="checkbox"/> P	<input type="checkbox"/> P	<input type="checkbox"/> P	<input type="checkbox"/> S	<input type="checkbox"/> S	<input type="checkbox"/> S	<input type="checkbox"/> S	
		TiCN		TiCN			Nit	Nit	
	T2	T2	T2	T2	T2	T2	T2	T2	
d	P Gg/1"	Verfügbarkeit Availability							
Nr. 2 - 64									
Nr. 3 - 56									
Nr. 4 - 48									
Nr. 5 - 44									
Nr. 6 - 40	x	x	x	x	x	x	x	x	
Nr. 8 - 36	x	x	x	x	x	x	x	x	
Nr. 10 - 32	x	x	x	x	x	x	x	x	
Nr. 12 - 28									
1/4 - 28	x	x	x	x	x	x	x	x	
5/16 - 24	x	x	x	x	x	x	x	x	
3/8 - 24	x	x	x	x	x	x	x	x	

x = ab Lager, Zwischenverkauf vorbehalten  
o = nur solange Lagervorrat vorhanden  
x = normally ex stock  
o = available while stocks last

UNF

Unified Feingewinde ANSI B 1.1

Baumaße DIN 2184 Teil 1, Überlaufschaff

Unified Fine Threads ANSI B 1.1

Dimensions DIN 2184 part 1, Reduced shank

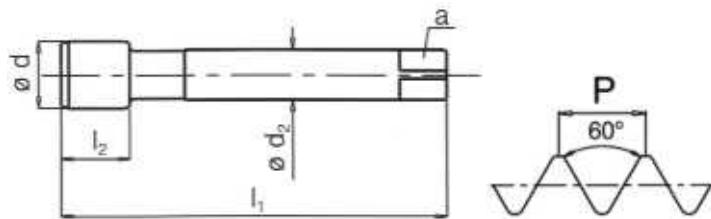

Katalog Nr. Bezeichnung	Catalogue No. Name	113 300 Hahnreiter	113 305 Dulofix	113 310 Dulofix TiN	113 395 Dulofix TiCN	113 318 Spiralo 15			
Toleranz	Tolerance	2B	2B	2B	2B	2B			
Anschnittform	Chamfer form	C	B	B	B	C			
Anschnittlänge, Gang	Chamfer length, threads	2-3	4-5	4-5	4-5	2-3			
für Bohrungsart	For holes								
Sonderwerkstoff	Special material								
Zerspanungsgruppe, siehe Ausklappseite links	Machinability-group, See folder left page	<input type="checkbox"/> P <input type="checkbox"/> <input type="checkbox"/> <input type="checkbox"/>	<input type="checkbox"/> P <input type="checkbox"/> <input type="checkbox"/> <input checked="" type="checkbox"/> N <input type="checkbox"/>	<input type="checkbox"/> P <input type="checkbox"/> <input type="checkbox"/> <input checked="" type="checkbox"/> N <input type="checkbox"/>	<input type="checkbox"/> P <input type="checkbox"/> <input type="checkbox"/> <input checked="" type="checkbox"/> N <input type="checkbox"/>	<input type="checkbox"/> P <input type="checkbox"/> <input type="checkbox"/> <input checked="" type="checkbox"/> N <input type="checkbox"/>			
Oberfläche	Surface			TiN	TiCN				
Ausführung	Variation								
Typenbeschreibung ab Seite	Type description from page	T2	T2	T2	T2	T2			
d	P Gg/1"	Ø mm	l <sub>1</sub>	l <sub>2</sub>	l <sub>2</sub> SSP**	d <sub>2</sub>	a		Verfügbarkeit Availability
3/8	- 24	09,53	90	17	14	7,0	5,5	8,50	<b>o</b>
7/16	- 20	11,11	100	22	18	8,0	6,2	9,90	<b>x</b>
1/2	- 20	12,70	100	20	16	9,0	7,0	11,50	<b>x</b>
9/16	- 18	14,29	100	20		11,0	9,0	12,90	<b>x</b>
5/8	- 18	15,88	100	22	16	12,0	9,0	14,50	<b>x</b>
3/4	- 16	19,05	110	25	20	14,0	11,0	17,50	<b>x</b>
7/8	- 14	22,23	125	25		18,0	14,5	20,40	<b>x</b>
1	- 12	25,40	140	28		18,0	14,5	23,25	<b>x</b>
1.1/8	- 12	28,58	150	28	22	22,0	18,0	26,50	<b>x</b>
1.1/4	- 12	31,75	150	28	22	22,0	18,0	29,50	<b>x</b>
1.3/8	- 12	34,93	170	28		28,0	22,0	32,75	<b>x</b>
1.1/2	- 12	38,10	170	28		28,0*	22,0	36,00	<b>x</b>

**x** = ab Lager, Zwischenverkauf vorbehalten  
**o** = nur solange Lagervorrat vorhanden  
*x* = normally ex stock  
*o* = available while stocks last

\*\* SSP = Steilspirale  
 \*\* SSP = quick spiral

UNF

HSS-EP



UNF

	113 326 Spiralo 35	113 335 Spiralo 35 TiN	113 396 Spiralo 35 TiCN	113 353 Spiralo 48 TS TiN	113 352 Spiralo 45	113 381 Gussfix	113 360 Nirofix	113 366 Nirofix TiN	113 369 Nirofix-Z STY/WC
	2B C 2-3	2B C 2-3	2B C 2-3	2B C 2-3	2B C 2-3	2BX C 2-3	2B B 4-5	2B B 4-5	2BX B 4-5
					Aluminium 3.20 / 4.14	Grauguss Grey cast iron 2.11	rostfreie Stähle Stainless steels 1.9.4		1.9.5 / 3.2
	<input type="checkbox"/> P <input type="checkbox"/> <input type="checkbox"/> <input type="checkbox"/> N <input type="checkbox"/>	<input type="checkbox"/> P <input type="checkbox"/> <input type="checkbox"/> <input type="checkbox"/> N <input type="checkbox"/>	<input type="checkbox"/> P <input type="checkbox"/> <input type="checkbox"/> <input type="checkbox"/> <input type="checkbox"/> <input type="checkbox"/>	<input type="checkbox"/> P <input type="checkbox"/> <input type="checkbox"/> <input type="checkbox"/> <input type="checkbox"/> <input type="checkbox"/>	<input type="checkbox"/> <input type="checkbox"/> <input type="checkbox"/> <input type="checkbox"/> <input type="checkbox"/> N <input type="checkbox"/>	<input type="checkbox"/> <input type="checkbox"/> <input type="checkbox"/> <input type="checkbox"/> <input type="checkbox"/> K <input type="checkbox"/>	<input type="checkbox"/> <input type="checkbox"/> <input type="checkbox"/> <input type="checkbox"/> <input type="checkbox"/> M <input type="checkbox"/> <input type="checkbox"/> <input type="checkbox"/>	<input type="checkbox"/> P <input type="checkbox"/> M <input type="checkbox"/> K <input type="checkbox"/> <input type="checkbox"/> <input type="checkbox"/> <input type="checkbox"/>	<input type="checkbox"/> P <input type="checkbox"/> M <input type="checkbox"/> N <input type="checkbox"/> <input type="checkbox"/>
		TiN	TiCN	TiN		Nit	VAP	TiN	STY/WC
	T2	T2	T2	T2	T2	T2	T2	T2	T2
d	P Gg/1"	Verfügbarkeit Availability							
3/8 - 24	x								
7/16 - 20	x	x	x	x	x	x	x	x	x
1/2 - 20	x	x	x	x	x	x	x	x	x
9/16 - 18	x	x					x	x	x
5/8 - 18	x	x	x	x		x	x	x	x
3/4 - 16	x	x	x	x		x	x	x	x
7/8 - 14	x	x				x	x	x	
1 - 12	x	x				x	x	x	
1.1/8 - 12	x								
1.1/4 - 12	x								
1.3/8 - 12	x								
1.1/2 - 12	x								

x = ab Lager, Zwischenverkauf vorbehalten  
o = nur solange Lagervorrat vorhanden  
x = normally ex stock  
o = available while stocks last



UNF

Unified Feingewinde ANSI B 1.1

Baumaße DIN 2184 Teil 1, Überlaufschaff

Unified Fine Threads ANSI B 1.1

Dimensions DIN 2184 part 1, Reduced shank

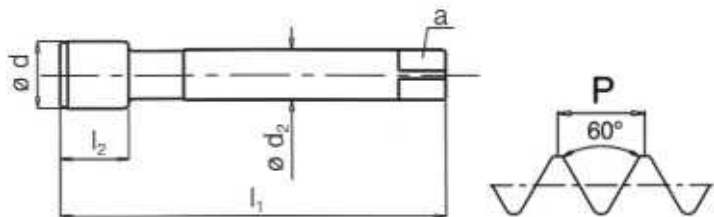

HSS-EP



Katalog Nr. Bezeichnung	Catalogue No. Name	113 363 Nirofix 35	113 367 Nirofix 35 TiN	113 368 Nirofix 48 STY/WC	113 370 Dulofix VS	113 371 Spiralo 35 VS								
Toleranz	Tolerance	2B	2B	2BX	2B	2B								
Anschnittform	Chamfer form	C	C	C	B	C								
Anschnittlänge, Gang	Chamfer length, threads	2-3	2-3	2-3	4-5	2-3								
für Bohrungsart	For holes													
Sonderwerkstoff	Special material	rostfreie Stähle Stainless steels			Vergütungsstähle Heat-treatable steels									
Zerspanungsgruppe, siehe Ausklappseite links	Machinability-group, See folder left page	1.9.4	1.9.4	1.9.5 / 3.2										
Oberfläche	Surface	VAP	TiN	STY/WC										
Ausführung	Variation													
Typenbeschreibung ab Seite	Type description from page	T2	T2	T2	T2	T2								
d	P	Ø	l <sub>1</sub>	l <sub>2</sub>	l <sub>2</sub>	d <sub>2</sub>	a	Verfügbarkeit Availability						
	Gg/1"	mm			SSP**									
3/8	- 24	09,53	90	17	14	7,0	5,5	8,50						
7/16	- 20	11,11	100	22	18	8,0	6,2	9,90	x					x
1/2	- 20	12,70	100	20	16	9,0	7,0	11,50	x	x				x
9/16	- 18	14,29	100	20		11,0	9,0	12,90	x	x	x			x
5/8	- 18	15,88	100	22	16	12,0	9,0	14,50	x	x	x			x
3/4	- 16	19,05	110	25	20	14,0	11,0	17,50	x	x	x			x
7/8	- 14	22,23	125	25		18,0	14,5	20,40	x	x				x
1	- 12	25,40	140	28		18,0	14,5	23,25	x	x				x
1.1/8	- 12	28,58	150	28	22	22,0	18,0	26,50						
1.1/4	- 12	31,75	150	28	22	22,0	18,0	29,50						
1.3/8	- 12	34,93	170	28		28,0	22,0	32,75						
1.1/2	- 12	38,10	170	28		28,0	22,0	36,00						

x = ab Lager, Zwischenverkauf vorbehalten  
o = nur solange Lagervorrat vorhanden  
x = normally ex stock  
o = available while stocks last

\*\* SSP = Steilspirale  
\*\* SSP = quick spiral

# Maschinen-Gewindebohrer

## Machine Taps

# HAHNREITER HSS-E / HSS-EP\*

\* Pulvermetallurgisch erzeugter Schnellstahl / Made from powder metallurgy material

## UNF



		113 356 Multifix	113 357 Multifix 35	113 373 Dulofix HF	113 392 Dulo. HF TiCN	113 374 Spiralo 35 HF	113 393 Spir.35 HF TiCN	113 376 Dulofix Ni	113 377 Spiralo 25 Ni
		2B B 4-5	2B C 2-3	2B B 4-5	2B B 4-5	2B C 2-3	2B C 2-3	2B B 5	2B C 3
		Werkzeugstähle Toolsteels 1.7 / 3.23			hochfeste Stähle Hard materials 1.4.3/1.5.3 / 1.6.3/1.8			Nickellegierungen Nickel alloys 5.25	
		<input type="checkbox"/> P <input type="checkbox"/> <input type="checkbox"/> <input type="checkbox"/> <input type="checkbox"/> <input type="checkbox"/> <input type="checkbox"/> <input type="checkbox"/> <input type="checkbox"/> <input type="checkbox"/> <input type="checkbox"/>	<input type="checkbox"/> P <input type="checkbox"/> <input type="checkbox"/> <input type="checkbox"/> <input type="checkbox"/> <input type="checkbox"/> <input type="checkbox"/> <input type="checkbox"/> <input type="checkbox"/> <input type="checkbox"/>	<input type="checkbox"/> P <input type="checkbox"/> <input type="checkbox"/> <input type="checkbox"/> <input type="checkbox"/> <input type="checkbox"/> <input type="checkbox"/> <input type="checkbox"/> <input type="checkbox"/> <input type="checkbox"/>	<input type="checkbox"/> P <input type="checkbox"/> <input type="checkbox"/> <input type="checkbox"/> <input type="checkbox"/> <input type="checkbox"/> <input type="checkbox"/> <input type="checkbox"/> <input type="checkbox"/> <input type="checkbox"/>	<input type="checkbox"/> P <input type="checkbox"/> <input type="checkbox"/> <input type="checkbox"/> <input type="checkbox"/> <input type="checkbox"/> <input type="checkbox"/> <input type="checkbox"/> <input type="checkbox"/> <input type="checkbox"/>	<input type="checkbox"/> <input type="checkbox"/> <input type="checkbox"/> <input type="checkbox"/> <input type="checkbox"/> <input type="checkbox"/> <input type="checkbox"/> <input type="checkbox"/> <input type="checkbox"/>	<input type="checkbox"/> <input type="checkbox"/> <input type="checkbox"/> <input type="checkbox"/> <input type="checkbox"/> <input type="checkbox"/> <input type="checkbox"/> <input type="checkbox"/> <input type="checkbox"/>	<input type="checkbox"/> <input type="checkbox"/> <input type="checkbox"/> <input type="checkbox"/> <input type="checkbox"/> <input type="checkbox"/> <input type="checkbox"/> <input type="checkbox"/> <input type="checkbox"/>
		Stygian	Stygian		TiCN		TiCN		
		T2	T2	T2	T2	T2	T2	T2	T2
d	P Gg/1"	Verfügbarkeit Availability							
3/8	- 24								
7/16	- 20	x	x	x	x	x	x	x	x
1/2	- 20	x	x	x	x	x	x	x	x
9/16	- 18	x	x						
5/8	- 18	x	x						
3/4	- 16	x	x						
7/8	- 14								
1	- 12								
1.1/8	- 12								
1.1/4	- 12								
1.3/8	- 12								
1.1/2	- 12								

x = ab Lager, Zwischenverkauf vorbehalten  
o = nur solange Lagervorrat vorhanden  
x = normally ex stock  
o = available while stocks last

UNF

Unified Gewinde 8 Gang Reihe ANSI B 1.1

Baumaße DIN 2184 Teil 1

Unified Threads 8 TPI Series ANSI B 1.1

Dimensions DIN 2184 part 1

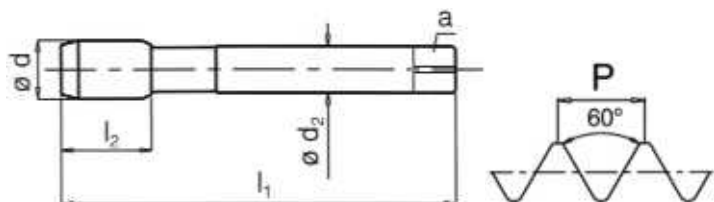

UNF

Katalog Nr. Bezeichnung	Catalogue No. Name	113 245 Drückfix N TiN	113 345 DrückfixN TiN							
Toleranz	Tolerance	2BX	2BX							
Anschnittform	Chamfer form	C	C							
Anschnittlänge, Gang	Chamfer length, threads	2-3	2-3							
für Bohrungsart	For holes									
Sonderwerkstoff	Special material	Werkstoffe mit min. 10% Bruchdehnung Materials with elongation of min. 10%								
Zerspanungsgruppe, siehe Ausklappseite links	Machinability-group, See folder left page	<input type="checkbox"/> P <input type="checkbox"/> M <input type="checkbox"/> N <input type="checkbox"/>	<input type="checkbox"/> P <input type="checkbox"/> M <input type="checkbox"/> N <input type="checkbox"/>							
Oberfläche	Surface	TiN	TiN							
Ausführung	Variation									
Typenbeschreibung ab Seite	Type description from page	T2	T2							
d	P Gg/1"	Ø mm	l <sub>1</sub>	l <sub>2</sub>	l <sub>2</sub> SSP**	l <sub>3</sub>	d <sub>2</sub>	a		Verfügbarkeit Availability
Nr. 2	- 64	02,18								
Nr. 3	- 56	02,52								
Nr. 4	- 48	02,85	56	10	6	16	3,5	2,7	2,60	x
Nr. 5	- 44	03,18	56	10	6	18	3,5	2,7	2,90	x
Nr. 6	- 40	03,51	56	11	7	20	4,0	3,0	3,20	x
Nr. 8	- 36	04,17	63	12	8	21	4,5	3,4	3,85	x
Nr. 10	- 32	04,83	70	14	10	25	6,0	4,9	4,45	x
Nr. 12	- 28	05,49	80	16	10	30	6,0	4,9	5,10	x
1/4	- 28	06,35	80	16	12	30	7,0	5,5	5,95	x
5/16	- 24	07,94	90	18	12	35	8,0	6,2	7,45	x
3/8	- 24	09,53	100	18	14	39	10,0	8,0	9,05	x
7/16	- 20	11,11	100	22			8,0	6,2	10,55	
1/2	- 20	12,70	100	20			9,0	7,0	12,10	x
9/16	- 18	14,29	100	22			11,0	9,0	13,65	x
5/8	- 18	15,88	100	22			12,0	9,0	15,25	x
3/4	- 16	19,05	110	25			14,0	11,0	18,35	x

x = ab Lager, Zwischenverkauf vorbehalten  
o = nur solange Lagervorrat vorhanden  
x = normally ex stock  
o = available while stocks last

\*\* SSP = Steilschneidspiral  
\*\* SSP = quick spiral

**EG-UNF**

**Unified Feingewinde für Draht-Gewindeeinsätze NASM 33537**

Baumaße DIN 2184 Teil 1, verstärkter Schaft,  $\geq 3/8''$  Überlaufschaft

**Unified Fine Threads for wire inserts NASM 33537**

Dimensions DIN 2184 part 1, Reinforced shank,  $\geq 3/8''$  Reduced shank

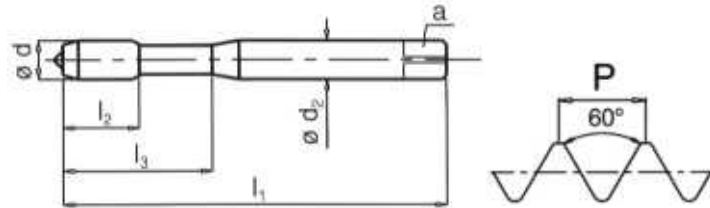

Katalog Nr. Bezeichnung	Catalogue No. Name		136 205 Dulofix	136 226 Spiralo 35	136 252 Spiralo 45		
Toleranz	Tolerance		2B	2B	2B		
Anschnittform	Chamfer form		B	C	C		
Anschnittlänge, Gang	Chamfer length, threads		4-5	2-3	2-3		
für Bohrungsart	For holes						
Sonderwerkstoff	Special material				Aluminium 3.20 / 4.14		
Zerspanungsgruppe, siehe Ausklappseite links	Machinability-group, See folder left page		<input type="checkbox"/> P <input type="checkbox"/> <input type="checkbox"/> <input type="checkbox"/> <input checked="" type="checkbox"/> N <input type="checkbox"/> <input type="checkbox"/>	<input type="checkbox"/> P <input type="checkbox"/> <input type="checkbox"/> <input type="checkbox"/> <input checked="" type="checkbox"/> N <input type="checkbox"/> <input type="checkbox"/>	<input type="checkbox"/> <input type="checkbox"/> <input type="checkbox"/> <input type="checkbox"/> <input checked="" type="checkbox"/> N <input type="checkbox"/> <input type="checkbox"/>		
Oberfläche	Surface						
Ausführung	Variation				2 Nuten 2 Flutes		
Typenbeschreibung ab Seite	Type description from page		T2	T2	T2		
d	P	Code	Verfügbarkeit				
Gg/1"	mm	mm	Availability				
		SSP**					
EG Nr. 10 - 32	04,83	80 17 10 30 6,0 4,9 5,10	x	x	x		
EG 1/4 - 28	06,35	90 18 12 35 8,0 6,2 6,60	x	x	x		
EG 5/16 - 24	07,94	100 20 14 39 10,0 8,0 8,25	x	x	x		

$\geq 3/8''$  Überlaufschaft  
 $\geq 3/8''$  reduced shank

Katalog Nr. Bezeichnung	Catalogue No. Name		136 305 Dulofix	136 326 Spiralo 35	136 352 Spiralo 45	
Toleranz	Tolerance		2B	2B	2B	
EG 3/8 - 24	09,53	100 15 12 8,0 6,2 9,80	x	x	x	
EG 1/2 - 20	12,70	100 22 20 11,0 9,0 13,10	x	x	x	

x = ab Lager, Zwischenverkauf vorbehalten  
o = nur solange Lagervorrat vorhanden  
x = normally ex stock  
o = available while stocks last

\*\* SSP = Steilspirale  
\*\* SSP = quick spiral



G

**Whitworth Rohrgewinde DIN ISO 228**  
Baumaße DIN 5157, Satz à 2 Stück  
**Whitworth Pipe Threads DIN ISO 228**  
Dimensions DIN 5157, Set of 2 pieces

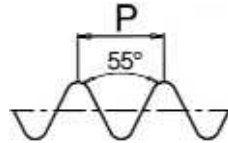
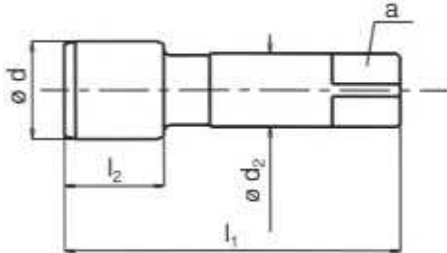

Katalog Nr. Bezeichnung	Catalogue No. Name	114 061 Hahnreiter	114 062 Hahnreiter	114 060 Hahnreiter							
Toleranz	Tolerance	Nr. 1									
Anschnittform	Chamfer form		C								
Anschnittlänge, Gang	Chamfer length, threads	5	2-3								
für Bohrungsart	For holes										
hauptsächlich Einsatzgebiet	Main use	alle gut spanbaren Materialien bis 800 N/mm <sup>2</sup> all free machining materials up to 800 N/mm <sup>2</sup>									
Zerspanungsgruppe, siehe Ausklappseite links	Machinability-group, See folder left page										
Ausführung	Variation	Vorschneider Taper	Fertigschneider Bottoming	Satz à 2 Stück Set of 2 pc.							
Oberfläche	Surface	Verfügbarkeit Availability									
d	P Gg/1"	Ø mm	l <sub>1</sub>	l <sub>2</sub>	d <sub>2</sub>	a					
G 1/8	28	09,73	63	16	7,0	5,5	8,80	x	x		x
G 1/4	19	13,16	70	20	11,0	9,0	11,80	x	x		x
G 3/8	19	16,66	70	20	12,0	9,0	15,25	x	x		x
G 1/2	14	20,96	80	22	16,0	12,0	19,00	x	x		x
G 5/8	14	22,91	80	22	18,0	14,5	21,00	x	x		x
G 3/4	14	26,44	90	22	20,0	16,0	24,50	x	x		x
G 7/8	14	30,20	90	22	22,0	18,0	28,25	x	x		x
G 1	11	33,25	100	25	25,0	20,0	30,75	x	x		x
G 1.1/8	11	37,90	125	30	28,0	22,0	35,50	x	x		x
G 1.1/4	11	41,91	125	30	32,0	24,0	39,50	x	x		x
G 1.1/2	11	47,80	140	30	36,0	29,0	45,25	x	x		x
G 1.3/4	11	53,75	140	40	40,0	32,0	51,10	x	x		x
G 2	11	59,61	160	40	45,0	35,0	57,00	x	x		x
G 2.1/4	11	65,71	160	40	50,0	32,0	63,10	x	x		x
G 2.1/2	11	75,18	160	40	50,0	39,0	72,50	x	x		x
G 2.3/4	11	81,53	160	40	50,0	39,0	79,00	x	x		x
G 3	11	87,88	160	40	50,0	39,0	85,50	x	x		x
G 4	11	113,00	180	40	56,0	44,0	110,50	x	x		x

Technische Informationen zum Thema Rohrgewinde siehe Seite T20  
For technical information concerning pipe threads, please see page T22

x = ab Lager, Zwischenverkauf vorbehalten  
o = nur solange Lagerinventar vorhanden  
x = normally ex stock  
o = available while stocks last



G

Whitworth Rohrgewinde DIN ISO 228

Baumaße Werksnorm

Whitworth Pipe Threads DIN ISO 228

Dimensions manufacturer's standard

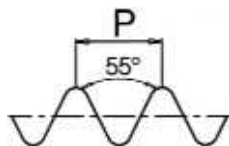
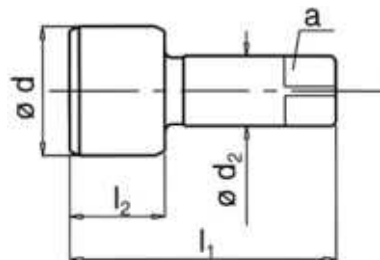

Katalog Nr. Bezeichnung	Catalogue No. Name	114 600 Automat MS	114 601 Automat MS +0,05	114 602 Automat MS +0,1	114 605 Automat 15	114 606 Automat 15 +0,05						
Toleranz	Tolerance	E	+0,05	+0,1	E	+0,05						
Anschnittform	Chamfer form	E	E	E	E	E						
Anschnittlänge, Gang	Chamfer length, threads	1,5-2	1,5-2	1,5-2	1,5-2	1,5-2						
für Bohrungsart	For holes											
Sonderwerkstoff	Special material	Messing Brass 3.21			Automatenstahl free cutting steel 1.2							
Zerspanungsgruppe, siehe Ausklappseite links	Machinability-group, See folder left page	<input type="checkbox"/>	<input type="checkbox"/>	<input type="checkbox"/>	<input type="checkbox"/>	<input type="checkbox"/>						
Oberfläche	Surface				VAP	VAP						
Ausführung	Variation		Aufmaß Oversize	Aufmaß Oversize		Aufmaß Oversize						
Typenbeschreibung ab Seite	Type description from page	T2	T2	T2	T2	T2						
d	P	Ø	l <sub>1</sub>	l <sub>2</sub>	d <sub>2</sub>	a	Verfügbarkeit Availability					
	Gg/1"	mm										
G 1/8	28	09,73	70	20	8,0	6,2	8,80	x	x	x	x	x
G 1/4	19	13,16	70	20	10,0	8,0	11,80	x	x	x	x	x
G 3/8	19	16,66	70	20	12,0	9,0	15,25	x	x	x	x	x
G 1/2	14	20,96	70	22	16,0 (15,0)*	12,0	19,00	x	x	x	x	x
G 5/8	14	22,91	70	22	18,0	14,5	21,00	x	x	x	x	x
G 3/4	14	26,44	70	24	18,0	14,5	24,50	x	x	x	x	x
G 7/8	14	30,20	70	24	18,0	14,5	28,25	x	x	x	x	x
G 1	11	33,25	70	25	18,0	14,5	30,75	x	x	x	x	x
G 1.1/8	11	37,90	70	25	18,0	14,5	35,50	x	x	x	x	x
G 1.1/4	11	41,91	70	25	18,0	14,5	39,50	x	x	x	x	x
G 1.1/2	11	47,80	70	25	18,0	14,5	45,25	x	x	x	x	x

Weitere Abmessungen und Aufmaße ab Lager verfügbar. Bitte anfragen.  
Other sizes and oversizes ex stock available on request.

Technische Informationen zum Thema Rohrgewinde siehe Seite T20  
For technical information concerning pipe threads, please see page T22

\*solange Lagervorrat liefern wir mit Schaft Ø 15,0  
\*as long as available we will send shank Ø 15,0

x = ab Lager, Zwischenverkauf vorbehalten  
o = nur solange Lagervorrat vorhanden  
x = normally ex stock  
o = available while stocks last

G



		114 619 Automat 20 MS-Z	114 611 Automat 20 +0,05 MS-Z	114 612 Automat 20+0,1 MS-Z	114 616 Automat 20 Sty	114 617 Automat 20 +0,05 Sty	114 618 Automat 20+0,1 Sty	114 607 Automat 20	114 608 Automat 20 +0,05	114 609 Automat 20+0,1
		E 1,5-2	+0,05 E 1,5-2	+0,1 E 1,5-2	E 1,5-2	+0,05 E 1,5-2	+0,1 E 1,5-2	E 1,5-2	+0,05 E 1,5-2	+0,1 E 1,5-2
		Messing, bleifrei, bleireduziert Brass, leadfree, reduced lead 3.22			Cu-Sonderlegierungen bleifrei, bleireduziert Special copper alloys, leadfree, low-leaded 3.21/3.22			Automatenstahl free cutting steel 1.2		
		<input type="checkbox"/>	<input type="checkbox"/>	<input type="checkbox"/>	<input type="checkbox"/>	<input type="checkbox"/>	<input type="checkbox"/>	<input type="checkbox"/>	<input type="checkbox"/>	<input type="checkbox"/>
					Stygian	Stygian	Stygian	VAP	VAP	VAP
			Aufmaß Oversize	Aufmaß Oversize		Aufmaß Oversize	Aufmaß Oversize		Aufmaß Oversize	Aufmaß Oversize
		T2	T2	T2	T2	T2	T2	T2	T2	T2
d	P Gg/1"	Verfügbarkeit Availability								
G 1/8	28	x	x	x	x	x	x	x	x	x
G 1/4	19	x	x	x	x	x	x	x	x	x
G 3/8	19	x	x	x	x	x	x	x	x	x
G 1/2	14	x	x	x	x	x	x	x	x	x
G 5/8	14									
G 3/4	14	x	x	x	x	x	x	x	x	x
G 7/8	14									
G 1	11	x	x	x	x	x	x	x	x	x
G 1.1/8	11									
G 1.1/4	11									
G 1.1/2	11									

x = ab Lager, Zwischenverkauf vorbehalten  
o = nur solange Lagervorrat vorhanden  
x = normally ex stock  
o = available while stocks last

G

Whitworth Rohrgewinde DIN ISO 228

Baumaße Werksnorm

Whitworth Pipe Threads DIN ISO 228

Dimensions manufacturer's standard

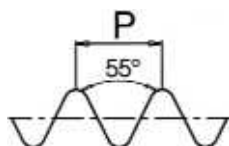
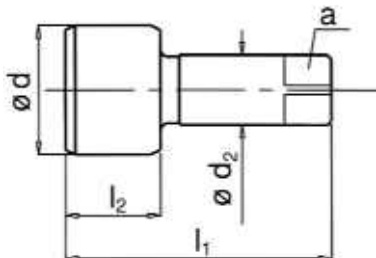

Katalog Nr. Bezeichnung	Catalogue No. Name	114 613 Automat 20 TiN	114 614 Automat 20+0,05 TiN	114 615 Automat 20+0,1 TiN				
Toleranz	Tolerance	E	+0,05	+0,1				
Anschnittform	Chamfer form	E	E	E				
Anschnittlänge, Gang	Chamfer length, threads	1,5-2	1,5-2	1,5-2				
für Bohrungsart	For holes							
Sonderwerkstoff	Special material	rostfreie Stähle Stainless steels 1.9.4. / 1.9.5.						
Zerspanungsgruppe, siehe Ausklappseite links	Machinability-group, See folder left page	<input type="checkbox"/> M <input type="checkbox"/>	<input type="checkbox"/> M <input type="checkbox"/>	<input type="checkbox"/> M <input type="checkbox"/>				
Oberfläche	Surface	TiN	TiN	TiN				
Ausführung	Variation		Aufmaß Oversize	Aufmaß Oversize				
Typenbeschreibung ab Seite	Type description from page	T2	T2	T2				
d	P Gg/1"	Ø mm	l <sub>1</sub>	l <sub>2</sub>	d <sub>2</sub>	a		Verfügbarkeit Availability
G 1/8	28	09,73	70	20	8,0	6,2	8,80	x
G 1/4	19	13,16	70	20	10,0	8,0	11,80	x
G 3/8	19	16,66	70	20	12,0	9,0	15,25	x
G 1/2	14	20,96	70	22	16,0 (15,0)*	8,0	19,00	x
G 5/8	14	22,91	70	22	18,0	12,0	21,00	
G 3/4	14	26,44	70	24	18,0	14,5	24,50	x
G 7/8	14	30,20	70	24	18,0	14,5	28,25	
G 1	11	33,25	70	25	18,0	14,5	30,75	x
G 1 1/8	11	37,90	70	25	18,0	14,5	35,50	
G 1 1/4	11	41,91	70	25	18,0	14,5	39,50	
G 1 1/2	11	47,80	70	25	18,0	14,5	45,25	

Technische Informationen zum Thema Rohrgewinde siehe Seite T20  
For technical information concerning pipe threads, please see page T22

x = ab Lager, Zwischenverkauf vorbehalten  
o = nur solange Lagervorrat vorhanden  
x = normally ex stock  
o = available while stocks last

\*solange Lagervorrat liefern wir mit Schaft Ø 15,0  
\*as long as available we will send shank Ø 15,0

**G**

**Whitworth Rohrgewinde DIN ISO 228**  
Baumaße DIN 5157, kurze Ausführung  
**Whitworth Pipe Threads DIN ISO 228**  
Dimensions DIN 5157, Short Taps

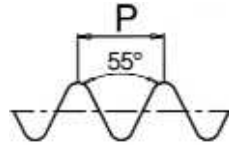
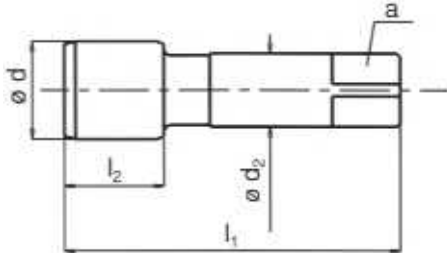

Katalog Nr. Bezeichnung	Catalogue No. Name	114 105 Dulofix	114 118 Spiralo 15	114 180 Hahnreiter MS	114 184 Hahn. MS +0,05	114 187 Hahn. MS +0,1		
Toleranz	Tolerance	B	C	E	+0,05	+0,1		
Anschnittform	Chamfer form	4-5	2-3	E	E	E		
Anschnittlänge, Gang	Chamfer length, threads			1,5-2	1,5-2	1,5-2		
für Bohrungsart	For holes							
Sonderwerkstoff	Special material			Messing Brass 3.21				
Zerspanungsgruppe, siehe Ausklappseite links	Machinability-group, See folder left page	<input type="checkbox"/> P <input type="checkbox"/> <input type="checkbox"/> <input type="checkbox"/> <input type="checkbox"/> <input type="checkbox"/>	<input type="checkbox"/> P <input type="checkbox"/> <input type="checkbox"/> <input type="checkbox"/> <input type="checkbox"/> <input type="checkbox"/>	<input type="checkbox"/> <input type="checkbox"/> <input type="checkbox"/> <input checked="" type="checkbox"/> N <input type="checkbox"/> <input type="checkbox"/> <input type="checkbox"/>	<input type="checkbox"/> <input type="checkbox"/> <input type="checkbox"/> <input checked="" type="checkbox"/> N <input type="checkbox"/> <input type="checkbox"/> <input type="checkbox"/>	<input type="checkbox"/> <input type="checkbox"/> <input type="checkbox"/> <input checked="" type="checkbox"/> N <input type="checkbox"/> <input type="checkbox"/> <input type="checkbox"/>		
Oberfläche	Surface							
Ausführung	Variation				Aufmaß Oversize	Aufmaß Oversize		
Typenbeschreibung ab Seite	Type description from page	T2	T2	T2	T2	T2		
d	P	Ø	l <sub>1</sub>	l <sub>2</sub>	d <sub>2</sub>	a	Verfügbarkeit Availability	
	Gg/1"	mm						
G 1/8	28	09,73	63	16	7,0	5,5	8,80	
G 1/4	19	13,16	70	20	11,0	9,0	11,80	o
G 3/8	19	16,66	70	20	12,0	9,0	15,25	o
G 1/2	14	20,96	80	22	16,0	12,0	19,00	o
G 5/8	14	22,91	80	22	18,0	14,5	21,00	o
G 3/4	14	26,44	90	22	20,0	16,0	24,50	o
G 7/8	14	30,20	90	22	22,0	18,0	28,25	
G 1	11	33,25	100	25	25,0	20,0	30,75	
G 1.1/8	11	37,90	125	30	28,0	22,0	35,50	
G 1.1/4	11	41,91	125	30	32,0	24,0	39,50	
G 1.1/2	11	47,80	140	30	36,0	29,0	45,25	

Technische Informationen zum Thema Rohrgewinde siehe Seite T20  
For technical information concerning pipe threads, please see page T22

x = ab Lager, Zwischenverkauf vorbehalten  
o = nur solange Lagervorrat vorhanden  
x = normally ex stock  
o = available while stocks last

G

**Whitworth Rohrgewinde DIN ISO 228**  
Baumaße DIN 5156, Überlaufschaft  
**Whitworth Pipe Threads DIN ISO 228**  
Dimensions DIN 5156, Reduced shank

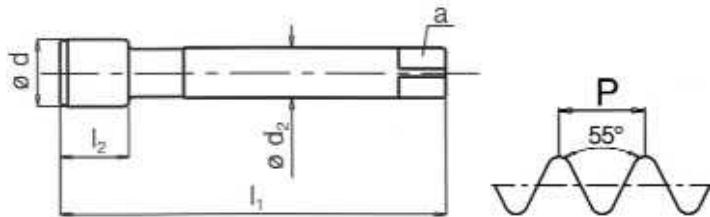

Katalog Nr. Bezeichnung	Catalogue No. Name	114 300 Hahnreiter	114 305 Dulofix	114 310 Dulofix TiN	114 318 Spiralo 15	114 326 Spiralo 35									
Toleranz	Tolerance	C	B	C	C	C									
Anschnittform	Chamfer form	2-3	4-5	2-3	2-3	2-3									
Anschnittlänge, Gang	Chamfer length, threads														
für Bohrungsart	For holes														
Sonderwerkstoff	Special material														
Zerspanungsgruppe, siehe Ausklappseite links	Machinability-group, See folder left page	<input type="checkbox"/> P <input type="checkbox"/> <input type="checkbox"/> <input type="checkbox"/> <input type="checkbox"/>	<input type="checkbox"/> P <input type="checkbox"/> <input type="checkbox"/> <input checked="" type="checkbox"/> N <input type="checkbox"/> <input type="checkbox"/>	<input type="checkbox"/> P <input type="checkbox"/> <input type="checkbox"/> <input type="checkbox"/> <input checked="" type="checkbox"/> N <input type="checkbox"/> <input type="checkbox"/>	<input type="checkbox"/> P <input type="checkbox"/> <input type="checkbox"/> <input checked="" type="checkbox"/> N <input type="checkbox"/> <input type="checkbox"/>	<input type="checkbox"/> P <input type="checkbox"/> <input type="checkbox"/> <input checked="" type="checkbox"/> N <input type="checkbox"/> <input type="checkbox"/>									
Oberfläche	Surface			TiN											
Ausführung	Variation														
Typenbeschreibung ab Seite	Type description from page	T2	T2	T2	T2	T2									
d	P	Ø	l <sub>1</sub>	l <sub>2</sub>	l <sub>2</sub>	d <sub>2</sub>	a		Verfügbarkeit Availability						
	Gg/1"	mm			SSP**										
G 1/8	28	09,73	90	17	12	7,0	5,5	8,80	x	x	x	x	x	x	x
G 1/4	19	13,16	100	20	14	11,0	9,0	11,80	x	x	x	x	x	x	x
G 3/8	19	16,66	100	22	18	12,0	9,0	15,25	x	x	x	x	x	x	x
G 1/2	14	20,96	125	25	18	16,0	12,0	19,00	x	x	x	x	x	x	x
G 5/8	14	22,91	125	25	18	18,0	14,5	21,00	x	x	x	x	x	x	x
G 3/4	14	26,44	140	28	22	20,0	16,0	24,50	x	x	x	x	x	x	x
G 7/8	14	30,20	150	28	22	22,0	18,0	28,25	x	x	x	x	x	x	x
G 1	11	33,25	160	30	25	25,0	20,0	30,75	x	x	x	x	x	x	x
G 1.1/8	11	37,90	170	30	25	28,0	22,0	35,50	x	x	x	x	x	x	x
G 1.1/4	11	41,91	170	30	25	32,0	24,0	39,50	x	x	x	x	x	x	x
G 1.1/2	11	47,80	190	32	28	36,0	29,0	45,25	x	x	x	x	x	x	x
G 1.3/4	11	53,75	190	32	32	40,0	32,0	51,10	x	x	x	x	x	x	x
G 2	11	59,61	220	40	33	45,0	35,0	57,00	x	x	x	x	x	x	x
G 2.1/2	11	75,18	275	40		50,0	39,0	73,00	x						

Technische Informationen zum Thema Rohrgewinde siehe Seite T20  
For technical information concerning pipe threads, please see page T22

x = ab Lager, Zwischenverkauf vorbehalten  
o = nur solange Lagervorrat vorhanden  
x = normally ex stock  
o = available while stocks last

\*\* SSP = Steilspirale  
\*\* SSP = quick spiral





G

**Whitworth Rohrgewinde DIN ISO 228**  
Baumaße DIN 5156, Überlaufschaft  
**Whitworth Pipe Threads DIN ISO 228**  
Dimensions DIN 5156, Reduced shank

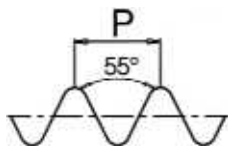
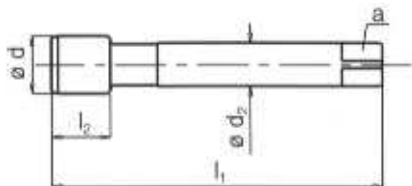

Katalog Nr. Bezeichnung	Catalogue No. Name	114 363 Nirofix 35	114 367 Nirofix 35 TiN	114 368 Nirofix 48 STY/WC					
Toleranz	Tolerance	C	C	C					
Anschnittform	Chamfer form	2-3	2-3	2-3					
Anschnittlänge, Gang	Chamfer length, threads								
für Bohrungsart	For holes								
Sonderwerkstoff	Special material	rostfreie Stähle Stainless steels							
Zerspanungsgruppe, siehe Ausklappseite links	Machinability-group, See folder left page	1.9.4		1.9.5 / 3.2					
Oberfläche	Surface	VAP	TiN	STY/WC					
Ausführung	Variation								
Typenbeschreibung ab Seite	Type description from page	T2	T2	T2					
d	P Gg/1"	Ø mm	l <sub>1</sub>	l <sub>2</sub>	l <sub>2</sub> SSP*	d <sub>2</sub>	a		Verfügbarkeit Availability
G 1/8	28	09,73	90	17	12	7,0	5,5	8,80	x
G 1/4	19	13,16	100	20	14	11,0	9,0	11,80	x
G 3/8	19	16,66	100	22	18	12,0	9,0	15,25	x
G 1/2	14	20,96	125	25	18	16,0	12,0	19,00	x
G 5/8	14	22,91	125	25	18	18,0	14,5	21,00	x
G 3/4	14	26,44	140	28	22	20,0	16,0	24,50	x
G 7/8	14	30,20	150	28	22	22,0	18,0	28,25	x
G 1	11	33,25	160	30	25	25,0	20,0	30,75	x
G 1.1/8	11	37,90	170	30	25	28,0	22,0	35,50	
G 1.1/4	11	41,91	170	30	25	32,0	24,0	39,50	
G 1.1/2	11	47,80	190	32	28	36,0	29,0	45,25	
G 1.3/4	11	53,75	190	32		40,0	32,0	51,10	
G 2	11	59,61	220	40	33	45,0	35,0	57,00	
G 2.1/2	11	75,18	275	40		50,0	39,0	73,00	

Technische Informationen zum Thema Rohrgewinde siehe Seite T20  
For technical information concerning pipe threads, please see page T22

\*\*SSP = Steilspirale  
\*\*SSP = quick spiral

x = ab Lager, Zwischenverkauf vorbehalten  
o = nur solange Lagervorrat vorhanden  
x = normally ex stock  
o = available while stocks last

# Maschinen-Gewindebohrer

## Machine Taps

# HAHNREITER HSS-E / HSS-EP\*

\* Pulvermetallurgisch erzeugter Schnellstahl / Made from powder metallurgy material

G



		114 370 Dulofix VS	114 371 Spiralo 35 VS	114 356 Multifix	114 357 Multifix 35		114 373 Dulofix HF	114 392 Dulofix HF TiCN	114 374 Spiralo 35 HF	114 393 Spir.35 HF TiCN
		B 4-5	C 2-3	B 4-5	C 2-3		B 4-5	B 4-5	C 2-3	C 2-3
		Vergütungsstähle Heat-treatable steels		Werkzeugstähle Toolsteels 1.7 / 3.23			hochfeste Stähle Hard materials 1.4.3/1.5.3 / 1.6.3/1.8			
		<input type="checkbox"/> P <input type="checkbox"/> <input type="checkbox"/> <input type="checkbox"/> <input type="checkbox"/> <input type="checkbox"/>	<input type="checkbox"/> P <input type="checkbox"/> <input type="checkbox"/> <input type="checkbox"/> <input type="checkbox"/> <input type="checkbox"/>	<input type="checkbox"/> P <input type="checkbox"/> <input type="checkbox"/> <input type="checkbox"/> <input type="checkbox"/> <input type="checkbox"/> <input type="checkbox"/> <input type="checkbox"/> <input type="checkbox"/> <input type="checkbox"/> <input type="checkbox"/>	<input type="checkbox"/> P <input type="checkbox"/> <input type="checkbox"/> <input type="checkbox"/> <input type="checkbox"/> <input type="checkbox"/> <input type="checkbox"/> <input type="checkbox"/> <input type="checkbox"/> <input type="checkbox"/>		<input type="checkbox"/> P <input type="checkbox"/> <input type="checkbox"/> <input type="checkbox"/> <input type="checkbox"/> <input type="checkbox"/>	<input type="checkbox"/> P <input type="checkbox"/> <input type="checkbox"/> <input type="checkbox"/> <input type="checkbox"/> <input type="checkbox"/> <input type="checkbox"/> <input type="checkbox"/> <input type="checkbox"/>	<input type="checkbox"/> P <input type="checkbox"/> <input type="checkbox"/> <input type="checkbox"/> <input type="checkbox"/> <input type="checkbox"/> <input type="checkbox"/> <input type="checkbox"/> <input type="checkbox"/>	<input type="checkbox"/> P <input type="checkbox"/> <input type="checkbox"/> <input type="checkbox"/> <input type="checkbox"/> <input type="checkbox"/> <input type="checkbox"/> <input type="checkbox"/> <input type="checkbox"/>
				Stygian	Stygian			TiCN		TiCN
		T2	T2	T2	T2		T2	T2	T2	T2
d	P Gg/1"	Verfügbarkeit Availability								
G 1/8	28	x	x	x	x		x	x	x	x
G 1/4	19	x	x	x	x		x	x	x	x
G 3/8	19	x	x	x	x		x	x	x	x
G 1/2	14	x	x	x	x		x	x	x	x
G 5/8	14	x	x	x	x					
G 3/4	14	x	x	x	x					
G 7/8	14	x	x	x	x					
G 1	11	x	x	x	x					
G 1.1/8	11									
G 1.1/4	11									
G 1.1/2	11									
G 1.3/4	11									
G 2	11									
G 2.1/2	11									

x = ab Lager, Zwischenverkauf vorbehalten  
o = nur solange Lagervorrat vorhanden  
x = normally ex stock  
o = available while stocks last

G

**Whitworth Rohrgewinde DIN ISO 228**

Baumaße DIN 2189, Überlaufschافت

**Whitworth Pipe Threads DIN ISO 228**

Dimensions DIN 2189, Reduced shank

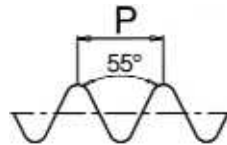
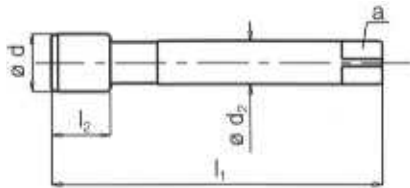

<b>Katalog Nr.</b>	<b>Catalogue No.</b>							<b>114 345</b>				
<b>Bezeichnung</b>	<b>Name</b>							<b>Drückfix N TiN</b>				
Toleranz	<i>Tolerance</i>							C				
Anschnittform	<i>Chamfer form</i>							2-3				
Anschnittlänge, Gang	<i>Chamfer length, threads</i>											
für Bohrungsart	<i>For holes</i>											
Sonderwerkstoff	<i>Special material</i>							Werkstoffe mit min. 10% Bruchdehnung Materials with elongation of min. 10%				
Zerspanungsgruppe, siehe Ausklappseite links	<i>Machinability-group, See folder left page</i>							<input type="checkbox"/> P <input type="checkbox"/> M <input type="checkbox"/> N <input type="checkbox"/>				
Oberfläche	<i>Surface</i>							TiN				
Ausführung	<i>Variation</i>											
Typenbeschreibung ab Seite	<i>Type description from page</i>							T2				
d	P	Ø	l <sub>1</sub>	l <sub>2</sub>	d <sub>2</sub>	a		Verfügbarkeit Availability				
	Gg/1"	mm										
G 1/8	28	09,73	90	18	7,0	5,5	9,30	x				
G 1/4	19	13,16	100	20	11,0	9,0	12,50	x				
G 3/8	19	16,66	100	22	12,0	9,0	16,00	x				
G 1/2	14	20,96	125	25	16,0	12,0	20,00	x				
G 5/8	14											
G 3/4	14	26,44	140	28	20,0	16,0	25,50	x				

Technische Informationen zum Thema Rohrgewinde siehe Seite T20  
For technical information concerning pipe threads, please see page T22

**x = ab Lager, Zwischenverkauf vorbehalten**  
**o = nur solange Lagervorrat vorhanden**  
x = normally ex stock  
o = available while stocks last



Rp

Whitworth Rohrgewinde DIN EN 10226, ISO 7,  
DIN 2999 (zurückgezogen)

zyl. Innengew., Baumaße DIN 5156, Überlaufschafft

Whitworth Pipe Threads DIN EN 10226, ISO 7,  
DIN 2999 (withdrawn)

cyl. int. threads, Dimensions DIN 5156, Reduced shank

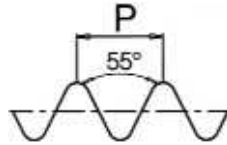
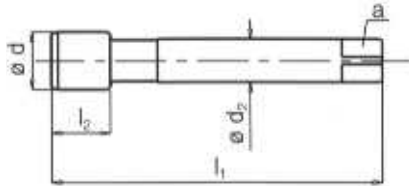

Katalog Nr. Bezeichnung	Catalogue No. Name	123 300 Hahnreiter	123 305 Dulofix	123 310 Dulofix TiN	123 326 Spiralo 35	123 335 Spiralo 35 TiN			
Toleranz	Tolerance	C	B	B	C	C			
Anschnittform	Chamfer form	2-3	4-5	4-5	2-3	2-3			
Anschnittlänge, Gang	Chamfer length, threads								
für Bohrungsart	For holes								
Sonderwerkstoff	Special material								
Zerspanungsgruppe, siehe Ausklappseite links	Machinability-group, See folder left page	<input type="checkbox"/> P <input type="checkbox"/> <input type="checkbox"/> <input type="checkbox"/> <input type="checkbox"/>	<input type="checkbox"/> P <input type="checkbox"/> <input type="checkbox"/> <input type="checkbox"/> <input type="checkbox"/> <input type="checkbox"/> N <input type="checkbox"/>	<input type="checkbox"/> P <input type="checkbox"/> <input type="checkbox"/> <input type="checkbox"/> <input type="checkbox"/> <input type="checkbox"/> N <input type="checkbox"/>	<input type="checkbox"/> P <input type="checkbox"/> <input type="checkbox"/> <input type="checkbox"/> <input type="checkbox"/> <input type="checkbox"/> N <input type="checkbox"/>	<input type="checkbox"/> P <input type="checkbox"/> <input type="checkbox"/> <input type="checkbox"/> <input type="checkbox"/> <input type="checkbox"/> N <input type="checkbox"/>			
Oberfläche	Surface			TiN		TiN			
Ausführung	Variation								
Typenbeschreibung ab Seite	Type description from page	T2	T2	T2	T2	T2			
d	P	Ø	l <sub>1</sub>	l <sub>2</sub>	l <sub>2</sub>	d <sub>2</sub>	a		Verfügbarkeit Availability
	Gg/1"	mm			SSP**				
Rp 1/8	28	09,73	90	17	12	7,0	5,5	8,60	x
Rp 1/4	19	13,16	100	20	14	11,0	9,0	11,50	x
Rp 3/8	19	16,66	100	22	18	12,0	9,0	15,00	x
Rp 1/2	14	20,96	125	25	18	16,0	12,0	18,50	x
Rp 3/4	14	26,44	140	28	22	20,0	16,0	24,00	x
Rp 1	11	33,25	160	30	25	25,0	20,0	30,25	x
Rp 1.1/4	11	41,91	170	30	25	32,0	24,0	39,00	x
Rp 1.1/2	11	47,80	190	32	28	36,0	29,0	45,00	x
Rp 2	11	59,61	220	40	33	45,0	35,0	56,50	x

Technische Informationen zum Thema Rohrgewinde siehe Seite T20  
For technical information concerning pipe threads, please see page T22

x = ab Lager, Zwischenverkauf vorbehalten  
o = nur solange Lagervorrat vorhanden  
x = normally ex stock  
o = available while stocks last

\*\* SSP = Steilspirale  
\*\* SSP = quick spiral

Rp



		123 360 Nirofix	123 366 Nirofix TiN	123 363 Nirofix 35	123 367 Nirofix 35 TiN	123 370 Dulofix VS	123 371 Spiralo 35 VS	123 356 Multifix	123 357 Multifix 35	
		B 4-5	B 4-5	C 2-3	C 2-3	B 4-5	C 2-3	B 4-5	C 2-3	
					rostfreie Stähle Stainless steels 1.9.4		Vergütungsstähle Heat-treatable steels		Werkzeugstähle Toolsteels 1.7 / 3.23	
		<input type="checkbox"/> M <input type="checkbox"/> <input type="checkbox"/> <input type="checkbox"/> <input type="checkbox"/>	<input type="checkbox"/> P <input type="checkbox"/> M <input type="checkbox"/> K <input type="checkbox"/> <input type="checkbox"/> <input type="checkbox"/>	<input type="checkbox"/> M <input type="checkbox"/> <input type="checkbox"/> <input type="checkbox"/> <input type="checkbox"/>	<input type="checkbox"/> P <input type="checkbox"/> M <input type="checkbox"/> K <input type="checkbox"/> <input type="checkbox"/> <input type="checkbox"/>	<input type="checkbox"/> P <input type="checkbox"/> <input type="checkbox"/> <input type="checkbox"/> <input type="checkbox"/>	<input type="checkbox"/> P <input type="checkbox"/> <input type="checkbox"/> <input type="checkbox"/> <input type="checkbox"/>	<input type="checkbox"/> P <input type="checkbox"/> <input type="checkbox"/> N <input type="checkbox"/> <input type="checkbox"/>	<input type="checkbox"/> P <input type="checkbox"/> <input type="checkbox"/> N <input type="checkbox"/> <input type="checkbox"/>	
		VAP	TiN	VAP	TiN			Stygian	Stygian	
		T2	T2	T2	T2	T2	T2	T2	T2	
d	P Gg/1"	Verfügbarkeit Availability								
Rp 1/8	28	x	x	x	x	x	x	x	x	
Rp 1/4	19	x	x	x	x	x	x	x	x	
Rp 3/8	19	x	x	x	x	x	x	x	x	
Rp 1/2	14	x	x	x	x	x	x	x	x	
Rp 3/4	14	x	x	x	x	x	x	x	x	
Rp 1	11	x	x	x	x	x	x	x	x	
Rp 1.1/4	11									
Rp 1.1/2	11									
Rp 2	11									

x = ab Lager, Zwischenverkauf vorbehalten  
o = nur solange Lagervorrat vorhanden  
x = normally ex stock  
o = available while stocks last

Rp



Rc (alt: BSPT)

Kegeliges Whitworth Rohrgewinde DIN-EN10226-2 / ISO 7

konisches Innengew., Konus 1:16, Baumaße DIN 5156, Überlaufschaft

Taper Whitworth Pipe Threads DIN-EN10226-2 / ISO 7

taper int. threads, taper 1:16, Dimensions DIN 5156, Reduced shank

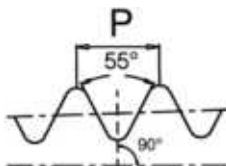
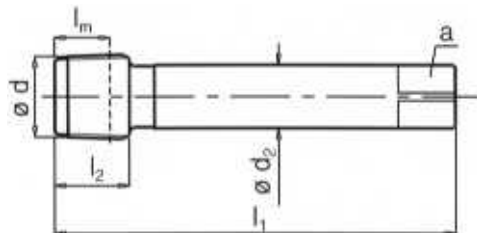

Katalog Nr. Bezeichnung	Catalogue No. Name	124 300 Hahnreiter	124 363 Nirofix 35								
Toleranz	Tolerance	C	C								
Anschnittform	Chamfer form	2-3	2-3								
Anschnittlänge, Gang	Chamfer length, threads										
für Bohrungsart	For holes										
Sonderwerkstoff	Special material		rostfreie Stähle Stainless steels 1.9.4 / 1.9.5								
Zerspanungsgruppe, siehe Ausklappseite links	Machinability-group, See folder left page	<input type="checkbox"/> P <input type="checkbox"/> <input type="checkbox"/> <input type="checkbox"/> <input type="checkbox"/>	<input type="checkbox"/> M <input type="checkbox"/> <input type="checkbox"/> <input type="checkbox"/>								
Oberfläche	Surface		VAP								
Ausführung	Variation										
Typenbeschreibung ab Seite	Type description from page	T2	T2								
d P Gg/1"	Ø mm	l <sub>1</sub>	l <sub>2</sub>	l <sub>m</sub>	d <sub>2</sub>	a		Verfügbarkeit Availability			
							Kernloch Core hole				
							zylindrisch cylindrical	konisch taper			
							B <sub>z</sub>	B <sub>k</sub>			
Rc 1/8	28	09,73	90	14	10,1	7,0	5,5	8,20	8,57	x	x
Rc 1/4	19	13,16	100	20	15,0	11,0	9,0	11,00	11,45	x	x
Rc 3/8	19	16,66	100	21	15,4	12,0	9,0	14,50	14,95	x	x
Rc 1/2	14	20,96	125	25	20,4	16,0	12,0	18,00	18,63	x	x
Rc 3/4	14	26,44	140	29	21,7	20,0	16,0	23,40	24,12	x	x
Rc 1	11	33,25	160	35	26,0	25,0	20,0	29,50	30,29	x	x

zylindrisch  
cylindrical

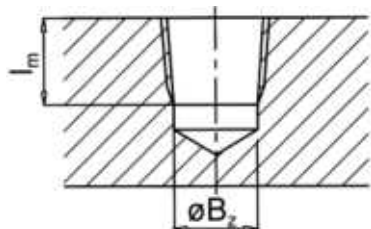

konisch  
taper

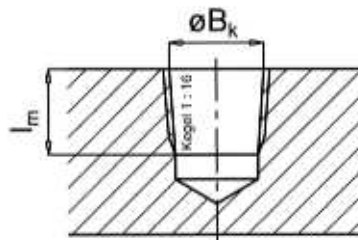

Technische Informationen zum Thema Rohrgewinde siehe Seite T20  
For technical information concerning pipe threads, please see page T22

x = ab Lager, Zwischenverkauf vorbehalten  
o = nur solange Lagervorrat vorhanden  
x = normally ex stock  
o = available while stocks last

**NPT**

**Amerikanisches Kegeliges Rohrgewinde - Konus 1 : 16**

nach ANSI B 1.20.1 "allg. Verwendung", Baumaße Werksnorm

**American Taper Pipe Thread - Taper 1 : 16**

accord. to ANSI B 1.20.1 "general purpose", Dimensions manufacturer's standard

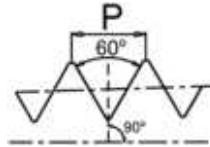
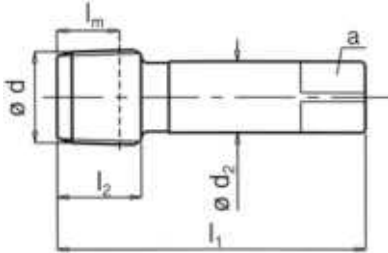

NPT

Katalog Nr. Bezeichnung	Catalogue No. Name		117 100 Hahnreiter	117 101 Hahnreiter	117 103 Hahnreiter AZ
Toleranz	Tolerance		C	Nr. 1	C
Anschnittform	Chamfer form		2-3	5	2-3
Anschnittlänge, Gang	Chamfer length, threads				
für Bohrungsart	For holes				
Sonderwerkstoff	Special material				weiches Material soft material 1.1.0 / 3.20 / 4.14
Zerspanungsgruppe, siehe Ausklappseite links	Machinability-group, See folder left page		<input type="checkbox"/> P <input type="checkbox"/> <input type="checkbox"/> <input type="checkbox"/> <input type="checkbox"/>	<input type="checkbox"/> P <input type="checkbox"/> <input type="checkbox"/> <input type="checkbox"/> <input type="checkbox"/>	<input type="checkbox"/> P <input type="checkbox"/> <input type="checkbox"/> <input type="checkbox"/> <input type="checkbox"/>
Oberfläche	Surface				
Ausführung	Variation			Vorschneider Taper	ausgesetzte Zähne Interrupted teeth
Typenbeschreibung ab Seite	Type description from page		T2	T2	T2
d Gg/1" Code	l <sub>1</sub> l <sub>2</sub> l <sub>m</sub> d <sub>2</sub> a		Verfügbarkeit Availability		
		Kernloch Core hole			
		zylindrisch cylindrical			
		B <sub>z</sub>			
		konisch taper			
		B <sub>k</sub>			
1/16	27 08,85 63 12 9,2 6,0 4,9	6,20	6,39	x	x
1/8	27 10,62 63 12 9,3 7,0 5,5	8,50	8,74	x	x
1/4	18 14,14 63 18 13,5 11,0 9,0	11,10	11,36	x	x
3/8	18 17,57 70 18 13,9 12,0 9,0	14,55	14,80	x	x
1/2	14 21,90 80 24 18,1 16,0 12,0	18,00	18,32	x	x
3/4	14 27,23 100 24 18,6 20,0 16,0	23,25	23,67	x	x
1	11,5 34,18 110 30 22,3 25,0 20,0	29,20	29,69	x	x
1.1/4	11,5 42,90 125 30 22,8 32,0 24,0	37,95	38,45	x	x
1.1/2	11,5 48,94 140 30 22,8 36,0 29,0	44,00	44,52	x	x
2	11,5 61,00 160 30 22,8 45,0 35,0	56,00	56,56	x	x

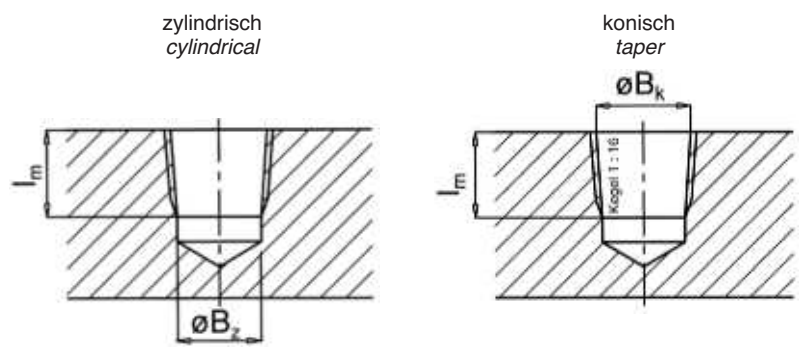

Technische Informationen zum Thema Rohrgewinde siehe Seite T21  
For technical information concerning pipe threads, please see page T23

x = ab Lager, Zwischenverkauf vorbehalten  
o = nur solange Lagervorrat vorhanden  
x = normally ex stock  
o = available while stocks last



**NPT**

**Amerikanisches Kegeliges Rohrgewinde - Konus 1 : 16**

nach ANSI B 1.20.1 "allg. Verwendung", Baumaße Werksnorm

**American Taper Pipe Thread - Taper 1 : 16**

accord. to ANSI B 1.20.1 "general purpose", Dimensions manuf. standard

HSS-EP

HSS-EP

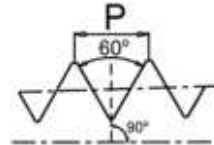
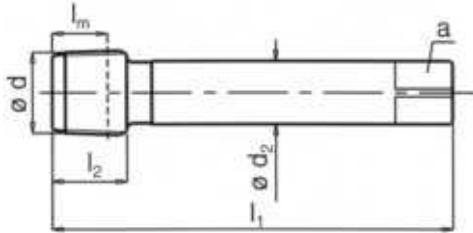

NPT

Katalog Nr. Bezeichnung	Catalogue No. Name		117 364 Nirofix 15		117 376 Hahnreiter Ni AZ								
Toleranz	Tolerance		C		C								
Anschnittform	Chamfer form		2-3		2-3								
Anschnittlänge, Gang für Bohrungsart	Chamfer length, threads For holes												
Sonderwerkstoff	Special material		rostfreie Stähle Stainless steels 1.9.4 / 1.9.5		Nickel-Leg Nickel-alloy 5.25								
Zerspanungsgruppe, siehe Ausklappseite links	Machinability-group, See folder left page		<input type="checkbox"/> M <input type="checkbox"/> <input type="checkbox"/> <input type="checkbox"/>		<input type="checkbox"/> <input type="checkbox"/> <input type="checkbox"/> <input checked="" type="checkbox"/> S								
Oberfläche	Surface		VAP										
Ausführung	Variation				ausgesetzte Zähne Interrupted teeth								
Typenbeschreibung ab Seite	Type description from page		T2		T2								
d Gg/1" mm	P Ø mm	l <sub>1</sub>	l <sub>2</sub>	l <sub>m</sub>	d <sub>2</sub>	a			Verfügbarkeit Availability				
								Kernloch Core hole					
								zylindrisch cylindrical	konisch taper				
								B <sub>z</sub>	B <sub>k</sub>				
1/16	27	08,85	90	12	9,2	8,0	6,2	6,20	6,39		x		x
1/8	27	10,62	90	12	9,3	11,0	9,0	8,50	8,74		x		x
1/4	18	14,14	100	18	13,5	14,0	11,0	11,10	11,36		x		x
3/8	18	17,57	100	18	13,9	16,0	12,0	14,55	14,80		x		x
1/2	14	21,90	125	24	18,1	18,0	14,5	18,00	18,32		x		x

zylindrisch  
cylindrical

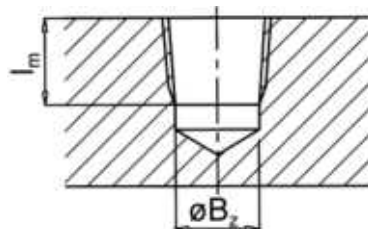

konisch  
taper

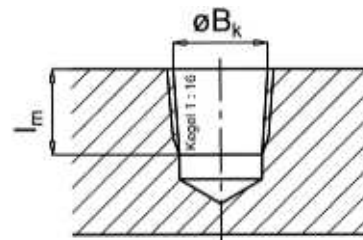

Technische Informationen zum Thema Rohrgewinde siehe Seite T21  
For technical information concerning pipe threads, please see page T23

x = ab Lager, Zwischenverkauf vorbehalten  
o = nur solange Lagervorrat vorhanden  
x = normally ex stock  
o = available while stocks last

**NPTF**

**Amerikanisches Kegeliges Rohrgewinde - Konus 1 : 16**  
nach ANSI B 1.20.3 "trocken dichtend", Baumaße Werksnorm

**American Taper Pipe Thread - Taper 1 : 16**

accord. to ANSI B 1.20.3 "dry sealing", Dimensions manufacturer's standard

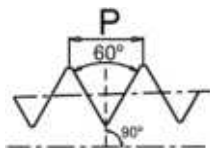
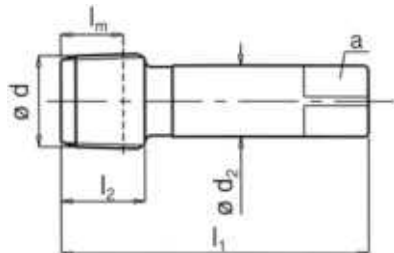

Katalog Nr. Bezeichnung	Catalogue No. Name	118 100 Hahnreiter									
Toleranz	Tolerance										
Anschnittform	Chamfer form	C									
Anschnittlänge, Gang für Bohrungsart	Chamfer length, threads For holes	2-3									
Sonderwerkstoff	Special material										
Zerspanungsgruppe, siehe Ausklappseite links	Machinability-group, See folder left page	<input checked="" type="checkbox"/> <input type="checkbox"/> <input type="checkbox"/> <input type="checkbox"/>									
Oberfläche	Surface										
Ausführung	Variation										
Typenbeschreibung ab Seite	Type description from page		T2								
d Gg/1"	P Code	l <sub>1</sub>	l <sub>2</sub>	l <sub>m</sub>	d <sub>2</sub>	a			Verfügbarkeit Availability		
							zylindrisch cylindrical B <sub>z</sub>	konisch taper B <sub>k</sub>			
1/16	27	08,85	63	12	9,2	6,0	4,9	6,20	6,42	x	
1/8	27	10,62	63	12	9,3	7,0	5,5	8,50	8,76	x	
1/4	18	14,14	63	18	13,5	11,0	9,0	11,00	11,40	x	
3/8	18	17,57	70	18	13,9	12,0	9,0	14,50	14,84	x	
1/2	14	21,90	80	24	18,1	16,0	12,0	17,80	18,33	x	
3/4	14	27,23	100	24	18,6	20,0	16,0	23,10	23,68	x	
1	11,5	34,18	110	30	22,3	25,0	20,0	29,10	29,72	x	
1.1/4	11,5	42,90	125	30	22,8	32,0	24,0	37,80	38,48	x	
1.1/2	11,5	48,94	140	30	22,8	36,0	29,0	43,90	44,55	x	
2	11,5	61,00	160	30	22,8	45,0	35,0	55,90	56,59	x	

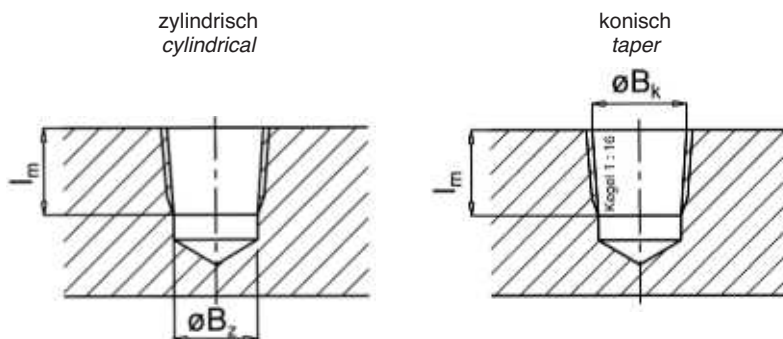

Technische Informationen zum Thema Rohrgewinde siehe Seite T21  
For technical information concerning pipe threads, please see page T23

x = ab Lager, Zwischenverkauf vorbehalten  
o = nur solange Lagervorrat vorhanden  
x = normally ex stock  
o = available while stocks last

**NPTF**

**Amerikanisches Kegeliges Rohrgewinde - Konus 1 : 16**  
nach ANSI B 1.20.3 "trocken dichtend", Baumaße ≈ DIN 5156  
**American Taper Pipe Thread - Taper 1 : 16**  
accord. to ANSI B 1.20.3 "dry sealing", Dimensions ≈ DIN 5156

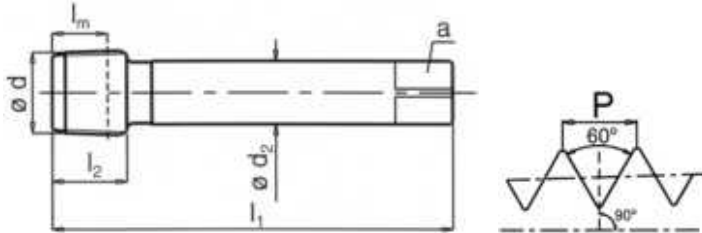

NPTF

Katalog Nr. Bezeichnung	Catalogue No. Name		118 300 Hahnreiter	118 381 Gussfix									
Toleranz	Tolerance		C	C									
Anschnittform	Chamfer form		2-3	2-3									
Anschnittlänge, Gang	Chamfer length, threads												
für Bohrungsart	For holes												
Sonderwerkstoff	Special material			Grauguss Grey cast iron 2.11									
Zerspanungsgruppe, siehe Ausklappseite links	Machinability-group, See folder left page		<input checked="" type="checkbox"/> P <input type="checkbox"/> <input type="checkbox"/> <input type="checkbox"/> <input type="checkbox"/> <input type="checkbox"/>	<input type="checkbox"/> <input checked="" type="checkbox"/> K <input type="checkbox"/> <input type="checkbox"/> <input type="checkbox"/>									
Oberfläche	Surface			Nit									
Ausführung	Variation												
Typenbeschreibung ab Seite	Type description from page		T2	T2									
d Gg/1" mm	P Ø mm	l <sub>1</sub>	l <sub>2</sub>	l <sub>m</sub>	d <sub>2</sub>	a		Verfügbarkeit Availability					
								Kernloch Core hole					
								zylindrisch cylindrical	konisch taper				
								<b>B<sub>z</sub></b>	<b>B<sub>k</sub></b>				
1/16	27	08,85	90	12	9,2	6,0	4,9	6,20	6,42	x	x		
1/8	27	10,62	90	12	9,3	7,0	5,5	8,50	8,76	x	x		
1/4	18	14,14	100	18	13,5	11,0	9,0	11,00	11,40	x	x		
3/8	18	17,57	100	18	13,9	12,0	9,0	14,50	14,84	x	x		
1/2	14	21,90	125	24	18,1	16,0	12,0	17,80	18,33	x	x		
3/4	14	27,23	140	24	18,6	20,0	16,0	23,10	23,68	x	x		
1	11,5	34,18	160	30	22,3	25,0	20,0	29,10	29,72	x	x		
1.1/4	11,5	42,90	170	30	22,8	32,0	24,0	37,80	38,48	x			
1.1/2	11,5	48,94	190	30	22,8	36,0	29,0	43,90	44,55	x			
2	11,5	61,00	220	30	22,8	45,0	35,0	55,90	56,59	x			

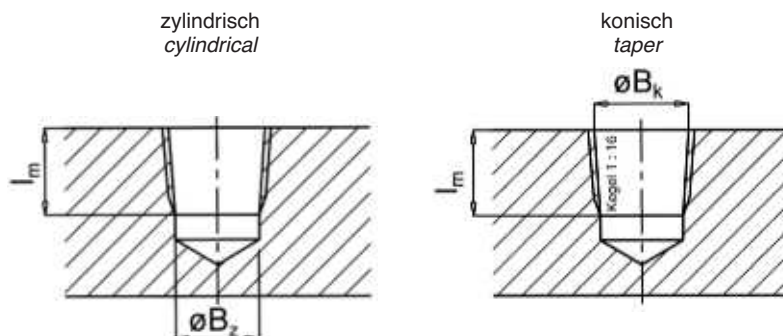

Technische Informationen zum Thema Rohrgewinde siehe Seite T21  
For technical information concerning pipe threads, please see page T23

x = ab Lager, Zwischenverkauf vorbehalten  
o = nur solange Lagervorrat vorhanden  
x = normally ex stock  
o = available while stocks last



Pg

Stahlpanzerrohr-Gewinde, DIN 40430

Baumaße DIN 40432, Satz à 2 Stück

Steel Conduit Thread, DIN 40430

Dimensions DIN 40432, Set of 2 pieces

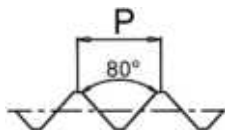
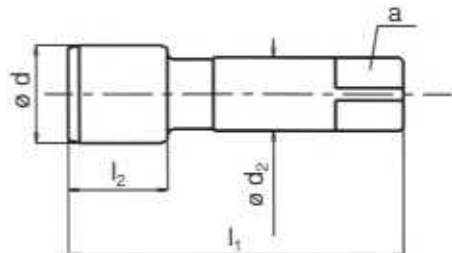

Katalog Nr. Bezeichnung	Catalogue No. Name	119 061 Hahnreiter	119 062 Hahnreiter	119 060 Hahnreiter						
Toleranz	Tolerance	Nr. 1								
Anschnittform	Chamfer form		C							
Anschnittlänge, Gang	Chamfer length, threads	5	2-3							
für Bohrungsart	For holes									
hauptsächliches Einsatzgebiet	Main use	alle gut spanbaren Materialien bis 800 N/mm <sup>2</sup> all free machining materials up to 800 N/mm <sup>2</sup>								
Zerspanungsgruppe, siehe Ausklappseite links	Machinability-group, See folder left page	<input type="checkbox"/> P <input type="checkbox"/> K <input type="checkbox"/> N <input type="checkbox"/> <input type="checkbox"/> P <input type="checkbox"/> K <input type="checkbox"/> N <input type="checkbox"/> <input type="checkbox"/> P <input type="checkbox"/> K <input type="checkbox"/> N <input type="checkbox"/>								
Ausführung	Variation	Vorschneider Taper	Fertigschneider Bottoming	Satz à 2 Stück Set of 2 pc.						
Oberfläche	Surface									
d	P Gg/1"	Ø mm	l <sub>1</sub>	l <sub>2</sub>	d <sub>2</sub>	a		Verfügbarkeit Availability		
Pg 7	20	12,50	70	20	9,0	7,0	11,35	o	o	o
Pg 9	18	15,20	70	20	12,0	9,0	13,95	o	o	o
Pg 11	18	18,60	80	22	14,0	11,0	17,35	o	o	o
Pg 13,5	18	20,40	80	22	16,0	12,0	19,15	o	o	o
Pg 16	18	22,50	80	22	18,0	18,0	21,25	o	o	o
Pg 21	16	28,30	90	22	22,0	18,0	26,90	o	o	o
Pg 29	16	37,00	100	25	28,0	22,0	35,60	o	o	o
Pg 36	16	47,00	140	32	36,0	29,0	45,60	o	o	o
Pg 42	16	54,00	140	32	40,0	32,0	52,60	o	o	o
Pg 48	16	59,30	160	32	45,0	35,0	57,90	o	o	o

Für Elektroinstallationsrohre ist nach DIN EN 60423 das PG Gewinde durch Metrisches Feingewinde ersetzt worden, siehe Seite G50.  
Für Neukonstruktionen sollte PG Gewinde daher nicht mehr verwendet werden.  
For "Conduits for electrical purposes" according to DIN EN 60423 the PG thread was replaced by Metric Fine Thread, please see page G50.  
PG thread should not be used for new applications.

x = ab Lager, Zwischenverkauf vorbehalten  
o = nur solange Lagervorrat vorhanden  
x = normally ex stock  
o = available while stocks last

**Pg**

**Stahlpanzerrohr-Gewinde, DIN 40430**  
Baumaße DIN 40433, Überlaufschafft  
**Steel Conduit Thread, DIN 40430**  
Dimensions DIN 40433, Reduced shank



Katalog Nr. Bezeichnung	Catalogue No. Name	119 300 Hahnreiter	119 305 Dulofix	119 600 Automat MS	119 601 Autom. MS +0,05					
Toleranz	Tolerance	C	B	E	+0,05					
Anschnittform	Chamfer form	2-3	4-5	1,5-2	E					
Anschnittlänge, Gang	Chamfer length, threads				1,5-2					
für Bohrungsart	For holes									
hauptsächliches Einsatzgebiet	Main use			Messing Brass 3.21	Messing Brass 3.21					
Zerspanungsgruppe, siehe Ausklappseite links	Machinability-group, See folder left page	<input type="checkbox"/> P <input type="checkbox"/> <input type="checkbox"/> <input type="checkbox"/> <input type="checkbox"/> <input type="checkbox"/>	<input type="checkbox"/> P <input type="checkbox"/> <input type="checkbox"/> <input type="checkbox"/> <input type="checkbox"/> <input type="checkbox"/> <input type="checkbox"/> N <input type="checkbox"/>	<input type="checkbox"/> <input type="checkbox"/> <input type="checkbox"/> <input type="checkbox"/> <input type="checkbox"/> <input type="checkbox"/> N <input type="checkbox"/>	<input type="checkbox"/> <input type="checkbox"/> <input type="checkbox"/> <input type="checkbox"/> <input type="checkbox"/> <input type="checkbox"/> N <input type="checkbox"/>					
Oberfläche	Surface									
Ausführung	Variation				Aufmaß Oversize					
Typenbeschreibung ab Seite	Type description from page	T2	T2	T2	T2					
d	P Gg/1" Ø mm	l <sub>1</sub>	l <sub>2</sub>	d <sub>2</sub>	a		Verfügbarkeit Availability			
Pg 7	20 12,50	100	20	9,0	7,0	11,35	o	o		
Pg 9	18 15,20	100	22	12,0	9,0	13,95	o	o		
Pg 11	18 18,60	110	22	14,0	11,0	17,35	o	o		
Pg 13,5	18 20,40	125	25	16,0	12,0	19,15	o	o		
Pg 16	18 22,50	125	25	18,0	14,5	21,25	o	o		
Pg 21	16 28,30	150	28	22,0	18,0	26,90	o	o		
Pg 29	16 37,00	170	28	28,0	22,0	35,60	o	o		
Pg 36	16 47,00	190	32	36,0	29,0	45,60	o	o		
Pg 42	16 54,00	190	32	40,0	32,0	52,60	o	o		
Pg 48	16 59,30	220	40	45,0	35,0	57,90	o	o		

**Automaten-Gewindebohrer**  
Taps for Automatic Lathes

**Pg**

**Stahlpanzerrohr-Gewinde, DIN 40430**  
Baumaße Werksnorm  
**Steel Conduit Thread, DIN 40430**  
Dimensions manufacturer's standard

Pg 7	20	12,50	70	20	9,0	7,0	11,35				o	o
Pg 9	18	15,20	70	20	12,0	9,0	13,95				o	o
Pg 11	18	18,60	70	22	16,0 (15,0)*	12,0	17,35				o	o
Pg 13,5	18	20,40	70	22	16,0 (15,0)*	12,0	19,15				o	o
Pg 16	18	22,50	70	22	16,0 (15,0)*	12,0	21,25				o	o
Pg 21	16	28,30	70	24	18,0	14,5	26,90				o	o
Pg 29	16	37,00	70	25	18,0	14,5	35,60				o	o
Pg 36	16	47,00	70	25	18,0	14,5	45,60				o	o
Pg 42	16	54,00	90	25	30,0	24,0	52,60				o	
Pg 48	16	59,30	90	25	30,0	24,0	57,90				o	

\*solange Lagerbestand liefern wir mit Schaft Ø 15,0  
\*as long as available we will send shank Ø 15,0

x = ab Lager, Zwischenverkauf vorbehalten  
o = nur solange Lagerbestand vorhanden  
x = normally ex stock  
o = available while stocks last

**BSW**

**Whitworth Grobgewinde, BS 84**  
Baumaße DIN 2184 Teil 2, Satz à 3 Stück  
**Whitworth Coarse Threads BS 84**  
Dimensions DIN 2184 part 2, Set of 3 pieces

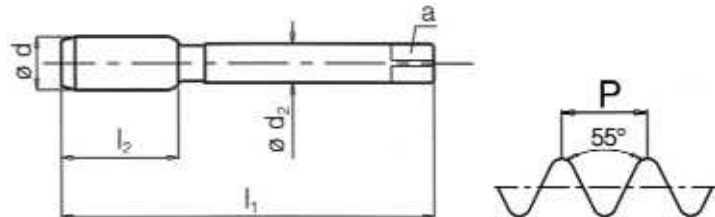

Katalog Nr. Bezeichnung	Catalogue No. Name	115 001 Hahnreiter	115 002 Hahnreiter	115 003 Hahnreiter	115 000 Hahnreiter							
Toleranz	Tolerance	Nr.1	Nr.2	C								
Anschnittform	Chamfer form	5	3-4	2-3								
Anschnittlänge, Gang	Chamfer length, threads											
für Bohrungsart	For holes											
hauptsächlich Einsatzgebiet	Main use	alle gut spanbaren Materialien bis 800 N/mm <sup>2</sup> all free machining materials up to 800 N/mm <sup>2</sup>										
Zerspanungsgruppe, siehe Ausklappseite links	Machinability-group, See folder left page	<input type="checkbox"/> P <input type="checkbox"/> K <input type="checkbox"/> N <input type="checkbox"/>	<input type="checkbox"/> P <input type="checkbox"/> K <input type="checkbox"/> N <input type="checkbox"/>	<input type="checkbox"/> P <input type="checkbox"/> K <input type="checkbox"/> N <input type="checkbox"/>	<input type="checkbox"/> P <input type="checkbox"/> K <input type="checkbox"/> N <input type="checkbox"/>							
Ausführung	Variation	Vorschneider Taper	Mittelschneider Second	Fertigschneider Bottoming	Satz à 3 Stück Set of 3 pc.							
Oberfläche	Surface											
d	P Gg/1"	Ø mm	l <sub>1</sub>	l <sub>2</sub>	d <sub>2</sub>	a		Verfügbarkeit Availability				
1/8	- 40	03,17	40	11	3,5	2,7	2,00	x	x	x		x
5/32	- 32	03,97	45	12	4,5	3,4	3,20	x	x	x		x
3/16	- 24	04,76	50	14	6,0	4,9	3,60	x	x	x		x
1/4	- 20	06,35	56	16	6,0	4,9	5,10	x	x	x		x
5/16	- 18	07,94	63	20	6,0	4,9	6,50	x	x	x		x
3/8	- 16	09,53	70	22	7,0	5,5	7,90	x	x	x		x
7/16	- 14	11,11	70	24	8,0	6,2	9,30	x	x	x		x
1/2	- 12	12,70	75	25	9,0	7,0	10,50	x	x	x		x
5/8	- 11	15,88	80	32	12,0	9,0	13,50	x	x	x		x
3/4	- 10	19,05	95	32	14,0	11,0	16,40	x	x	x		x
7/8	- 9	22,23	100	32	18,0	14,5	19,25	x	x	x		x
1	- 8	25,40	110	36	18,0	14,5	22,00	x	x	x		x
1.1/4	- 7	31,75	120	40	22,0	18,0	27,75	o	o	o		o
1.1/2	- 6	38,10	150	50	28,0	22,0	33,50					
2	- 4,5	50,80	180	65	40,0	32,0	44,50					

x = ab Lager, Zwischenverkauf vorbehalten  
o = nur solange Lagervorrat vorhanden  
x = normally ex stock  
o = available while stocks last

**BSW**

**Whitworth Grobgewinde, BS 84**  
Baumaße DIN 2184 Teil 1, verstärkter Schaft  
**Whitworth Coarse Threads BS 84**  
Dimensions DIN 2184 part 1, Reinforced shank

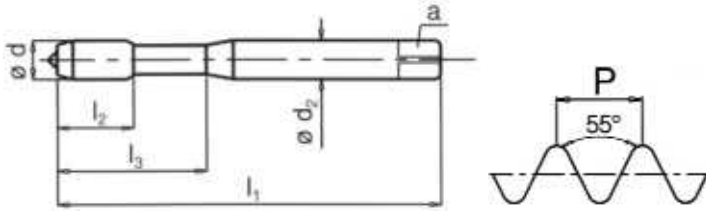

BSW

Katalog Nr. Bezeichnung	Catalogue No. Name	115 200 Hahnreiter	115 205 Dulofix	115 218 Spiralo 15	115 226 Spiralo 35	115 281 Gussfix														
Toleranz	Tolerance	C	B	C	C	C														
Anschnittform	Chamfer form	2-3	4-5	2-3	2-3	2-3														
Anschnittlänge, Gang für Bohrungsart	Chamfer length, threads For holes																			
Sonderwerkstoff	Special material					Grauguss Grey cast iron 2.11														
Zerspanungsgruppe, siehe Ausklappseite links	Machinability-group, See folder left page	<input type="checkbox"/> P <input type="checkbox"/> <input type="checkbox"/> <input type="checkbox"/> <input type="checkbox"/>	<input type="checkbox"/> P <input type="checkbox"/> <input type="checkbox"/> <input checked="" type="checkbox"/> N <input type="checkbox"/>	<input type="checkbox"/> P <input type="checkbox"/> <input type="checkbox"/> <input checked="" type="checkbox"/> N <input type="checkbox"/>	<input type="checkbox"/> P <input type="checkbox"/> <input type="checkbox"/> <input checked="" type="checkbox"/> N <input type="checkbox"/>	<input type="checkbox"/> <input type="checkbox"/> <input type="checkbox"/> <input checked="" type="checkbox"/> K <input type="checkbox"/>														
Oberfläche	Surface					Nit														
Ausführung	Variation																			
Typenbeschreibung ab Seite	Type description from page	T2	T2	T2	T2	T2														
d	P	Ø	l <sub>1</sub>	l <sub>2</sub>	l <sub>2</sub>	l <sub>3</sub>	d <sub>2</sub>	a		Verfügbarkeit Availability										
	Gg/1"	mm			SSP**															
1/8	-	40	03,17	56	10	6	18	3,5	2,7	2,00	x	x	o	x						
3/16	-	24	04,76	70	14	9	25	6,0	4,9	3,60	x	x	o	x						x
1/4	-	20	06,35	80	17	12	30	7,0	5,5	5,10	x	x	o	x						x
5/16	-	18	07,94	90	18	12	35	8,0	6,2	6,50	x	x	o	x						x
3/8	-	16	09,53	100	20	14	39	10,0	8,0	7,90	x	x	o	x						x

\*\*SSP = Steilspirale  
\*\*SSP = quick spiral

x = ab Lager, Zwischenverkauf vorbehalten  
o = nur solange Lagervorrat vorhanden  
x = normally ex stock  
o = available while stocks last

**BSW**

**Whitworth Grobgewinde, BS 84**

Baumaße DIN 2184 Teil 1, Überlaufschaff

**Whitworth Coarse Threads BS 84**

Dimensions DIN 2184 part 1, Reduced shank

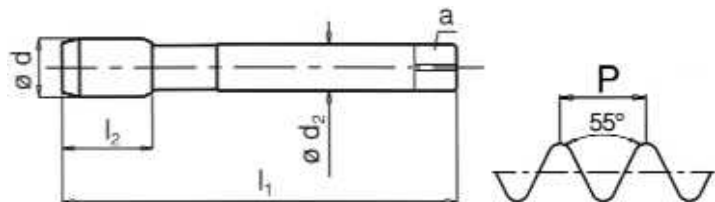

Katalog Nr. Bezeichnung	Catalogue No. Name	115 300 Hahnreiter	115 305 Dulofix	115 318 Spiralo 15	115 326 Spiralo 35	115 381 Gussfix													
Toleranz	Tolerance	C	B	C	C	C													
Anschnittform	Chamfer form	2-3	4-5	2-3	2-3	2-3													
Anschnittlänge, Gang	Chamfer length, threads																		
für Bohrungsart	For holes																		
Sonderwerkstoff	Special material					Grauguss Grey cast iron 2.11													
Zerspanungsgruppe, siehe Ausklappseite links	Machinability-group, See folder left page	P <input type="checkbox"/> <input type="checkbox"/> <input type="checkbox"/> <input type="checkbox"/>	P <input type="checkbox"/> <input type="checkbox"/> N <input type="checkbox"/> <input type="checkbox"/>	P <input type="checkbox"/> <input type="checkbox"/> N <input type="checkbox"/> <input type="checkbox"/>	P <input type="checkbox"/> <input type="checkbox"/> N <input type="checkbox"/> <input type="checkbox"/>	<input type="checkbox"/> <input type="checkbox"/> K <input type="checkbox"/> <input type="checkbox"/>													
Oberfläche	Surface					Nit													
Ausführung	Variation																		
Typenbeschreibung ab Seite	Type description from page	T2	T2	T2	T2	T2													
d	P	Ø	l <sub>1</sub>	l <sub>2</sub>	l <sub>2</sub>	d <sub>2</sub>	a	Verfügbarkeit Availability											
	Gg/1"	mm			SSP**														
5/16	- 18	07,94	90	22		6,0	4,9	6,50	o										
7/16	- 14	11,11	100	22	18	8,0	6,2	9,30	x	x									
1/2	- 12	12,70	110	25	18	9,0	7,0	10,50	x	x									
5/8	- 11	15,88	110	25	20	12,0	9,0	13,50	x	x									
3/4	- 10	19,05	125	30	25	14,0	11,0	16,40	x	x									
7/8	- 9	22,23	140	34	28	18,0	14,5	19,25	x	x									
1	- 8	25,40	160	36	32	18,0	14,5	22,00	x	x									
1.1/8	- 7	28,58	180	40		22,0	18,0	24,75	x										
1.1/4	- 7	31,75	180	40		22,0	18,0	27,75	x										
1.3/8	- 6	34,93	200	45		28,0	22,0	30,50	x										
1.1/2	- 6	38,10	200	45		28,0	22,0	33,50	x										
1.3/4	- 5	44,45	220	56		36,0	29,0	39,00	x										
2	- 4,5	50,80	250	63		40,0	32,0	44,50	x										

\*\*SSP = Steilschneidspiral  
\*\*SSP = quick spiral

x = ab Lager, Zwischenverkauf vorbehalten  
o = nur solange Lagervorrat vorhanden  
x = normally ex stock  
o = available while stocks last

Rd

Rundgewinde DIN 405

Baumaße Werksnorm

Round Threads DIN 405

Dimensions manufacturer's standard

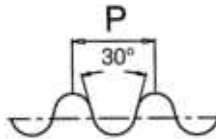
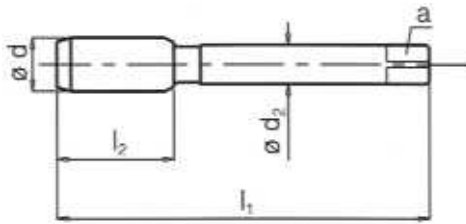

Katalog Nr. Bezeichnung	Catalogue No. Name	122 600 Automat MS	122 610 Automat MS LH	122 620 Automat								
Toleranz	Tolerance	7H	7H	7H								
Anschnittform	Chamfer form	C	C	C								
Anschnittlänge, Gang	Chamfer length, threads	2	2	2								
für Bohrungsart	For holes											
Sonderwerkstoff	Special material	Messing Brass 3.21		Automatenstahl free cutting steel 1.2								
Zerspanungsgruppe, siehe Ausklappseite links	Machinability-group, See folder left page	<input type="checkbox"/>	<input type="checkbox"/>	<input checked="" type="checkbox"/>	<input type="checkbox"/>	<input type="checkbox"/>						
Oberfläche	Surface											
Ausführung	Variation		Links Left hand									
Typenbeschreibung ab Seite	Type description from page	T2	T2	T2								
d	P Gg/1"	Ø mm	l <sub>1</sub>	l <sub>2</sub>	l <sub>2</sub> SSP**	l <sub>3</sub>	d <sub>2</sub>	a		Verfügbarkeit Availability		
Rd 8	x 1/10	08	70	22			8,0	6,2	6,00	x	x	x
Rd 9	x 1/10	09	70	22			8,0	6,2	7,00	x	x	x
Rd 10	x 1/10	10	70	22			8,0	6,2	8,00	x	x	x
Rd 11	x 1/10	11	80	25			8,0	6,2	9,00	x	x	x
Rd 12	x 1/10	12	90	25			9,0	7,0	10,00	x	x	x
Rd 14	x 1/8	14	100	32			11,0	9,0	11,50	x	x	x
Rd 16	x 1/8	16	100	32			12,0	9,0	13,50	x	x	x
Rd 18	x 1/8	18	110	32			14,0	11,0	15,50	x	x	x
Rd 20	x 1/8	20	110	32			16,0	12,0	17,50	x	x	x
Rd 22	x 1/8	22	110	32			18,0	14,5	19,50	x		
Rd 24	x 1/8	24	125	32			18,0	14,5	21,50	x		
Rd 26	x 1/8	26	125	36			18,0	14,5	23,50	x		
Rd 28	x 1/8	28	125	36			20,0	16,0	25,50	x		
Rd 30	x 1/8	30	125	36			22,0	18,0	27,50	x		

x = ab Lager, Zwischenverkauf vorbehalten  
o = nur solange Lagervorrat vorhanden  
x = normally ex stock  
o = available while stocks last



**Tr**

**Metrisches ISO Trapezgewinde, DIN 103**  
Baumaße Werksnorm, Satz à 3 Stück  
**Metric ISO Trapezoidal Threads DIN 103**  
Dimensions manufacturer's standard, Set of 3 pieces

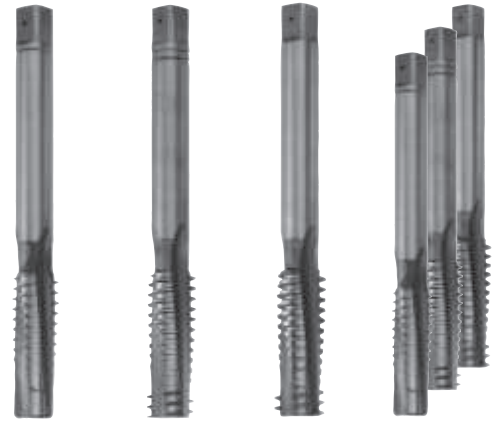
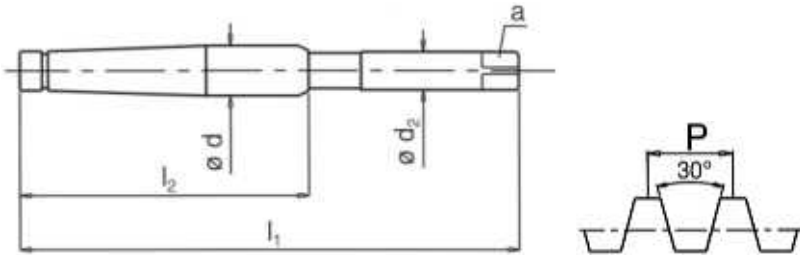

Katalog Nr. Bezeichnung	Catalogue No. Name		121 001 Hahnreiter Nr. 1	121 002 Hahnreiter Nr. 2	121 003 Hahnreiter 7H	121 000 Hahnreiter 7H
Toleranz Anschnittform Anschnittlänge, Gang für Bohrungsart	Tolerance Chamfer form Chamfer length, threads For holes		für Durchgangsgewinde bis max. 3 x d <sub>1</sub> for through holes up to max. 3 x d <sub>1</sub>			
hauptsächliches Einsatzgebiet Zerspanungsgruppe, siehe Ausklappseite links	Main use Machinability-group, See folder left page		alle gut spanbaren Materialien bis 800 N/mm <sup>2</sup> all free machining materials up to 800 N/mm <sup>2</sup>			
Ausführung	Variation		Vorschneider Taper	Mittelschneider Second	Fertigschneider Bottoming	Satz à 3 Stück Set of 3 pc.
Oberfläche	Surface		Verfügbarkeit Availability			
d P mm	Code	l <sub>1</sub>	l <sub>2</sub>	d <sub>2</sub>	a	
Tr 10	x 2 102	90	35	7,0	5,5	8,20
Tr 12	x 3 123	110	45	8,0	6,2	9,25
Tr 14	x 3 143	130	45	10,0	8,0	11,25
Tr 16	x 4 164	140	55	11,0	9,0	12,25
Tr 18	x 4 184	150	55	12,0	9,0	14,25
Tr 20	x 4 204	160	55	15,0	12,0	16,25
Tr 22	x 5 225	180	70	16,0	12,0	17,25
Tr 24	x 5 245	190	70	18,0	14,5	19,25
Tr 26	x 5 265	210	70	20,0	16,0	21,25
Tr 28	x 5 285	220	70	22,0	18,0	23,25
Tr 30	x 6 306	240	85	22,0	18,0	24,25
Tr 32	x 6 326	255	85	25,0	20,0	26,25
Tr 36	x 6 366	280	85	28,0	22,0	30,25
Tr 40	x 7 407	310	90	32,0	24,0	33,50

x = ab Lager, Zwischenverkauf vorbehalten  
o = nur solange Lagervorrat vorhanden  
x = normally ex stock  
o = available while stocks last

Tr



		121 011 Hahnreiter LH Nr. 1	121 012 Hahnreiter LH Nr. 2	121 013 Hahnreiter LH 7H		121 010 Hahnreiter LH 7H			
		<b>für Durchgangsgewinde bis max. 3 x d<sub>1</sub> for through holes up to max. 3 x d<sub>1</sub></b>							
		alle gut spanbaren Materialien bis 800 N/mm <sup>2</sup> all free machining materials up to 800 N/mm <sup>2</sup>							
		Vorschneider Links Taper Left hand	Mittelschneider Links Second Left hand	Fertigschneider Links Bottoming Left hand		Satz à 3 Stück Links Set of 3 pc. Left hand			
d	P mm	Verfügbarkeit Availability							
Tr 10	x 2	x	x	x		x			
Tr 12	x 3	x	x	x		x			
Tr 14	x 3	x	x	x		x			
Tr 16	x 4	x	x	x		x			
Tr 18	x 4	x	x	x		x			
Tr 20	x 4	x	x	x		x			
Tr 22	x 5	x	x	x		x			
Tr 24	x 5	x	x	x		x			
Tr 26	x 5	x	x	x		x			
Tr 28	x 5	x	x	x		x			
Tr 30	x 6	x	x	x		x			
Tr 32	x 6	x	x	x		x			
Tr 36	x 6	x	x	x		x			
Tr 40	x 7	x	x	x		x			

x = ab Lager, Zwischenverkauf vorbehalten  
o = nur solange Lagervorrat vorhanden  
x = normally ex stock  
o = available while stocks last

Tr

Metrisches ISO Trapezgewinde, DIN 103

Baumaße Werksnorm, mit Vorschneidstufe

Metric ISO Trapezoidal Threads DIN 103

Dimensions manufacturer's standard, 2 steps

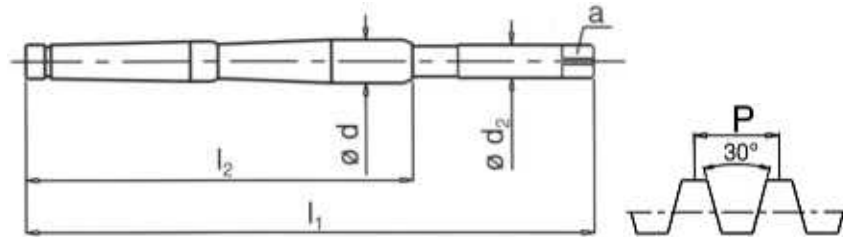

Katalog Nr. Bezeichnung	Catalogue No. Name	121 510 Stufex 5	121 511 Stufex 5 LH					
Toleranz	Tolerance	7H	7H					
Anschnittform	Chamfer form	für Durchgangsgewinde bis max. 2 x d <sub>1</sub> for through holes up to max. 2 x d <sub>1</sub>						
Anschnittlänge, Gang	Chamfer length, threads							
für Bohrungsart	For holes							
Sonderwerkstoff	Special material							
Zerspanungsgruppe, siehe Ausklappseite links	Machinability-group, See folder left page	<input type="checkbox"/> P <input type="checkbox"/> K <input type="checkbox"/> N <input type="checkbox"/>	<input type="checkbox"/> P <input type="checkbox"/> K <input type="checkbox"/> N <input type="checkbox"/>					
Oberfläche	Surface							
Ausführung	Variation		Links Left hand					
Typenbeschreibung ab Seite	Type description from page	T2	T2					
d	P	Code	l <sub>1</sub>	l <sub>2</sub>	d <sub>2</sub>	a		Verfügbarkeit Availability
	mm							
Tr 10	x 2	102	110	65	7,0	5,5	8,20	x
Tr 12	x 3	123	160	110	8,0	6,2	9,25	x
Tr 14	x 3	143	160	110	10,0	8,0	11,25	x
Tr 16	x 4	164	200	130	11,0	9,0	12,25	x
Tr 18	x 4	184	200	130	12,0	9,0	14,25	x
Tr 20	x 4	204	200	130	15,0	12,0	16,25	x
Tr 22	x 5	225	240	155	16,0	12,0	17,25	x
Tr 24	x 5	245	240	155	18,0	14,5	19,25	x
Tr 26	x 5	265	260	165	20,0	16,0	21,25	x
Tr 28	x 5	285	270	170	22,0	18,0	23,25	x
Tr 30	x 6	306	290	190	22,0	18,0	24,25	x
Tr 32	x 6	326	300	190	25,0	20,0	26,25	x
Tr 36	x 6	366	320	200	28,0	22,0	30,25	x
Tr 40	x 7	407	390	250	32,0	24,0	33,50	x

x = ab Lager, Zwischenverkauf vorbehalten  
o = nur solange Lagervorrat vorhanden  
x = normally ex stock  
o = available while stocks last

Tr

Metrisches ISO Trapezgewinde, DIN 103

Baumaße Werknorm

Metric ISO Trapezoidal Threads DIN 103

Dimensions manufacturer's standard

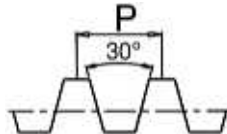
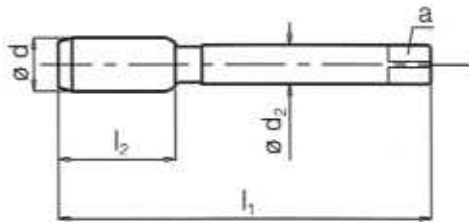

Katalog Nr. Bezeichnung	Catalogue No. Name		121 600 Automat MS	121 610 Automat MS LH						
Toleranz	Tolerance		7H	7H						
Anschnittform	Chamfer form		E	E						
Anschnittlänge, Gang	Chamfer length, threads		1,5-2	1,5-2						
für Bohrungsart	For holes									
Sonderwerkstoff	Special material		Messing Brass 3.21	Messing Brass 3.21						
Zerspanungsgruppe, siehe Ausklappseite links	Machinability-group, See folder left page		<input type="checkbox"/> <input type="checkbox"/> <input type="checkbox"/> <input checked="" type="checkbox"/> <input type="checkbox"/>	<input type="checkbox"/> <input type="checkbox"/> <input checked="" type="checkbox"/> <input type="checkbox"/>						
Oberfläche	Surface									
Ausführung	Variation			Links Left hand						
Typenbeschreibung ab Seite	Type description from page		T2	T2						
d	P	Code	l <sub>1</sub>	l <sub>2</sub>	d <sub>2</sub>	a		Verfügbarkeit Availability		
	mm									
Tr 8	x 1,5	0815	70	22	8,0	6,2	6,60		x	
Tr 8	x 2	082	70	22	8,0	6,2	6,20		x	
Tr 9	x 1,5	0915	70	22	8,0	6,2	7,60		x	x
Tr 9	x 2	092	70	22	8,0	6,2	7,20		x	x
Tr 10	x 1,5	1015	70	22	8,0	6,2	8,60		x	x
Tr 10	x 2	102	70	22	8,0	6,2	8,20		x	x
Tr 10	x 3*	103	70	22	8,0	6,2	7,50		x	x
Tr 11	x 2	112	70	22	9,0	7,0	9,20		x	
Tr 11	x 3	113	70	22	9,0	7,0	8,25		x	
Tr 12	x 2	122	70	22	9,0	7,0	10,20		x	x
Tr 12	x 3	123	70	22	9,0	7,0	9,25		x	x
Tr 14	x 2	142	70	25	10,0	8,0	12,20		x	
Tr 14	x 3	143	70	25	10,0	8,0	11,25		x	
Tr 14	x 4*	144	70	25	10,0	8,0	10,50		x	
Tr 16	x 2	162	70	25	12,0	9,0	14,20		x	x
Tr 16	x 4	164	70	25	12,0	9,0	12,25		x	x
Tr 18	x 2	182	70	28	12,0	9,0	16,20		x	
Tr 18	x 4	184	70	28	12,0	9,0	14,25		x	
Tr 20	x 2	202	70	28	16,0 (15,0)**	12,0	18,20		x	
Tr 20	x 4	204	70	28	16,0 (15,0)**	12,0	16,25		x	
Tr 22	x 3	223	70	30	18,0	14,5	19,25		x	
Tr 24	x 3	243	70	30	18,0	14,5	21,25		x	
Tr 26	x 3	263	70	30	18,0	14,5	23,25		x	
Tr 28	x 3	283	70	30	18,0	14,5	25,25		x	
Tr 30	x 3	303	70	30	18,0	14,5	27,25		x	

\* DIN Profil

\* Thread profile accord. to DIN

\*\*solange Lagervorrat liefern wir mit Schaft Ø 15,0

\*\*as long as available we will send shank Ø 15,0

x = ab Lager, Zwischenverkauf vorbehalten

o = nur solange Lagervorrat vorhanden

x = normally ex stock

o = available while stocks las

## Baumaße Werksnorm

Dimensions manufacturer's standard

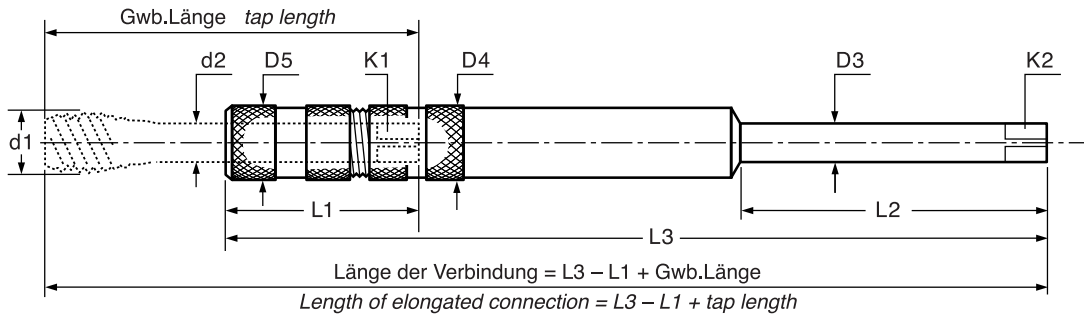

Katalog Nr.	Baumaße Gewindebohrer		Baumaße Verlängerung								100 100	100 101
Bezeichnung	tap dimensions		elongation dimensions								Hahnreiter	Hahnreiter
Ausführung	Variation										kurz	lang
											short	long
Code	DIN 371	DIN 376	Schaft-Ø	Vierkt.	Einspannlänge	Schaft-Ø	Vierkant	größter Ø	Schaftlänge	Ges.Länge	Verfügbarkeit	
	d1	d1	shank-Ø	square	chuck-length	shank-Ø	square	biggest Ø	shank length	total length	Availability	
	d1	d1	d2	K1	L1	D3	K2	D4/D5	L2	L3		
02	M 2 - M 2,6	M 4	2,8	2,1	22	6,0	4,9	6,1	60	130	x	
03	M 3	M 4,5 - M 5	3,5	2,7	23	6,0	4,9	7,5	60	130	x	
04	M 4	M 6	4,5	3,4	23	6,0	4,9	8,4	60	130	x	
06	M 4,5 - M 6	M 8	6,0	4,9	26	7,0	5,5	12,1	60	130	x	
07	M 7	M 9 - M 10	7,0	5,5	26	7,0	5,5	12,1	60	130	x	
08	M 8	M 11	8,0	6,2	30	8,0	6,2	13,0	60	130	x	
09	M 9	M 12	9,0	7,0	31	9,0	7,0	15,0	60	130	x	
10	M 10	-	10,0	8,0	33	10,0	8,0	15,0	60	130	x	
14		M 14	11,0	9,0	36	11,0	9,0	18,0	90	130	x	
16		M 16	12,0	9,0	36	12,0	9,0	18,0	90	130	x	
18		M 18	14,0	11,0	46	14,0	11,0	22,0	90	200	x	
20		M 20	16,0	12,0	46	16,0	12,0	22,0	90	200	x	
22		M 22 - M 24	18,0	14,5	47	18,0	14,5	26,0	100	200	x	
27		M 27	20,0	16,0	52	20,0	16,0	28,0	100	200	x	
30		M 30	22,0	18,0	55	22,0	18,0	30,0	100	200	x	
33		M 33	25,0	20,0	56	25,0	20,0	35,0	100	200	x	
36		M 36	28,0	22,0	58	28,0	22,0	40,0	100	200	x	
02	M 2 - M 2,6	M 4	2,8	2,1	22	6,0	4,9	6,1	70	230		x
03	M 3	M 4,5 - M 5	3,5	2,7	23	6,0	4,9	7,5	70	230		x
04	M 4	M 6	4,5	3,4	23	6,0	4,9	8,4	70	230		x
06	M 4,5 - M 6	M 8	6,0	4,9	26	7,0	5,5	12,1	70	230		x
07	M 7	M 9 - M 10	7,0	5,5	26	7,0	5,5	12,1	70	230		x
08	M 8	M 11	8,0	6,2	30	8,0	6,2	13,0	80	230		x
09	M 9	M 12	9,0	7,0	31	9,0	7,0	15,0	80	230		x
10	M 10	-	10,0	8,0	33	10,0	8,0	15,0	80	230		x
14		M 14	11,0	9,0	36	11,0	9,0	18,0	90	230		x
16		M 16	12,0	9,0	36	12,0	9,0	18,0	90	230		x
18		M 18	14,0	11,0	46	14,0	11,0	22,0	90	330		x
20		M 20	16,0	12,0	46	16,0	12,0	22,0	90	330		x
22		M 22 - M 24	18,0	14,5	47	18,0	14,5	26,0	100	330		x
27		M 27	20,0	16,0	52	20,0	16,0	28,0	100	330		x
30		M 30	22,0	18,0	55	22,0	18,0	30,0	100	330		x
33		M 33	25,0	20,0	56	25,0	20,0	35,0	100	330		x
36		M 36	28,0	22,0	58	28,0	22,0	40,0	100	330		x

x = ab Lager, Zwischenverkauf vorbehalten  
o = nur solange Lagerbestand vorhanden  
x = normally ex stock  
o = available while stocks last

Baumaße Werksnorm, IKZ innere Kühlmittelzufuhr, axial  
Dimensions manufacturer's standard, internal coolant supply, axial

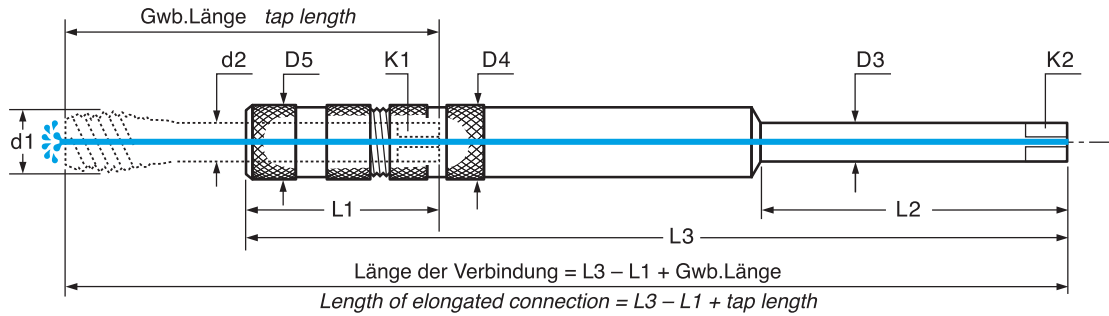

Verlängerungen / tap extensions

Katalog Nr. Bezeichnung	Baumaße Gewindebohrer tap dimensions		Baumaße Verlängerung elongation dimensions								Innere Kühlmittelzufuhr coolant supply internal	100 102 Hahnreiter	100 103 Hahnreiter
Ausführung	Variation										kurz short	lang long	
Code	DIN 371 d1	DIN 376 d1	Schaft-Ø shank-Ø d2	Vierkt. square K1	Einspannlänge chuck-length L1	Schaft-Ø shank-Ø D3	Vierkant square K2	größter Ø biggest Ø D4/D5	Schaftlänge shank length L2	Ges.Länge total length L3	Verfügbarkeit Availability		
02	M 2 - M 2,6	M 4	2,8	2,1	22	6,0	4,9	6,1	60	130	x		
03	M 3	M 4,5 - M 5	3,5	2,7	23	6,0	4,9	7,5	60	130	x		
04	M 4	M 6	4,5	3,4	23	6,0	4,9	8,4	60	130	x		
06	M 4,5 - M 6	M 8	6,0	4,9	26	7,0	5,5	12,1	60	130	x		
07	M 7	M 9 - M 10	7,0	5,5	26	7,0	5,5	12,1	60	130	x		
08	M 8	M 11	8,0	6,2	30	8,0	6,2	13,0	60	130	x		
09	M 9	M 12	9,0	7,0	31	9,0	7,0	15,0	60	130	x		
10	M 10	-	10,0	8,0	33	10,0	8,0	15,0	60	130	x		
14		M 14	11,0	9,0	36	11,0	9,0	18,0	90	130	x		
16		M 16	12,0	9,0	36	12,0	9,0	18,0	90	130	x		
18		M 18	14,0	11,0	46	14,0	11,0	22,0	90	200	x		
20		M 20	16,0	12,0	46	16,0	12,0	22,0	90	200	x		
22		M 22 - M 24	18,0	14,5	47	18,0	14,5	26,0	100	200	x		
27		M 27	20,0	16,0	52	20,0	16,0	28,0	100	200	x		
30		M 30	22,0	18,0	55	22,0	18,0	30,0	100	200	x		
33		M 33	25,0	20,0	56	25,0	20,0	35,0	100	200	x		
36		M 36	28,0	22,0	58	28,0	22,0	40,0	100	200	x		
06	M 4,5 - M 6	M 8	6,0	4,9	26	7,0	5,5	12,1	70	230		x	
07	M 7	M 9 - M 10	7,0	5,5	26	7,0	5,5	12,1	70	230		x	
08	M 8	M 11	8,0	6,2	30	8,0	6,2	13,0	80	230		x	
09	M 9	M 12	9,0	7,0	31	9,0	7,0	15,0	80	230		x	
10	M 10	-	10,0	8,0	33	10,0	8,0	15,0	80	230		x	
14		M 14	11,0	9,0	36	11,0	9,0	18,0	90	230		x	
16		M 16	12,0	9,0	36	12,0	9,0	18,0	90	230		x	
18		M 18	14,0	11,0	46	14,0	11,0	22,0	90	330		x	
20		M 20	16,0	12,0	46	16,0	12,0	22,0	90	330		x	
22		M 22 - M 24	18,0	14,5	47	18,0	14,5	26,0	100	330		x	
27		M 27	20,0	16,0	52	20,0	16,0	28,0	100	330		x	
30		M 30	22,0	18,0	55	22,0	18,0	30,0	100	330		x	
33		M 33	25,0	20,0	56	25,0	20,0	35,0	100	330		x	
36		M 36	28,0	22,0	58	28,0	22,0	40,0	100	330		x	

x = ab Lager, Zwischenverkauf vorbehalten  
o = nur solange Lagervorrat vorhanden  
x = normally ex stock  
o = available while stocks last





**VON DER KONSTRUKTION  
ZUM FERTIGEN WERKZEUG.**

***FROM DESIGN TO  
MANUFACTURE.***

**Können wir sonst noch  
was für Sie tun?**

Wir fertigen Sonderwerkzeuge nach Ihren Anforderungen im Durchmesserbereich von 1 bis 250 mm. Bitte nutzen Sie für Ihre Anfragen unseren Vordruck „Einsatzfallbeschreibung“ auf Seite T24.

Gerne unterstützen wir Sie bei der Suche nach der optimalen Lösung für Ihre Gewindefertigungsaufgabe.

***May we give you  
some more support?***

*We produce special tools in the range between  $\varnothing$  1 - 250 mm. Please use our form "Tapping - Specification of Application" for your enquiry.*

*We will be glad to support you looking for the best possible solution for your tapping problem!*

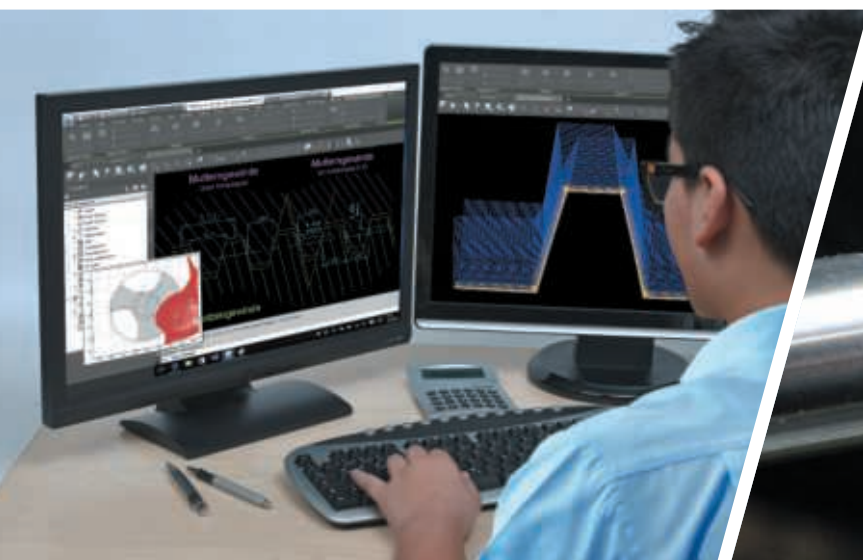

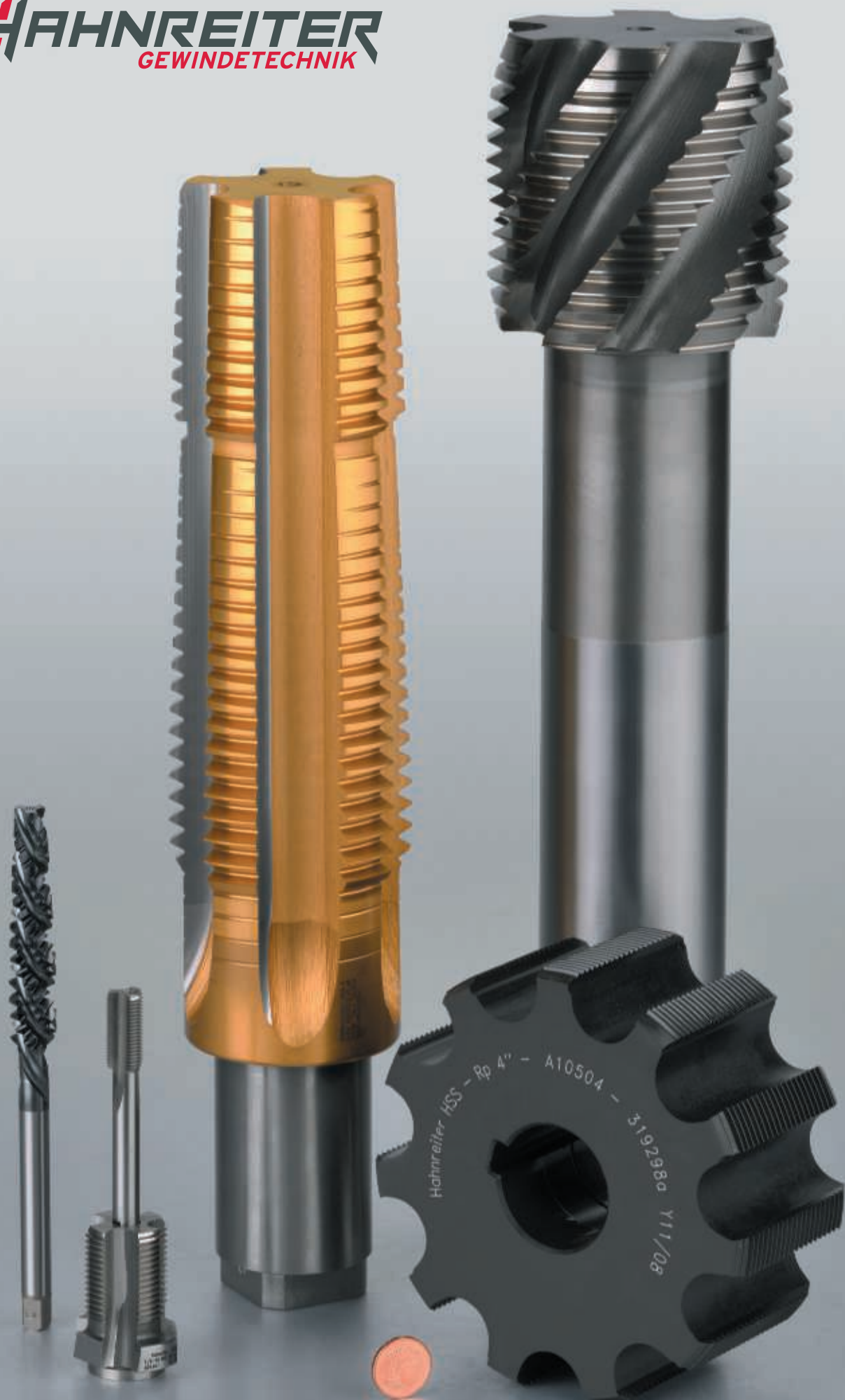

# Dies

		<i>Page</i>
<b>M</b>	<b>ISO Metric Coarse Threads, DIN 13</b>	
	<i>Dies</i>	<b>S2 - S5</b>
	<i>Dies for automatic machines</i>	<b>S6 - S7</b>
	<i>Dies for automatic machines, with fixing holes</i>	<b>S8</b>
	<i>Dies for automatic machines, bell form</i>	<b>S9</b>
	<i>Dies for automatic machines, projection form</i>	<b>S10</b>
<b>MF</b>	<b>ISO Metric Fine Threads, DIN 13</b>	<b>S11 - S17</b>
<b>UNC</b>	<b>Unified Coarse Threads ANSI B 1.1</b>	<b>S18</b>
<b>UNF</b>	<b>Unified Fine Threads ANSI B 1.1</b>	<b>S19</b>
<b>G</b>	<b>Whitworth Pipe Threads DIN ISO 228</b>	
	<i>Dies</i>	<b>S20</b>
	<i>Dies for automatic machines, bell form</i>	<b>S21</b>
<b>R</b>	<b>Whitworth Pipe Threads DIN EN 10226, ISO 7, DIN 2999 (withdrawn), Taper 1 : 16</b>	<b>S22</b>
<b>NPT</b>	<b>American Taper Pipe Thread - Taper 1 : 16 accord. to ANSI B 1.20.1 "general purpose"</b>	<b>S23</b>
<b>NPTF</b>	<b>American Taper Pipe Thread - Taper 1 : 16 accord. to ANSI B 1.20.3 "dry sealing"</b>	<b>S24</b>
<b>Pg</b>	<b>Steel Conduit Thread, DIN 40430</b>	<b>S25</b>
<b>BSW</b>	<b>Whitworth Coarse Threads BS 84</b>	<b>S26</b>
<b>Tr</b>	<b>Metric ISO Trapezoidal Threads DIN 103</b>	<b>S27</b>
<b>Rd</b>	<b>Round Threads DIN 405</b>	<b>S28</b>
	<b>Special Dies</b>	<b>S29</b>

# Schneideisen

		Seite
<b>M</b>	<b>Metrisches ISO-Regelgewinde DIN 13</b>	
	Gewindeschneideisen	S2 - S5
	Automaten-Gewindeschneideisen	S6 - S7
	Automaten-Gewindeschneideisen, mit Aufschraubblöchern	S8
	Automaten-Gewindeschneideisen, Glockenform	S9
	Automaten-Gewindeschneideisen, mit Vorbau	S10
<b>MF</b>	<b>Metrisches ISO Feingewinde DIN 13</b>	S11 - S17
<b>UNC</b>	<b>Unified Grobgewinde ANSI B 1.1</b>	S18
<b>UNF</b>	<b>Unified Feingewinde ANSI B 1.1</b>	S19
<b>G</b>	<b>Whitworth Rohrgewinde DIN ISO 228</b>	
	Gewindeschneideisen	S20
	Automaten-Gewindeschneideisen, Glockenform	S21
<b>R</b>	<b>Whitworth Rohrgewinde DIN EN 10226, ISO 7, DIN 2999 (zurückgezogen), Konus 1 : 16</b>	S22
<b>NPT</b>	<b>Amerikanisches Kegeliges Rohrgewinde - Konus 1 : 16 nach ANSI B 1.20.1 "allg. Verwendung"</b>	S23
<b>NPTF</b>	<b>Amerikanisches Kegeliges Rohrgewinde - Konus 1 : 16 nach ANSI B 1.20.3 "trocken dichtend"</b>	S24
<b>Pg</b>	<b>Stahlpanzerrohr-Gewinde, DIN 40430</b>	S25
<b>BSW</b>	<b>Whitworth Grobgewinde, BS 84</b>	S26
<b>Tr</b>	<b>Metrisches ISO Trapezgewinde, DIN 103</b>	S27
<b>Rd</b>	<b>Rundgewinde DIN 405</b>	S28
	<b>Sonder-Schneideisen</b>	S29

M

Metrisches ISO Gewinde DIN 13

Baumaße DIN-EN 22568

Form B, geschlossen, mit Schälanschnitt ab M 3

ISO metric screw Threads, DIN 13

Dimensions DIN-EN 22568

Form B, solid, spiral pointed from M 3

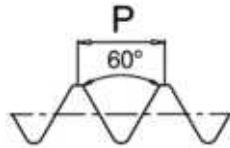
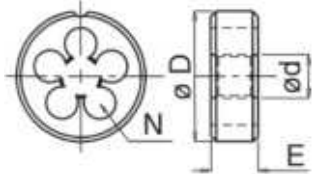

Katalog Nr. Bezeichnung	Catalogue No. Name	210 000 Hahnreiter	210 001 Hahnreiter GL	210 002 Hahnreiter LH	210 010 Hahnreiter 6e	210 011 Hahnreiter 6e GL				
Material	Material	HSS	HSS	HSS	HSS	HSS				
Toleranz	Tolerance	6g	6g	6g	6e	6e				
Anschnittlänge, Gang	Chamfer length, threads	1,75	1,75	1,75	1,75	1,75				
Sonderwerkstoff	Special material									
Zerspanungsgruppe, siehe Ausklappseite links	Machinability-group, See folder left page									
Oberfläche	Surface									
Ausführung	Variation		geläppt	Links	Abmaß	Abmaß				
			lapped	Left hand	Undersize	Undersize lapped				
d	P	Code	D x E	N	Dreh-Ø / Turning-Ø		Verfügbarkeit			
	mm		mm		6g	6e	Availability			
M 1	0,25	01	16 x 5	3	0,97	0,92	x		□	
M 1,1	0,25	011	16 x 5	3	1,07	1,02	x			
M 1,2	0,25	012	16 x 5	3	1,17	1,12	x		□	
M 1,4	0,3	014	16 x 5	3	1,36	1,31	x		□	
M 1,6	0,35	016	16 x 5	3	1,54	1,51	x		□	
M 1,7*	0,35	017	16 x 5	3	1,64	1,61	x		□	
M 1,8	0,35	018	16 x 5	3	1,74	1,71	x		□	
M 2	0,4	023	16 x 5	3	1,94	1,90	x	x		
M 2	0,4	024	16 x 5	4	1,94	1,90			x	x
M 2,2	0,45	0223	16 x 5	3	2,13	2,10	x	x	□	
M 2,2	0,45	0224	16 x 5	4	2,13	2,10				
M 2,3*	0,4	0233	16 x 5	3	2,24	2,20	x	x		
M 2,3*	0,4	0234	16 x 5	4	2,24	2,20				
M 2,5	0,45	0253	16 x 5	3	2,43	2,40	x	x		
M 2,5	0,45	0254	16 x 5	4	2,43	2,40			□	x
M 2,6*	0,45	0263	16 x 5	3	2,53	2,50	x	x		
M 2,6*	0,45	0264	16 x 5	4	2,53	2,50			□	
M 3	0,5	033	20 x 5	3	2,92	2,89	x	x		
M 3	0,5	034	20 x 5	4	2,92	2,89			x	x
M 3	0,5	035	20 x 5	5	2,92	2,89				
M 3,5	0,6	0353	20 x 5	3	3,41	3,38	x	x		
M 3,5	0,6	0354	20 x 5	4	3,41	3,38			x	x
M 4	0,7	043	20 x 5	3	3,91	3,87	x	x		
M 4	0,7	044	20 x 5	4	3,91	3,87			x	x
M 4	0,7	0445	20 x 5	5	3,91	3,87				
M 4,5	0,75	045	20 x 7	4	4,41	4,37	x	x		
M 5	0,8	05	20 x 7	4	4,90	4,86	x	x	x	x
M 5	0,8	055	20 x 7	5	4,90	4,86				
M 6	1	06	20 x 7	4	5,88	5,85	x	x	x	x
M 6	1	065	20 x 7	5	5,88	5,85				
M 7	1	07	25 x 9	4	6,88	6,85	x	x	x	x
M 8	1,25	08	25 x 9	4	7,87	7,83	x	x	x	x
M 8	1,25	085	25 x 9	5	7,87	7,83			□	□
M 9	1,25	09	25 x 9	4	8,86	8,83	x	x	□	
M 9	1,25	095	25 x 9	5	8,86	8,83				

\* DIN Profil  
\* Thread profile accord. to DIN

Fortsetzung Seite S4  
To be continued on page S4

x = ab Lager, Zwischenverkauf vorbehalten  
x = normally ex stock

Bis einschl. M 1,4 Toleranz 6h  
up to M 1,4 incl. tolerance 6h

Dreh-Ø = Empfehlung, Grenzmaße siehe Norm  
Turning-Ø = Recommendation. Limits see standard

□ = Verfügbar auf Anfrage  
□ = available on request



M

Metrisches ISO Gewinde DIN 13

Baumaße DIN-EN 22568

Form B, geschlossen, mit Schälanschnitt ab M 3

ISO metric screw Threads, DIN 13

Dimensions DIN-EN 22568

Form B, solid, spiral pointed from M 3

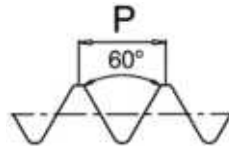
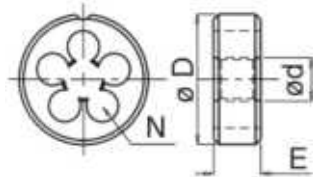

Katalog Nr. Bezeichnung	Catalogue No. Name	210 008 Hahnreiter 70	210 020 Hahnreiter MS	210 007 Standfest	210 005 Nirofix	210 006 Nirofix 6e		
Material	Material	HSS	HSS	HSS-EP	HSS-EP	HSS-EP		
Toleranz	Tolerance	6g	6g	6g	6g	6e		
Anschnittlänge, Gang	Chamfer length, threads	1,25	1,25	2,25	2	2		
Sonderwerkstoff	Special material		Messing Brass	für alle Stähle for all steels	rostfreie Stähle Stainless steels	rostfreie Stähle Stainless steels		
Zerspanungsgruppe, siehe Ausklappseite links	Machinability-group, See folder left page		3.21	1.1 - 1.10 4.15 / 4.16	1.9.4 / 1.9.5	1.9.4 / 1.9.5		
Oberfläche	Surface			Nit	Nit	Nit		
Ausführung	Variation	kurzer Anschnitt  short chamfer	geläppt  lapped	langer Anschnitt verlängerte Standzeit long chamfer increased tool life	geläppt  lapped	geläppt  lapped		
d	P mm	Code	D x E mm	N	Dreh-Ø / Turning-Ø 6g 6e		Verfügbarkeit Availability	
M 1	0,25	01	16 x 5	3				
M 1,1	0,25	011	16 x 5	3				
M 1,2	0,25	012	16 x 5	3				
M 1,4	0,3	014	16 x 5	3				
M 1,6	0,35	016	16 x 5	3				
M 1,7*	0,35	017	16 x 5	3				
M 1,8	0,35	018	16 x 5	3				
M 2	0,4	0231	16 x 3,5	4				x
M 2	0,4	023	16 x 5	3				
M 2	0,4	024	16 x 5	4				
M 2,2	0,45	0223	16 x 5	3	□			
M 2,2	0,45	0224	16 x 5	4				
M 2,3*	0,4	0233	16 x 5	3				
M 2,3*	0,4	0234	16 x 5	4				
M 2,5	0,45	0253	16 x 5	3				
M 2,5	0,45	0254	16 x 5	4				
M 2,6*	0,45	0263	16 x 5	3				
M 2,6*	0,45	0264	16 x 5	4				
M 3	0,5	033	20 x 5	3				
M 3	0,5	034	20 x 5	4				
M 3	0,5	035	20 x 5	5				
M 3,5	0,6	0354	20 x 5	4				
M 4	0,7	043	20 x 5	3				
M 4	0,7	044	20 x 5	4				
M 4	0,7	045	20 x 5	5				
M 4,5	0,75	045	20 x 7	4				
M 5	0,8	05	20 x 7	4				
M 5	0,8	055	20 x 7	5				
M 6	1	06	20 x 7	4				
M 6	1	065	20 x 7	5				
M 7	1	07	25 x 9	4				
M 8	1,25	08	25 x 9	4				
M 8	1,25	085	25 x 9	5				
M 8	1,25	086	25 x 9	6				
M 9	1,25	095	25 x 9	5				

\* DIN Profil  
\* Thread profile accord. to DIN

Fortsetzung Seite S5  
To be continued on page S5

x = ab Lager, Zwischenverkauf vorbehalten  
x = normally ex stock

Bis einschl. M 1,4 Toleranz 6h  
up to M 1,4 incl. tolerance 6h

Dreh-Ø = Empfehlung, Grenzmaße siehe Norm  
Turning-Ø = Recommendation. Limits see standard

□ = Verfügbar auf Anfrage  
□ = available on request



M

Metrisches ISO Gewinde DIN 13

Baumaße DIN-EN 22568

Form B, geschlossen, mit Schälanschnitt ab M 3

ISO metric screw Threads, DIN 13

Dimensions DIN-EN 22568

Form B, solid, spiral pointed from M 3

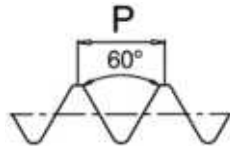
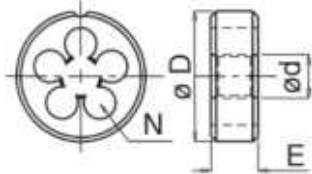

Katalog Nr. Bezeichnung	Catalogue No. Name	210 000 Hahnreiter	210 001 Hahnreiter GL	210 002 Hahnreiter LH	210 010 Hahnreiter 6e	210 011 Hahnreiter 6e GL
Material	Material	HSS	HSS	HSS	HSS	HSS
Toleranz	Tolerance	6g	6g	6g	6e	6e
Anschnittlänge, Gang	Chamfer length, threads	1,75	1,75	1,75	1,75	1,75
Sonderwerkstoff	Special material					
Zerspanungsgruppe, siehe Ausklappseite links	Machinability-group, See folder left page					
Oberfläche	Surface					
Ausführung	Variation		geläppt	Links	Abmaß	Abmaß geläppt
			lapped	Left hand	Undersize	Undersize lapped
d	P mm	Code	D x E mm	N	Dreh-Ø / Turning-Ø 6g 6e	Verfügbarkeit Availability
M 10	1,5	104	30 x 11	4	9,85 9,81	x x x x x
M 10	1,5	105	30 x 11	5	9,85 9,81	
M 10	1,5	106	30 x 11	6	9,85 9,81	
M 11	1,5	11	30 x 11	4	10,85 10,81	x x □
M 11	1,5	115	30 x 11	5	10,85 10,81	
M 12	1,75	124	38 x 14	4	11,83 11,80	x x x x x
M 12	1,75	125	38 x 14	5	11,83 11,80	
M 12	1,75	126	38 x 14	6	11,83 11,80	
M 14	2	144	38 x 14	4	13,82 13,79	x x x □ □
M 14	2	145	38 x 14	5	13,82 13,79	
M 16	2	164	45 x 18	4	15,82 15,79	x x x x x
M 16	2	165	45 x 18	5	15,82 15,79	
M 16	2	166	45 x 18	6	15,82 15,79	
M 18	2,5	18	45 x 18	5	17,79 17,75	x x x
M 20	2,5	20	45 x 18	5	19,79 19,75	x x x □ □
M 20	2,5	206	45 x 18	6	19,79 19,75	
M 22	2,5	22	55 x 22	5	21,79 21,75	x x x
M 24	3	24	55 x 22	5	23,77 23,73	x x x
M 24	3	246	55 x 22	6	23,77 23,73	
M 27	3	27	65 x 25	5	26,77 26,73	x x x
M 27	3	276	65 x 25	6	26,77 26,73	
M 30	3,5	30	65 x 25	5	29,73 29,70	x x x
M 30	3,5	306	65 x 25	6	29,73 29,70	
M 33	3,5	33	65 x 25	6	32,73 32,70	x x □
M 36	4	36	65 x 25	7	35,70 35,66	x x □
M 39	4	39	75 x 30	6	38,70 38,66	x x x
M 42	4,5	42	75 x 30	7	41,68 41,65	x x □
M 45	4,5	45	90 x 36	7	44,68 44,65	x x
M 48	5	48	90 x 36	7	47,66 47,62	x x
M 52	5	52	90 x 36	7	51,66 51,62	x x
M 56	5,5	56	105 x 36	7	55,85 55,81	□ □
M 60	5,5	60	105 x 36	8	59,85 59,81	□ □
M 64	6	64	105 x 36	8	63,85 63,81	□ □

\* DIN Profil

\* Thread profile accord. to DIN

x = ab Lager, Zwischenverkauf vorbehalten

x = normally ex stock

Bis einschl. M 1,4 Toleranz 6h  
up to M 1,4 incl. tolerance 6h

Dreh-Ø = Empfehlung, Grenzmaße siehe Norm  
Turning-Ø = Recommendation. Limits see standard

□=Verfügbar auf Anfrage  
□=available on request

M

Metrisches ISO Gewinde DIN 13

Baumaße DIN-EN 22568

Form B, geschlossen, mit Schälanschnitt ab M 3

ISO metric screw Threads, DIN 13

Dimensions DIN-EN 22568

Form B, solid, spiral pointed from M 3

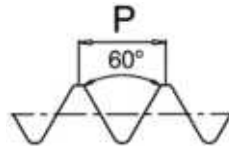
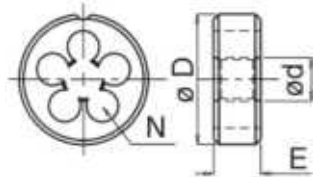

Katalog Nr. Bezeichnung	Catalogue No. Name	210 008 Hahnreiter 70	210 020 Hahnreiter MS	210 007 Standfest	210 005 Nirofix	210 006 Nirofix 6e		
Material	Material	HSS	HSS	HSS-EP	HSS-EP	HSS-EP		
Toleranz	Tolerance	6g	6g	6g	6g	6e		
Anschnittlänge, Gang	Chamfer length, threads	1,25	1,25	2,25	2	2		
Sonderwerkstoff	Special material		Messing Brass	für alle Stähle for all steels	rostfreie Stähle Stainless steels	rostfreie Stähle Stainless steels		
Zerspanungsgruppe, siehe Ausklappseite links	Machinability-group, See folder left page		3.21	1.1 - 1.10 4.15 / 4.16	1.9.4 / 1.9.5	1.9.4 / 1.9.5		
Oberfläche	Surface			Nit	Nit	Nit		
Ausführung	Variation	kurzer Anschnitt  short chamfer	geläppt  lapped	langer Anschnitt verlängerte Standzeit long chamfer increased tool life	geläppt  lapped	geläppt  lapped		
d	P mm	Code	D x E mm	N	Dreh-Ø / Turning-Ø 6g 6e		Verfügbarkeit Availability	
M 10	1,5	104	30 x 11	4	9,85	9,81		
M 10	1,5	105	30 x 11	5	9,85	9,81	x	
M 10	1,5	106	30 x 11	6	9,85	9,81		x
M 11	1,5	11	30 x 11	4	10,85	10,81		
M 11	1,5	111	30 x 11	5	10,85	10,81		
M 12	1,75	124	38 x 14	4	11,83	11,80		
M 12	1,75	125	38 x 14	5	11,83	11,80	□	
M 12	1,75	126	38 x 14	6	11,83	11,80		x
M 14	2	144	38 x 14	4	13,82	13,79		
M 14	2	145	38 x 14	5	13,82	13,79		x
M 16	2	164	45 x 18	4	15,82	15,79		
M 16	2	165	45 x 18	5	15,82	15,79		x
M 16	2	166	45 x 18	6	15,82	15,79		x
M 18	2,5	18	45 x 18	5	17,79	17,75		x
M 20	2,5	20	45 x 18	5	19,79	19,75		x
M 20	2,5	206	45 x 18	6	19,79	19,75		x
M 22	2,5	22	55 x 22	6	21,79	21,75		x
M 24	3	24	55 x 22	5	23,77	23,73		
M 24	3	246	55 x 22	6	23,77	23,73		x
M 27	3	27	65 x 25	5	26,77	26,73		
M 27	3	276	65 x 25	6	26,77	26,73		x
M 30	3,5	30	65 x 25	5	29,73	29,70		
M 30	3,5	306	65 x 25	6	29,73	29,70		□
M 33	3,5	33	65 x 25	6	32,73	32,70		□
M 36	4	36	65 x 25	7	35,70	35,66		□
M 39	4	39	75 x 30	6	38,70	38,66		
M 42	4,5	42	75 x 30	7	41,68	41,65		
M 45	4,5	45	90 x 36	7	44,68	44,65		
M 48	5	48	90 x 36	7	47,66	47,62		
M 52	5	52	90 x 36	7	51,66	51,62		
M 56	5,5	56	105 x 36	7	55,85	55,81		
M 60	5,5	60	105 x 36	8	59,85	59,81		
M 64	6	64	105 x 36	8	63,85	63,81		

\* DIN Profil  
\* Thread profile accord. to DIN

x = ab Lager, Zwischenverkauf vorbehalten  
x = normally ex stock

Bis einschl. M 1,4 Toleranz 6h  
up to M 1,4 incl. tolerance 6h

Dreh-Ø = Empfehlung, Grenzmaße siehe Norm  
Turning-Ø = Recommendation. Limits see standard

□ = Verfügbar auf Anfrage  
□ = available on request

## M

### Metrisches ISO Gewinde DIN 13

Baumaße DIN-EN 22568

Form B, geschlossen, mit Schälanschnitt ab M 3

### ISO metric screw Threads, DIN 13

Dimensions DIN-EN 22568

Form B, solid, spiral pointed from M 3

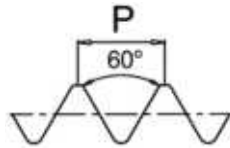
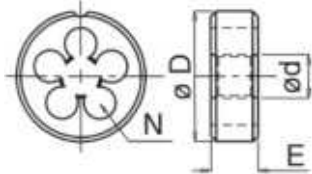

Katalog Nr. Bezeichnung	Catalogue No. Name	210 101 Hahnreiter GL	210 110 Hahnreiter 6e GL	210 120 Hahnreiter MS	210 105 Nirofix	210 106 Nirofix 6e		
Material	Material	HSS	HSS	HSS	HSS-EP	HSS-EP		
Toleranz	Tolerance	6g	6e	6g	6g	6e		
Anschnittlänge, Gang	Chamfer length, threads	1,75	1,75	1,25	2	2		
Sonderwerkstoff	Special material			Messing Brass	rostfreie Stähle Stainless steels	rostfreie Stähle Stainless steels		
Zerspanungsgruppe, siehe Ausklappseite links	Machinability-group, See folder left page			3.21	1.9.4 / 1.9.5	1.9.4 / 1.9.5		
Oberfläche	Surface				Nit	Nit		
Ausführung	Variation	geläppt	Abmaß geläppt	geläppt	geläppt	geläppt		
		<i>lapped</i>	<i>Undersize lapped</i>	<i>lapped</i>	<i>lapped</i>	<i>lapped</i>		
d	P	Code	D x E	N	Dreh-Ø / Turning-Ø		Verfügbarkeit	
	mm		mm		6g	6e	Availability	
M 1	0,25	01	16 x 2	3	0,97	0,92	□	□
M 1,2	0,25	012	16 x 2	3	1,17	1,12	□	□
M 1,4	0,3	0141	12 x 2,6	4	1,36	1,31	□	
M 1,4	0,3	0142	16 x 2,6	4	1,36	1,31	x	x
M 1,6	0,35	0161	12 x 2,6	4	1,54	1,51	□	
M 1,6	0,35	0162	16 x 2,6	4	1,54	1,51	x	x
M 1,7*	0,35	0171	12 x 2,6	4	1,64	1,61	□	
M 1,7*	0,35	0172	16 x 2,6	4	1,64	1,61	□	x
M 1,8	0,35	018	16 x 2,6	4	1,74	1,71	□	□
M 2	0,4	021	12 x 3,5	4	1,94	1,90	x	
M 2	0,4	023	16 x 3,5	4	1,94	1,90		x
M 2	0,4	024	16 x 5	4	1,94	1,90	x	x
M 2,2	0,45	0221	16 x 3,5	4	2,13	2,10		□
M 2,2	0,45	0222	16 x 5	4	2,13	2,10		
M 2,3*	0,4	0231	12 x 3	4	2,24	2,20		
M 2,3*	0,4	0232	16 x 3,5	4	2,24	2,20		x
M 2,3*	0,4	0233	16 x 5	4	2,24	2,20		
M 2,5	0,45	0251	12 x 3,5	4	2,43	2,40	□	
M 2,5	0,45	0253	16 x 5	4	2,43	2,40	x	x
M 2,6*	0,45	0261	12 x 3,5	4	2,53	2,50		
M 2,6*	0,45	0263	16 x 5	4	2,53	2,50	x	x
M 3	0,5	031	12 x 4	4	2,92	2,89	x	□
M 3	0,5	033	16 x 5	4	2,92	2,89	x	x
M 3	0,5	034	20 x 5	4	2,92	2,89	□	x
M 3,5	0,6	0352	16 x 5	4	3,41	3,38	x	□
M 3,5	0,6	0353	20 x 5	4	3,41	3,38	x	x
M 4	0,7	041	16 x 5	4	3,91	3,87	x	x
M 4	0,7	042	20 x 5	4	3,91	3,87	x	x
M 4	0,7	043	20 x 5	5	3,91	3,87	x	□
M 5	0,8	051	16 x 5	4	4,90	4,86	x	x
M 5	0,8	052	20 x 7	4	4,90	4,86	x	x
M 5	0,8	053	20 x 7	5	4,90	4,86	□	x
M 6	1	061	16 x 5	5	5,88	5,85	x	□
M 6	1	062	20 x 7	4	5,88	5,85	x	x
M 6	1	063	20 x 7	5	5,88	5,85	x	x

\* DIN Profil

\* Thread profile accord. to DIN

Fortsetzung nächste Seite

Continued on next page

x = ab Lager, Zwischenverkauf vorbehalten

x = normally ex stock

Bis einschl. M 1,4 Toleranz 6h  
up to M 1,4 incl. tolerance 6h

Dreh-Ø = Empfehlung, Grenzmaße siehe Norm  
Turning-Ø = Recommendation. Limits see standard

□ = Verfügbar auf Anfrage  
□ = available on request

**M**

**Metrisches ISO Gewinde DIN 13**

Baumaße DIN-EN 22568

Form B, geschlossen, mit Schälanschnitt ab M 3

**ISO metric screw Threads, DIN 13**

*Dimensions DIN-EN 22568*

*Form B, solid, spiral pointed from M 3*

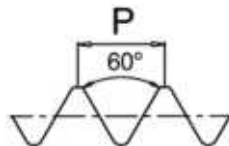
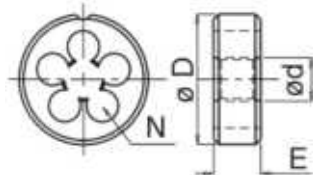

Katalog Nr. Bezeichnung	Catalogue No. Name	210 101 Hahnreiter GL	210 110 Hahnreiter 6e GL	210 120 Hahnreiter MS	210 105 Nirofix	210 106 Nirofix 6e
Material	Material	HSS	HSS	HSS	HSS-EP	HSS-EP
Toleranz	Tolerance	6g	6e	6g	6g	6e
Anschnittlänge, Gang	Chamfer length, threads	1,75	1,75	1,25	2	2
Sonderwerkstoff	Special material			Messing Brass	rostfreie Stähle Stainless steels	rostfreie Stähle Stainless steels
Zerspanungsgruppe, siehe Ausklappseite links	Machinability-group, See folder left page			3.21	1.9.4 / 1.9.5	1.9.4 / 1.9.5
Oberfläche	Surface				Nit	Nit
Ausführung	Variation	geläppt	Abmaß geläppt	geläppt	geläppt	geläppt
		<i>lapped</i>	<i>Undersize lapped</i>	<i>lapped</i>	<i>lapped</i>	<i>lapped</i>

d	P mm	Code	D x E mm	N	Dreh-Ø / Turning-Ø		Verfügbarkeit Availability					
					6g	6e						
M 7	1	07	20 x 7	5	6,88	6,85	□					
M 7	1	071	25 x 9	4	6,88	6,85			x	x		
M 8	1,25	081	20 x 7	5	7,87	7,83	x	□		x		□
M 8	1,25	082	25 x 9	4	7,87	7,83	x	x		x		
M 8	1,25	083	25 x 9	5	7,87	7,83	x	□		x		x
M 10	1,5	102	25 x 9	5	9,85	9,81	x			x		
M 10	1,5	103	30 x 11	5	9,85	9,81	x			x		x
M 10	1,5	104	30 x 11	4	9,85	9,81			x			
M 12	1,75	121	25 x 9	5	11,83	11,80	□					
M 12	1,75	122	30 x 11	5	11,83	11,80	□					
M 12	1,75	124	38 x 14	4	11,83	11,80	x	x	x			
M 12	1,75	123	38 x 14	5	11,83	11,80	x			x		x
M 14	2	14	38 x 14	5	13,82	13,79				x		
M 16	2	16	45 x 18	5	15,82	15,79	□			x		

\* DIN Profil  
 \* Thread profile accord. to DIN

x = ab Lager, Zwischenverkauf vorbehalten  
 x = normally ex stock

Bis einschl. M 1,4 Toleranz 6h  
 up to M 1,4 incl. tolerance 6h

Dreh-Ø = Empfehlung, Grenzmaße siehe Norm  
 Turning-Ø = Recommendation. Limits see standard

□ = Verfügbar auf Anfrage  
 □ = available on request

## M

### Metrisches ISO Gewinde DIN 13

Baumaße Werksnorm, mit Aufschraubblöchern

Form B, geschlossen, mit Schälanschnitt ab M 3

### ISO metric screw Threads, DIN 13

Dimensions manufacturer's standard, with fixing holes

Form B, solid, spiral pointed from M 3

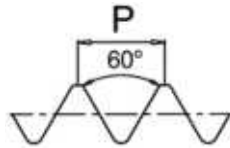
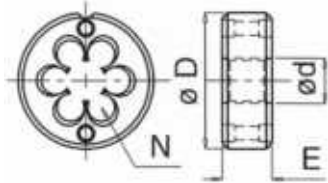

Katalog Nr. Bezeichnung	Catalogue No. Name	210 401 Hahnreiter GL	210 411 Hahnreiter 6e GL	210 420 Hahnreiter MS	210 414 Hahnreiter 6e MS	210 405 Nirofix						
Material	Material	HSS	HSS	HSS	HSS	HSS-EP						
Toleranz	Tolerance	6g	6e	6g	6e	6g						
Anschnittlänge, Gang	Chamfer length, threads	1,75	1,75	1,25	1,25	2						
Sonderwerkstoff	Special material			Messing Brass	Messing Brass	rostfreie Stähle Stainless steels						
Zerspanungsgruppe, siehe Ausklappseite links	Machinability-group, See folder left page			3.21	3.21	1.9.4 / 1.9.5						
Oberfläche	Surface					Nit						
Ausführung	Variation	geläppt	Abmaß geläppt	geläppt	Abmaß geläppt	geläppt						
		<i>lapped</i>	<i>Undersize lapped</i>	<i>lapped</i>	<i>Undersize lapped</i>	<i>lapped</i>						
d	P mm	Code	D x E mm	N	Dreh-Ø / Turning-Ø 6g 6e		Verfügbarkeit Availability					
M 1	0,25	01	16 x 2	3	0,97	0,92	□					
M 1,1	0,25	011	16 x 2	3	1,07	1,02	□					
M 1,2	0,25	012	16 x 2	3	1,17	1,12	□					
M 1,4	0,3	0142	16 x 2,6	4	1,36	1,31	x					
M 1,6	0,35	0162	16 x 2,6	4	1,54	1,51	x	□				
M 1,7*	0,35	0172	16 x 2,6	4	1,64	1,61	x					
M 1,8	0,35	018	16 x 2,6	4	1,74	1,71	□					
M 2	0,4	021	12 x 3,5	4	1,94	1,90	□					
M 2	0,4	022	16 x 3,5	4	1,94	1,90	x	□	□	□	□	
M 2,2	0,45	0221	16 x 3,5	4	2,13	2,10	□					
M 2,3*	0,4	0232	16 x 3,5	4	2,24	2,20	x					
M 2,5	0,45	0251	12 x 3,5	4	2,43	2,40	□					
M 2,5	0,45	0252	16 x 3,5	4	2,43	2,40	x	x	□	□	x	
M 2,6*	0,45	0262	16 x 3,5	4	2,53	2,50	x					
M 3	0,5	032	16 x 3,5	4	2,92	2,89	x	x	□	□	x	
M 3,5	0,6	0351	16 x 4	4	3,41	3,38	x	□			□	
M 4	0,7	041	16 x 5	4	3,91	3,87	x	x	□	□	x	
M 4	0,7	042	20 x 5	4	3,91	3,87	x	□			□	
M 4,5	0,75	045	20 x 7	4	4,41	4,37	□					
M 5	0,8	052	20 x 7	4	4,90	4,86	x	x	□	□	x	
M 6	1	062	20 x 7	4	5,88	5,85	x	x	□	□	x	
M 7	1	07	25 x 7	4	6,88	6,85	x	□				
M 8	1,25	082	25 x 9	4	7,87	7,83	x	x	□		x	
M 10	1,5	101	25 x 9	4	9,85	9,81	x					
M 10	1,5	104	30 x 11	6	9,85	9,81	x	x			□	
M 12	1,75	121	30 x 11	6	11,83	11,80	x					
M 12	1,75	122	35 x 12	6	11,83	11,80	□	□				
M 14	2	14	35 x 14	6	13,82	13,79	□					
M 16	2	16	45 x 18	6	15,82	15,79	□					

\* DIN Profil

\* Thread profile accord. to DIN

Bis einschl. M 1,4 Toleranz 6h  
up to M 1,4 incl. tolerance 6h

Dreh-Ø = Empfehlung, Grenzmaße siehe Norm  
Turning-Ø = Recommendation. Limits see standard

x = ab Lager, Zwischenverkauf vorbehalten

x = normally ex stock

□ = Verfügbar auf Anfrage

□ = available on request

M

Metrisches ISO Gewinde DIN 13

Baumaße Werknorm, **Glockenform**

Form B, geschlossen, mit Schälanschnitt ab M 3

**ISO metric screw Threads, DIN 13**

Dimensions manufacturer's standard, bell form

Form B, solid, spiral pointed from M 3

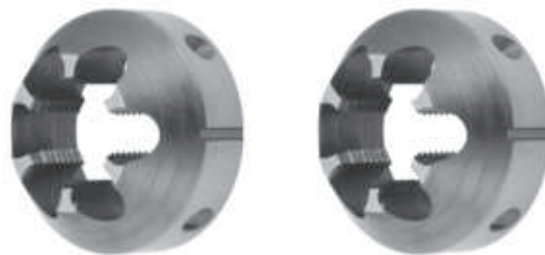
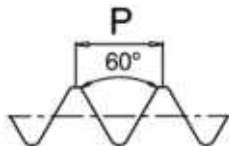
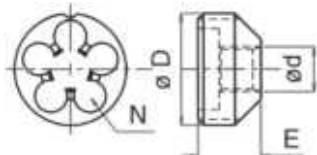

Katalog Nr. Bezeichnung	Catalogue No. Name	210 201 Hahnreiter GL	210 211 Hahnreiter 6e GL	210 220 Hahnreiter MS	210 214 Hahnreiter 6e MS	210 205 Nirofix
Material	Material	HSS	HSS	HSS	HSS	HSS-EP
Toleranz	Tolerance	6g	6e	6g	6e	6g
Anschnittlänge, Gang	Chamfer length, threads	1,75	1,75	1,25	1,25	2
Sonderwerkstoff	Special material			Messing Brass	Messing Brass	rostfreie Stähle Stainless steels
Zerspanungsgruppe, siehe Ausklappseite links	Machinability-group, See folder left page			3.21	3.21	1.9.4 / 1.9.5
Oberfläche	Surface					Nit
Ausführung	Variation	geläppt	Abmaß geläppt	geläppt	Abmaß geläppt	geläppt
		<i>lapped</i>	<i>Undersize lapped</i>	<i>lapped</i>	<i>Undersize lapped</i>	<i>lapped</i>

d	P mm	Code	D x E mm	N	Dreh-Ø / Turning-Ø		Verfügbarkeit Availability				
					6g	6e	210 201	210 211	210 220	210 214	210 205
M 2	0,4	02	16 x 8	4	1,94	1,90	x	□	□	□	□
M 2,2	0,45	022	16 x 8	4	2,13	2,10	□	□	□	□	□
M 2,3*	0,4	023	16 x 8	4	2,24	2,20	□	□	□	□	□
M 2,5	0,45	025	16 x 8	4	2,43	2,40	x	□	□	□	□
M 2,6*	0,45	026	16 x 8	4	2,53	2,50	□	□	□	□	□
M 3	0,5	031	16 x 8	4	2,92	2,89	x	x	□	□	x
M 3	0,5	032	20 x 9,5	4	2,92	2,89	□	□	□	□	□
M 3,5	0,6	035	16 x 9,5	4	3,41	3,38	□	□	□	□	□
M 4	0,7	041	16 x 9,5	4	3,91	3,87	x	x	□	□	x
M 4	0,7	043	20 x 9,5	4	3,91	3,87	x	□	□	□	□
M 4,5	0,75	045	16 x 9,5	4	4,41	4,37	□	□	□	□	□
M 5	0,8	051	16 x 9,5	4	4,90	4,86	x	x	□	□	□
M 5	0,8	053	20 x 9,5	4	4,90	4,86	x	□	□	□	□
M 6	1	061	16 x 9,5	4	5,88	5,85	x	□	□	□	□
M 6	1	062	20 x 9,5	4	5,88	5,85	x	□	□	□	□
M 7	1	07	25 x 14	4	6,88	6,85	□	□	□	□	□
M 8	1,25	081	25 x 14	5	7,87	7,83	x	□	□	□	□
M 10	1,5	101	25 x 14	5	9,85	9,81	□	□	□	□	□
M 12	1,75	12	30 x 18	5	11,83	11,80	□	□	□	□	□

\* DIN Profil  
\* Thread profile accord. to DIN

x = ab Lager, Zwischenverkauf vorbehalten  
x = normally ex stock

Bis einschl. M 1,4 Toleranz 6h  
up to M 1,4 incl. tolerance 6h

Dreh-Ø = Empfehlung, Grenzmaße siehe Norm  
Turning-Ø = Recommendation. Limits see standard

□ = Verfügbar auf Anfrage  
□ = available on request



M

Metrisches ISO Gewinde DIN 13

Baumaße Werksnorm, mit Vorbau

Form B, geschlossen, mit Schälanschnitt ab M 3

ISO metric screw Threads, DIN 13

Dimensions manufacturer's standard, projection form

Form B, solid, spiral pointed from M 3

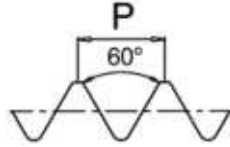
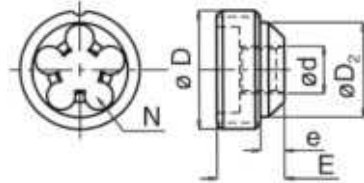

Katalog Nr. Bezeichnung	Catalogue No. Name		210 301 Hahnreiter GL		210 320 Hahnreiter MS					
Material	Material		HSS		HSS					
Toleranz	Tolerance		6g		6g					
Anschnittlänge, Gang	Chamfer length, threads		1,75		1,25					
Sonderwerkstoff	Special material				Messing Brass					
Zerspanungsgruppe, siehe Ausklappseite links	Machinability-group, See folder left page				3.21					
Oberfläche	Surface									
Ausführung	Variation		geläppt		geläppt					
			lapped		lapped					
d	P	Code	D x E	N	D2 x e	Dreh-Ø / Turning-Ø	Verfügbarkeit Availability			
	mm		mm		mm	6g 6e				
M 3	0,5	032	16 x 9,5	4	12,5 x 4,5	2,92 2,89		<input type="checkbox"/>		<input type="checkbox"/>
M 4	0,7	042	16 x 9,5	4	12,5 x 4,5	3,91 3,87		<input type="checkbox"/>		<input type="checkbox"/>
M 4	0,7	044	20 x 12	4	16 x 7	3,91 3,87		<input type="checkbox"/>		<input type="checkbox"/>
M 5	0,8	052	16 x 9,5	4	12,5 x 4,5	4,90 4,86				
M 5	0,8	054	20 x 12	4	16 x 5	4,90 4,86				
M 6	1	063	20 x 12	4	16 x 5	5,88 5,85		<input type="checkbox"/>		<input type="checkbox"/>
M 8	1,25	082	25 x 14	5	20 x 5	7,87 7,83		<input type="checkbox"/>		<input type="checkbox"/>
M 10	1,5	102	25 x 14	5	20 x 5	9,85 9,81		<input type="checkbox"/>		<input type="checkbox"/>
M 12	1,75	12	30 x 18	5	25 x 7	11,83 11,80				

\* DIN Profil  
\* Thread profile accord. to DIN

Bis einschl. M 1,4 Toleranz 6h  
up to M 1,4 incl. tolerance 6h

Dreh-Ø = Empfehlung, Grenzmaße siehe Norm  
Turning-Ø = Recommendation. Limits see standard

x = ab Lager, Zwischenverkauf vorbehalten  
x = normally ex stock

= Verfügbar auf Anfrage  
 = available on request

MF

Metrisches ISO Feingewinde DIN 13

Baumaße DIN-EN 22568

Form B, geschlossen, mit Schälanschnitt ab M 3

ISO Metric Fine Threads, DIN 13

Dimensions DIN-EN 22568

Form B, solid, spiral pointed from M 3

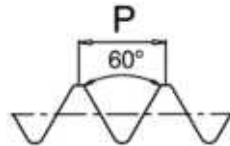
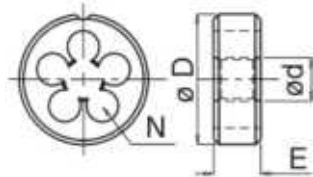

Katalog Nr. Bezeichnung	Catalogue No. Name				211 000 Hahnreiter	211 001 Hahnreiter GL	211 002 Hahnreiter LH	211 010 Hahnreiter 6e	211 011 Hahnreiter 6e GL
Material	Material				HSS	HSS	HSS	HSS	HSS
Toleranz	Tolerance				6g	6g	6g	6e	6e
Anschnittlänge, Gang	Chamfer length, threads				1,75	1,75	1,75	1,75	1,75
Sonderwerkstoff	Special material								
Zerspanungsgruppe, siehe Ausklappseite links	Machinability-group, See folder left page								
Oberfläche	Surface								
Ausführung	Variation					geläppt	Links	Abmaß	Abmaß geläppt
						lapped	Left hand	Undersize	Undersize lapped
d	P mm	Code	D x E mm	N	Dreh-Ø / Turning-Ø 6g 6e		Verfügbarkeit Availability		
M 2	x 0,25	02025	16 x 5	4	1,97	1,92			
M 2,2	x 0,25	022025	16 x 5	4	2,17	2,12	□		
M 2,5	x 0,35	025035	16 x 5	4	2,44	2,41	x	□	□
M 3	x 0,35	03035	20 x 5	4	2,94	2,91	x	□	□
M 3,5	x 0,35	035035	20 x 5	4	3,44	3,41	x	□	□
M 4	x 0,35	04035	20 x 5	4	3,94	3,91	x	□	□
M 4	x 0,5	0405	20 x 5	4	3,92	3,89	x	□	□
M 5	x 0,5	0505	20 x 5	4	4,92	4,89	x	x	x
M 6	x 0,5	0605	20 x 5	4	5,92	5,89	x	x	x
M 6	x 0,75	06075	20 x 7	4	5,90	5,87	x	x	x
M 7	x 0,75	07075	25 x 9	4	6,90	6,87	x	x	x
M 8	x 0,5	0805	25 x 9	5	7,92	7,89	x	x	x
M 8	x 0,75	08075	25 x 9	4	7,90	7,87	x	x	x
M 8	x 1	081	25 x 9	4	7,88	7,85	x	x	x
M 9	x 0,75	09075	25 x 9	5	8,90	8,87	x	□	
M 9	x 1	091	25 x 9	5	8,88	8,85	x	□	
M 10	x 0,5	1005	30 x 11	5	9,92	9,89	x	□	□
M 10	x 0,75	10075	30 x 11	5	9,90	9,87	x	x	x
M 10	x 1	101	30 x 11	5	9,88	9,85	x	x	x
M 10	x 1,25	10125	30 x 11	4	9,86	9,83	x	□	□
M 12	x 0,5	1205	38 x 10	5	11,92	11,89	x	□	
M 12	x 0,75	12075	38 x 10	5	11,91	11,87	x	x	x
M 12	x 1	121	38 x 10	5	11,88	11,85	x	x	x
M 12	x 1,25	12125	38 x 10	4	11,86	11,83	x	□	□
M 12	x 1,5	1215	38 x 10	4	11,85	11,81	x	x	x
M 12	x 1,5	1216	38 x 10	5	11,85	11,81			
M 13	x 1	131	38 x 10	5	12,88	12,85	x	□	□
M 14	x 1	141	38 x 10	5	13,88	13,85	x	x	x
M 14	x 1,25	14125	38 x 10	5	13,86	13,83	x	□	□
M 14	x 1,5	1415	38 x 10	5	13,85	13,81	x	x	x
M 15	x 1	151	38 x 10	5	14,88	14,85	x	□	□
M 15	x 1,5	1515	38 x 10	5	14,85	14,81	x	□	
M 16	x 1	161	45 x 14	5	15,88	15,85	x	x	x
M 16	x 1,25	16125	45 x 14	5	15,87	15,83	x		
M 16	x 1,5	1615	45 x 14	5	15,85	15,81	x	x	x

Bis einschl. Stg. 0,25 Toleranz 6h  
up to 0,25p incl. tolerance 6h

Fortsetzung Seite S13  
To be continued on page S13

x = ab Lager, Zwischenverkauf vorbehalten  
x = normally ex stock

Dreh-Ø = Empfehlung, Grenzmaße siehe Norm  
Turning-Ø = Recommendation. Limits see standard

□ = Verfügbar auf Anfrage  
□ = available on request

MF

Metrisches ISO Feingewinde DIN 13

Baumaße DIN-EN 22568

Form B, geschlossen, mit Schälanschnitt ab M 3

ISO Metric Fine Threads, DIN 13

Dimensions DIN-EN 22568

Form B, solid, spiral pointed from M 3

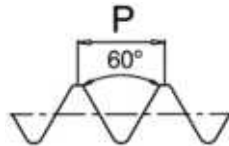
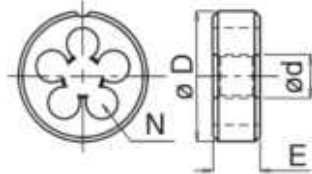

Katalog Nr. Bezeichnung	Catalogue No. Name	211 008 Hahnreiter 70	211 020 Hahnreiter MS	211 005 Nirofix				
Material	Material	HSS	HSS	HSS-EP				
Toleranz	Tolerance	6g	6g	6g				
Anschnittlänge, Gang	Chamfer length, threads	1,25	1,25	2				
Sonderwerkstoff	Special material		Messing Brass	rostfreie Stähle Stainless steels				
Zerspanungsgruppe, siehe Ausklappseite links	Machinability-group, See folder left page		3.21	1.9.4 / 1.9.5				
Oberfläche	Surface			Nit				
Ausführung	Variation	kurzer Anschnitt  short chamfer	geläppt  lapped	geläppt  lapped				
d	P	Code	D x E	N	Dreh-Ø / Turning-Ø 6g 6e		Verfügbarkeit Availability	
	mm		mm					
M 2	x 0,25	02025	16 x 5	4	1,97	1,92		
M 2,2	x 0,25	022025	16 x 5	4	2,17	2,12		
M 2,5	x 0,35	025035	16 x 5	4	2,44	2,41		
M 3	x 0,35	03035	20 x 5	4	2,94	2,91		
M 3,5	x 0,35	035035	20 x 5	4	3,44	3,41		
M 4	x 0,35	04035	20 x 5	4	3,94	3,91		
M 4	x 0,5	0405	20 x 5	4	3,92	3,89		
M 5	x 0,5	0505	20 x 5	4	4,92	4,89		
M 6	x 0,5	0605	20 x 5	4	5,92	5,89		
M 6	x 0,75	06075	20 x 7	4	5,90	5,87		
M 7	x 0,75	07075	25 x 9	4	6,90	6,87		
M 8	x 0,5	0805	25 x 9	5	7,92	7,89		
M 8	x 0,75	08075	25 x 9	4	7,90	7,87		
M 8	x 1	081	25 x 9	4	7,88	7,85		
M 9	x 0,75	09075	25 x 9	5	8,90	8,87		
M 9	x 1	091	25 x 9	5	8,88	8,85		
M 10	x 0,5	1005	30 x 11	5	9,92	9,89		
M 10	x 0,75	10075	30 x 11	5	9,90	9,87		
M 10	x 1	101	30 x 11	5	9,88	9,85		
M 10	x 1,25	10125	30 x 11	4	9,86	9,83		
M 12	x 0,5	1205	38 x 10	5	11,92	11,89		
M 12	x 0,75	12075	38 x 10	5	11,91	11,87		
M 12	x 1	121	38 x 10	5	11,88	11,85		
M 12	x 1,25	12125	38 x 10	4	11,86	11,83		
M 12	x 1,5	1215	38 x 10	4	11,85	11,81		
M 12	x 1,5	1216	38 x 10	5	11,85	11,81		
M 13	x 1	131	38 x 10	5	12,88	12,85		
M 14	x 1	141	38 x 10	5	13,88	13,85		
M 14	x 1,25	14125	38 x 10	5	13,86	13,83		
M 14	x 1,5	1415	38 x 10	5	13,85	13,81		
M 15	x 1	151	38 x 10	5	14,88	14,85		
M 15	x 1,5	1515	38 x 10	5	14,85	14,81		
M 16	x 1	161	45 x 14	5	15,88	15,85		
M 16	x 1,25	16125	45 x 14	5	15,87	15,83		
M 16	x 1,5	1615	45 x 14	5	15,85	15,81		

Fortsetzung Seite S14  
To be continued on page S14

Dreh-Ø = Empfehlung, Grenzmaße siehe Norm  
Turning-Ø = Recommendation. Limits see standard

x = ab Lager, Zwischenverkauf vorbehalten  
x = normally ex stock

☐ = Verfügbar auf Anfrage  
☐ = available on request

MF

Metrisches ISO Feingewinde DIN 13

Baumaße DIN-EN 22568

Form B, geschlossen, mit Schälanschnitt ab M 3

ISO Metric Fine Threads, DIN 13

Dimensions DIN-EN 22568

Form B, solid, spiral pointed from M 3

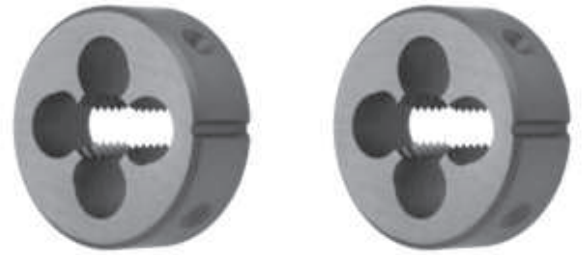
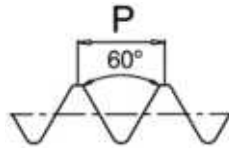
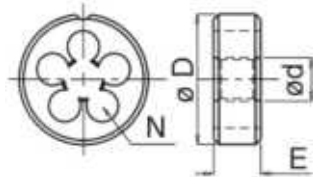

Katalog Nr.	Catalogue No.				211 000	211 001	211 002	211 010	211 011
Bezeichnung	Name				Hahnreiter	Hahnreiter GL	Hahnreiter LH	Hahnreiter 6e	Hahnreiter 6e GL
Material	Material				HSS	HSS	HSS	HSS	HSS
Toleranz	Tolerance				6g	6g	6g	6e	6e
Anschnittlänge, Gang	Chamfer length, threads				1,75	1,75	1,75	1,75	1,75
Sonderwerkstoff	Special material								
Zerspanungsgruppe, siehe Ausklappseite links	Machinability-group, See folder left page								
Oberfläche	Surface								
Ausführung	Variation					geläppt	Links	Abmaß	Abmaß geläppt
						lapped	Left hand	Undersize	Undersize lapped
d	P	Code	D x E	N	Dreh-Ø / Turning-Ø		Verfügbarkeit		
	mm		mm		6g	6e	Availability		
M 18	x 1	181	45 x 14	5	17,88	17,85	x	x	x
M 18	x 1,5	1815	45 x 14	5	17,85	17,81	x	x	x
M 18	x 2	182	45 x 14	5	17,82	17,78	x	□	□
M 20	x 1	201	45 x 14	6	19,88	19,85	x	x	x
M 20	x 1,5	2015	45 x 14	6	19,85	19,81	x	x	x
M 20	x 2	202	45 x 14	6	19,82	19,78	x	x	□
M 22	x 1	221	55 x 16	6	21,88	21,85	x	x	x
M 22	x 1,5	2215	55 x 16	5	21,85	21,81	x	x	x
M 22	x 1,5	2216	55 x 16	6	21,85	21,81	x	□	□
M 22	x 2	222	55 x 16	5	21,82	21,78	x	□	□
M 24	x 1	241	55 x 16	6	23,88	23,85	x	x	□
M 24	x 1,5	2415	55 x 16	6	23,85	23,81	x	x	x
M 24	x 2	242	55 x 16	6	23,82	23,78	x	x	□
M 25	x 1	251	55 x 16	6	24,88	24,85	x	x	□
M 25	x 1,5	2515	55 x 16	6	24,85	24,81	x	x	□
M 27	x 1	271	65 x 18	6	26,88	26,85	x	x	□
M 27	x 1,5	2715	65 x 18	6	26,85	26,81	x	x	□
M 27	x 2	272	65 x 18	6	26,82	26,78	x	x	□
M 28	x 1,5	2815	65 x 18	6	27,85	27,81	x	x	□
M 28	x 2	282	65 x 18	6	27,82	27,79	x	x	□
M 30	x 1	301	65 x 18	7	29,88	29,85	x	x	□
M 30	x 1,5	3015	65 x 18	6	29,85	29,81	x	x	□
M 30	x 2	302	65 x 18	6	29,82	29,78	x	x	□
M 32	x 1,5	3215	65 x 18	7	31,85	31,81	x	x	□
M 32	x 2	322	65 x 18	7	31,82	31,79	x	x	□
M 33	x 1,5	3315	65 x 18	7	32,87	32,81	x	x	□
M 33	x 2	332	65 x 18	7	32,82	32,79	x	x	□
M 34	x 1,5	3415	65 x 18	7	33,85	33,81	x	x	□
M 35	x 1,5	3515	65 x 18	8	34,85	34,81	x	x	□
M 36	x 1,5	3615	65 x 18	8	35,85	35,81	x	x	□
M 36	x 2	362	65 x 18	8	35,82	35,79	x	x	□
M 36	x 3	363	65 x 25	7	35,77	35,73	x	x	□
M 38	x 1,5	3815	75 x 20	7	37,85	37,81	x	x	□
M 39	x 1,5	3915	75 x 20	7	38,85	38,81	x	x	□
M 39	x 2	392	75 x 20	7	38,82	38,79	x	x	□

Fortsetzung Seite S15

To be continued on page S15

Dreh-Ø = Empfehlung, Grenzmaße siehe Norm  
Turning-Ø = Recommendation. Limits see standard

x = ab Lager, Zwischenverkauf vorbehalten

x = normally ex stock

□ = Verfügbar auf Anfrage

□ = available on request

MF

Metrisches ISO Feingewinde DIN 13

Baumaße DIN-EN 22568

Form B, geschlossen, mit Schälanschnitt ab M 3

ISO Metric Fine Threads, DIN 13

Dimensions DIN-EN 22568

Form B, solid, spiral pointed from M 3

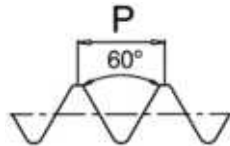
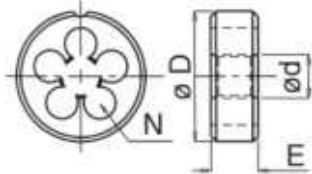

Katalog Nr. Bezeichnung	Catalogue No. Name	211 020 Hahnreiter MS	211 005 Nirofix			
Material	Material	HSS	HSS-EP			
Toleranz	Tolerance	6g	6g			
Anschnittlänge, Gang	Chamfer length, threads	1,25	2			
Sonderwerkstoff	Special material	Messing Brass	rostfreie Stähle Stainless steels			
Zerspanungsgruppe, siehe Ausklappseite links	Machinability-group, See folder left page	3.21	1.9.4 / 1.9.5			
Oberfläche	Surface		Nit			
Ausführung	Variation	geläppt  lapped	geläppt  lapped			

d	P mm	Code	D x E mm	N	Dreh-Ø / Turning-Ø 6g 6e		Verfügbarkeit Availability				
M 18	x 1	181	45 x 14	5	17,88	17,85	x	□			
M 18	x 1,5	1815	45 x 14	5	17,85	17,81	x	x			
M 18	x 2	182	45 x 14	5	17,82	17,78	□				
M 20	x 1	201	45 x 14	6	19,88	19,85	x	x			
M 20	x 1,5	2015	45 x 14	6	19,85	19,81	x	x			
M 20	x 2	202	45 x 14	6	19,82	19,78	□	□			
M 22	x 1	221	55 x 16	6	21,88	21,85	x	□			
M 22	x 1,5	2215	55 x 16	5	21,85	21,81	x				
M 22	x 1,5	2216	55 x 16	6	21,85	21,81		x			
M 22	x 2	222	55 x 16	5	21,82	21,78		□			
M 24	x 1	241	55 x 16	6	23,88	23,85	□	□			
M 24	x 1,5	2415	55 x 16	6	23,85	23,81	x	x			
M 24	x 2	242	55 x 16	6	23,82	23,78	□	□			
M 25	x 1	251	55 x 16	6	24,88	24,85	x	□			
M 25	x 1,5	2515	55 x 16	6	24,85	24,81		□			
M 27	x 1	271	65 x 18	6	26,88	26,85					
M 27	x 1,5	2715	65 x 18	6	26,85	26,81	□	□			
M 27	x 2	272	65 x 18	6	26,82	26,78		□			
M 28	x 1,5	2815	65 x 18	6	27,85	27,81	□	□			
M 28	x 2	282	65 x 18	6	27,82	27,79					
M 30	x 1	301	65 x 18	7	29,88	29,85	□	□			
M 30	x 1,5	3015	65 x 18	6	29,85	29,81	□	x			
M 30	x 2	302	65 x 18	6	29,82	29,78	□	□			
M 32	x 1,5	3215	65 x 18	7	31,85	31,81	□				
M 32	x 2	322	65 x 18	7	31,82	31,79		□			
M 33	x 1,5	3315	65 x 18	7	32,87	32,81	□	□			
M 33	x 2	332	65 x 18	7	32,82	32,79		□			
M 34	x 1,5	3415	65 x 18	7	33,85	33,81	□				
M 35	x 1,5	3515	65 x 18	8	34,85	34,81	□	□			
M 36	x 1,5	3615	65 x 18	8	35,85	35,81	□				
M 36	x 2	362	65 x 18	8	35,82	35,79	□	□			
M 36	x 3	363	65 x 25	7	35,77	35,73					
M 38	x 1,5	3815	75 x 20	7	37,85	37,81	□	□			
M 39	x 1,5	3915	75 x 20	7	38,85	38,81		□			
M 39	x 2	392	75 x 20	7	38,82	38,79					

Fortsetzung Seite S16  
To be continued on page S16

Dreh-Ø = Empfehlung, Grenzmaße siehe Norm  
Turning-Ø = Recommendation. Limits see standard

x = ab Lager, Zwischenverkauf vorbehalten  
x = normally ex stock

□ = Verfügbar auf Anfrage  
□ = available on request

MF

Metrisches ISO Feingewinde DIN 13

Baumaße DIN-EN 22568

Form B, geschlossen, mit Schälanschnitt ab M 3

ISO Metric Fine Threads, DIN 13

Dimensions DIN-EN 22568

Form B, solid, spiral pointed from M 3

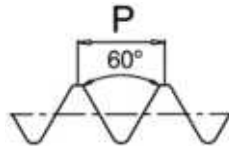
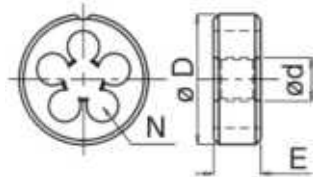

Katalog Nr. Bezeichnung	Catalogue No. Name	211 000 Hahnreiter	211 001 Hahnreiter GL	211 002 Hahnreiter LH		
Material	Material	HSS	HSS	HSS		
Toleranz	Tolerance	6g	6g	6g		
Anschnittlänge, Gang	Chamfer length, threads	1,75	1,75	1,75		
Sonderwerkstoff	Special material					
Zerspanungsgruppe, siehe Ausklappseite links	Machinability-group, See folder left page					
Oberfläche	Surface					
Ausführung	Variation		geläppt  lapped	Links  Left hand		

d	P mm	Code	D x E mm	N	Dreh-Ø / Turning-Ø 6g 6e	Verfügbarkeit Availability				
M 39	x 3	393	75 x 20	7	38,77 38,73	x	x	□		
M 40	x 1,5	4015	75 x 20	8	39,85 39,81	x	x	x		
M 40	x 2	402	75 x 20	7	39,82 39,79	x	x	□		
M 42	x 1,5	4215	75 x 20	8	41,85 41,81	x	x	x		
M 42	x 2	422	75 x 20	8	41,82 41,79	x	x	□		
M 42	x 3	423	75 x 20	8	41,77 41,73	x	x	□		
M 45	x 1,5	4515	90 x 22	7	44,85 44,81	x	x	x		
M 45	x 2	452	90 x 22	7	44,82 44,79	x	x	□		
M 45	x 3	453	90 x 22	7	44,77 44,73	x	x	□		
M 48	x 1,5	4815	90 x 22	8	47,85 47,81	x	x	x		
M 48	x 2	482	90 x 22	8	47,82 47,79	x	x	□		
M 48	x 3	483	90 x 22	7	47,77 47,73	x	x	□		
M 50	x 1,5	5015	90 x 22	8	49,85 49,81	x	x	□		
M 50	x 2	502	90 x 22	8	49,82 49,79	x	x	□		
M 52	x 1,5	5215	90 x 22	9	51,85 51,81	x	x	□		
M 52	x 2	522	90 x 22	9	51,82 51,79	x	x	□		
M 52	x 3	523	90 x 22	8	51,77 51,73	x	x	□		
M 56	x 1,5	5615	105 x 22	8	55,85 55,81	x	x	□		
M 56	x 2	562	105 x 22	8	55,82 55,79	x	x	□		
M 58	x 1,5	5815	105 x 22	8	57,85 57,81	x	x	□		
M 60	x 1,5	6015	105 x 22	9	59,85 59,81	x	x	□		
M 60	x 2	602	105 x 22	9	59,82 59,79	x	x	□		
M 60	x 3	603	105 x 22	8	59,77 59,73	□	□			
M 64	x 2	642	105 x 22	10	63,82 63,79	x	x			
M 64	x 4	644	105 x 22	9	63,70 63,66	□	□			
M 65	x 2	652	105 x 22	10	64,82 64,79	x	x			
M 70	x 2	702	120 x 22	9	69,82 69,79	x	x			
M 72	x 2	722	120 x 22	10	71,82 71,79	x	x			
M 75	x 2	752	120 x 22	10	74,82 74,79	x	x			
M 80	x 2	802	130 x 25	10	79,82 79,79	x	x	□		
M 85	x 2	852	130 x 25	12	84,82 84,79	x	x			
M 88	x 2	882	140 x 25	11	87,82 87,79	□	□			
M 90	x 2	902	140 x 25	11	89,82 89,79	□	□	□		
M 95	x 2	952	150 x 25	11	94,82 94,79	□	□			
M 100	x 2	1002	150 x 25	8	99,82 99,79	□	□			

x=ab Lager, Zwischenverkauf vorbehalten  
x= normally ex stock

□ = Verfügbar auf Anfrage  
□ = available on request

Dreh-Ø = Empfehlung, Grenzmaße siehe Norm  
Turning-Ø = Recommendation. Limits see standard



MF

Metrisches ISO Feingewinde DIN 13

Baumaße DIN-EN 22568

Form B, geschlossen, mit Schälanschnitt ab M 3

ISO Metric Fine Threads, DIN 13

Dimensions DIN-EN 22568

Form B, solid, spiral pointed from M 3

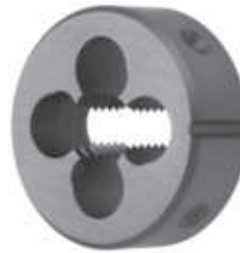
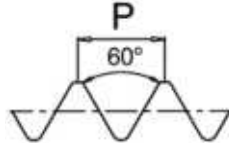
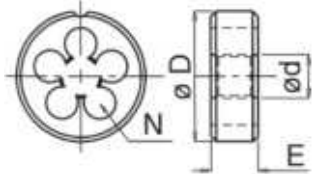

Katalog Nr. Bezeichnung	Catalogue No. Name	211 020 Hahnreiter MS	211 005 Nirofix			
Material	Material	HSS	HSS-EP			
Toleranz	Tolerance	6g	6g			
Anschnittlänge, Gang	Chamfer length, threads	1,25	2			
Sonderwerkstoff	Special material	Messing Brass	rostfreie Stähle Stainless steels			
Zerspanungsgruppe, siehe Ausklappseite links	Machinability-group, See folder left page	3.21	1.9.4 / 1.9.5			
Oberfläche	Surface		Nit			
Ausführung	Variation	geläppt	geläppt			
		<i>lapped</i>	<i>lapped</i>			

d	P mm	Code	D x E mm	N	Dreh-Ø / Turning-Ø 6g 6e	Verfügbarkeit Availability				
M 39	x 3	393	75 x 20	7	38,77 38,73					
M 40	x 1,5	4015	75 x 20	8	39,85 39,81	□				
M 40	x 2	402	75 x 20	7	39,82 39,79					
M 42	x 1,5	4215	75 x 20	8	41,85 41,81	□	□			
M 42	x 2	422	75 x 20	8	41,82 41,79					
M 42	x 3	423	75 x 20	8	41,77 41,73	□				
M 45	x 1,5	4515	90 x 22	7	44,85 44,81		□			
M 45	x 2	452	90 x 22	7	44,82 44,79					
M 45	x 3	453	90 x 22	7	44,77 44,73					
M 48	x 1,5	4815	90 x 22	8	47,85 47,81	□				
M 48	x 2	482	90 x 22	8	47,82 47,79					
M 48	x 3	483	90 x 22	7	47,77 47,73					
M 50	x 1,5	5015	90 x 22	8	49,85 49,81	□				
M 50	x 2	502	90 x 22	8	49,82 49,79					
M 52	x 1,5	5215	90 x 22	9	51,85 51,81	□	□			
M 52	x 2	522	90 x 22	9	51,82 51,79					
M 52	x 3	523	90 x 22	8	51,77 51,73					
M 56	x 1,5	5615	105 x 22	8	55,85 55,81	□				
M 56	x 2	562	105 x 22	8	55,82 55,79					
M 58	x 1,5	5815	105 x 22	8	57,85 57,81	□				
M 60	x 1,5	6015	105 x 22	9	59,85 59,81					
M 60	x 2	602	105 x 22	9	59,82 59,79					
M 60	x 3	603	105 x 22	8	59,77 59,73					
M 64	x 2	642	105 x 22	10	63,82 63,79					
M 64	x 4	644	105 x 22	9	63,70 63,66					
M 65	x 2	652	105 x 22	10	64,82 64,79	□				
M 70	x 2	702	120 x 22	9	69,82 69,79	□				
M 72	x 2	722	120 x 22	10	71,82 71,79					
M 75	x 2	752	120 x 22	10	74,82 74,79					
M 80	x 2	802	130 x 25	10	79,82 79,79	□				
M 85	x 2	852	130 x 25	12	84,82 84,79					
M 88	x 2	882	140 x 25	11	87,82 87,79	□				
M 90	x 2	902	140 x 25	11	89,82 89,79					
M 95	x 2	952	150 x 25	11	94,82 94,79					
M 100	x 2	1002	150 x 25	8	99,82 99,79					

x = ab Lager, Zwischenverkauf vorbehalten  
x = normally ex stock

□ = Verfügbar auf Anfrage  
□ = available on request

Dreh-Ø = Empfehlung, Grenzmaße siehe Norm  
Turning-Ø = Recommendation. Limits see standard

**MF**

**Metrisches ISO Feingewinde DIN 13**

Baumaße Werknorm, mit Aufschraubblöchern

Form B, geschlossen, mit Schälanschnitt ab M 3

**ISO Metric Fine Threads, DIN 13**

Dimensions manufacturer's standard, with fixing holes

Form B, solid, spiral pointed from M 3

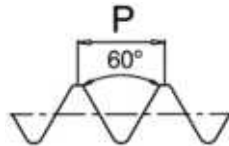
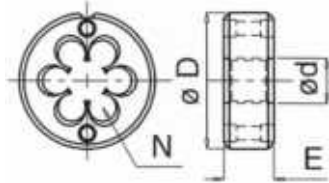

Katalog Nr. Bezeichnung	Catalogue No. Name	211 401 Hahnreiter GL	211 420 Hahnreiter MS			
Material	Material	HSS	HSS			
Toleranz	Tolerance	6g	6g			
Anschnittlänge, Gang	Chamfer length, threads	1,75	1,25			
Sonderwerkstoff	Special material		Messing Brass			
Zerspanungsgruppe, siehe Ausklappseite links	Machinability-group, See folder left page		3.21			
Oberfläche	Surface					
Ausführung	Variation	geläppt	geläppt			
		<i>lapped</i>	<i>lapped</i>			

d	P mm	Code	D x E mm	N	Dreh-Ø / Turning-Ø		Verfügbarkeit Availability				
					6g	6e					
M 2	x 0,25	02025	16 x 2	4	1,97	1,92	□	□			
M 3	x 0,35	03035	16 x 3	4	2,94	2,91	x	□			
M 4	x 0,35	04035	16 x 3,5	4	3,94	3,91	□				
M 4	x 0,5	0405	16 x 4	4	3,92	3,89	x	□			
M 5	x 0,5	0505	20 x 5	4	4,92	4,89	x	□			
M 6	x 0,5	0605	20 x 5	4	5,92	5,89	x	□			
M 6	x 0,75	06075	20 x 7	4	5,90	5,87	x	□			
M 7	x 0,5	0705	25 x 7	4	6,90	6,87					
M 7	x 0,75	07075	25 x 7	4	6,90	6,87	x				
M 8	x 0,5	0805	25 x 7	6	7,92	7,89	□	□			
M 8	x 0,75	08075	25 x 7	4	7,90	7,87	x				
M 8	x 1	081	25 x 7	4	7,88	7,85	x	□			
M 10	x 0,75	10075	30 x 7	6	9,90	9,87	x				
M 10	x 1	1011	25 x 7	6	9,88	9,85					
M 10	x 1	1012	30 x 7	6	9,88	9,85	x	□			
M 10	x 1,25	10125	25 x 9	6	9,86	9,83	x				
M 12	x 1	121	30 x 7	6	11,88	11,85	x				
M 12	x 1	122	35 x 10	6	11,88	11,85					
M 12	x 1,25	12125	30 x 11	6	11,86	11,83	x				
M 12	x 1,5	1215	30 x 11	6	11,85	11,81	x				
M 14	x 1	141	35 x 10	6	13,88	13,85					
M 14	x 1,25	14125	35 x 10	6	13,86	13,83					
M 14	x 1,5	1415	35 x 10	6	13,85	13,81	x				
M 16	x 1	161	45 x 10	6	15,88	15,85					
M 16	x 1,5	1615	45 x 14	6	15,85	15,81	x				

x=ab Lager, Zwischenverkauf vorbehalten  
x=normally ex stock

□= Verfügbar auf Anfrage  
□= available on request

Dreh-Ø = Empfehlung, Grenzmaße siehe Norm  
Turning-Ø = Recommendation. Limits see standard

UNC

Unified Grobgewinde ANSI B 1.1

Baumaße DIN-EN 22568

Form B, geschlossen, mit Schälanschnitt ab Nr. 5

Unified Coarse Threads ANSI B 1.1

Dimensions DIN-EN 22568

Form B, solid, spiral pointed from No. 5

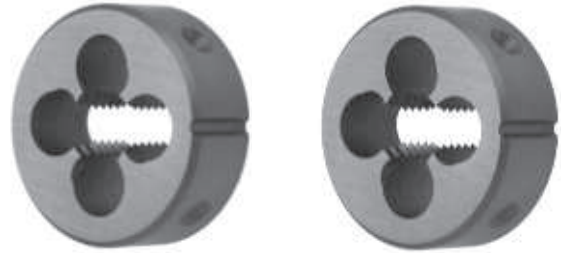
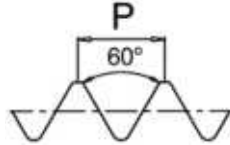
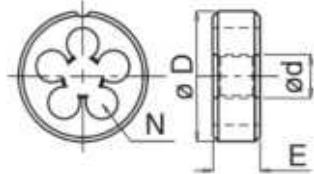

Katalog Nr. Bezeichnung	Catalogue No. Name	212 000 Hahnreiter	212 001 Hahnreiter GL	212 002 Hahnreiter LH	212 010 Hahnreiter 3A	212 005 Nirofix				
Material	Material	HSS	HSS	HSS	HSS	HSS-EP				
Toleranz	Tolerance	2A	2A	2A	3A	2A				
Anschnittlänge, Gang	Chamfer length, threads	1,75	1,75	1,75	1,75	2				
Sonderwerkstoff	Special material					rostfreie Stähle Stainless steels 1.9.4 / 1.9.5				
Zerspanungsgruppe, siehe Ausklappseite links	Machinability-group, See folder left page					Nit				
Oberfläche	Surface									
Ausführung	Variation		geläppt  lapped	Links Left hand	enge Toleranz tight tolerance	geläppt  lapped				
d	P Gg/1"	Code	D x E mm	N	Dreh-Ø / Turning-Ø 2A 3A		Verfügbarkeit Availability			
Nr. 1	- 64	01,85	16 x 5	3	1,79	1,81	x	x		
Nr. 2	- 56	02,18	16 x 5	4	2,12	2,14	x	x		
Nr. 3	- 48	02,52	16 x 5	4	2,44	2,46	x	x		
Nr. 4	- 40	02,85	16 x 5	4	2,76	2,78	x	x		
Nr. 5	- 40	03,18	20 x 5	4	3,09	3,11	x	x		
Nr. 6	- 32	03,51	20 x 7	4	3,41	3,43	x	x		
Nr. 8	- 32	04,17	20 x 7	4	4,07	4,09	x	x		
Nr. 10	- 24	04,83	20 x 7	4	4,71	4,73	x	x		
Nr. 12	- 24	05,49	20 x 7	4	5,37	5,39	x	x		
1/4	- 20	06,35	20 x 7	4	6,22	6,25	x	x		
1/4	- 20	06,35	20 x 7	5	6,22	6,25				
5/16	- 18	07,94	25 x 9	4	7,80	7,83	x	x		
5/16	- 18	07,94	25 x 9	5	7,80	7,83				
3/8	- 16	09,53	30 x 11	4	9,37	9,41	x	x		
3/8	- 16	09,53	30 x 11	5	9,37	9,41				
7/16	- 14	11,11	30 x 11	4	10,95	10,98	x	x		
7/16	- 14	11,11	30 x 11	5	10,95	10,98				
1/2	- 13	12,70	38 x 14	4	12,52	12,56	x	x		
1/2	- 13	12,70	38 x 14	5	12,52	12,56				
9/16	- 12	14,29	38 x 14	4	14,10	14,14	x	x		
9/16	- 12	14,29	38 x 14	5	14,10	14,14				
5/8	- 11	15,88	45 x 18	4	15,68	15,72	x	x		
5/8	- 11	15,88	45 x 18	5	15,68	15,72				
3/4	- 10	19,05	45 x 18	5	18,84	18,89	x	x		
7/8	- 9	22,23	55 x 22	5	22,00	22,05	x	x		
7/8	- 9	22,23	55 x 22	6	22,00	22,05				
1	- 8	25,40	55 x 22	5	25,16	25,21	x	x		
1	- 8	25,40	55 x 22	6	25,16	25,21				
1.1/8	- 7	28,58	65 x 25	5	28,31	28,37	x	x		
1.1/4	- 7	31,75	65 x 25	6	31,49	31,54	x	x		
1.3/8	- 6	34,93	65 x 25	6	34,63	34,69	x	x		
1.1/2	- 6	38,10	75 x 30	6	37,80	37,87	x	x		
1.3/4	- 5	44,45	90 x 36	6	44,12	44,19	x	x		
2	- 4,5	50,80	90 x 36	7	50,45	50,52	x	x		

x = ab Lager, Zwischenverkauf vorbehalten  
x = normally ex stock

□ = Verfügbar auf Anfrage  
□ = available on request

Dreh-Ø = Empfehlung, Grenzmaße siehe Norm  
Turning-Ø = Recommendation. Limits see standard

UNF

Unified Feingewinde ANSI B 1.1

Baumaße DIN-EN 22568

Form B, geschlossen, mit Schälanschnitt ab Nr. 5

Unified Fine Threads ANSI B 1.1

Dimensions DIN-EN 22568

Form B, solid, spiral pointed from No. 5

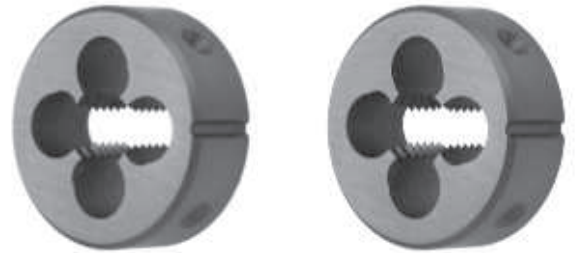
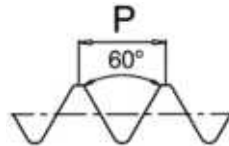
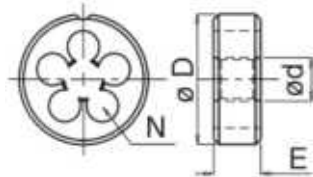

Katalog Nr. Bezeichnung	Catalogue No. Name	213 000 Hahnreiter	213 001 Hahnreiter GL	213 002 Hahnreiter LH	213 010 Hahnreiter 3A	213 005 Nirofix
Material	Material	HSS	HSS	HSS	HSS	HSS-EP
Toleranz	Tolerance	2A	2A	2A	3A	2A
Anschnittlänge, Gang	Chamfer length, threads	1,75	1,75	1,75	1,75	2
Sonderwerkstoff	Special material					rostfreie Stähle Stainless steels 1.9.4 / 1.9.5
Zerspanungsgruppe, siehe Ausklappseite links	Machinability-group, See folder left page					
Oberfläche	Surface					Nit
Ausführung	Variation		geläppt  lapped	Links Left hand	enge Toleranz tight tolerance	geläppt  lapped

d	P Gg/1"	Code	D x E mm	N	Dreh-Ø / Turning-Ø		Verfügbarkeit Availability				
					2A	3A	213 000	213 001	213 002	213 010	213 005
Nr. 0	- 80	01,52	16 x 5	3	1,47	1,49	x	x			
Nr. 1	- 72	01,85	16 x 5	3	1,79	1,81	x	x			
Nr. 2	- 64	02,18	16 x 5	4	2,12	2,14	x	x			
Nr. 3	- 56	02,52	16 x 5	4	2,44	2,46	x	x			
Nr. 4	- 48	02,85	16 x 5	4	2,77	2,79	x	x			
Nr. 5	- 44	03,18	20 x 5	4	3,10	3,12	x	x		□	□
Nr. 6	- 40	03,51	20 x 5	4	3,42	3,44	x	x		□	□
Nr. 8	- 36	04,17	20 x 7	4	4,08	4,10	x	x		□	□
Nr. 10	- 32	04,83	20 x 7	4	4,73	4,75	x	x	□	□	x
Nr. 12	- 28	05,49	20 x 7	4	5,38	5,40	x	x		□	□
1/4	- 28	06,35	20 x 7	4	6,24	6,27	x	x	x	□	x
5/16	- 24	07,94	25 x 9	4	7,82	7,85	x	x	x	□	x
3/8	- 24	09,53	30 x 11	4	9,41	9,43	x	x	x	□	
3/8	- 24	09,53	30 x 11	5	9,41	9,43					x
7/16	- 20	11,11	30 x 11	5	10,98	11,01	x	x	x	□	x
1/2	- 20	12,70	38 x 10	5	12,56	12,60	x	x	x	□	□
9/16	- 18	14,29	38 x 10	5	14,14	14,18	x	x	x	□	□
5/8	- 18	15,88	45 x 14	5	15,73	15,77	x	x	x	□	□
3/4	- 16	19,05	45 x 14	6	18,89	18,93	x	x	x	□	□
7/8	- 14	22,23	55 x 16	5	22,05	22,09	x	x	x		□
1	- 12	25,40	55 x 16	6	25,21	25,26	x	x	□		
1.1/8	- 12	28,58	65 x 18	6	28,38	28,43	x	x	□		
1.1/4	- 12	31,75	65 x 18	7	31,56	31,60	x	x	□		
1.3/8	- 12	34,93	65 x 18	8	34,73	34,78	x	x			
1.1/2	- 12	38,10	75 x 20	7	37,90	37,95	x	x	□		

x=ab Lager, Zwischenverkauf vorbehalten  
x=normally ex stock

□= Verfügbar auf Anfrage  
□= available on request

Dreh-Ø = Empfehlung, Grenzmaße siehe Norm  
Turning-Ø = Recommendation. Limits see standard

G

Whitworth Rohrgewinde DIN ISO 228

Baumaße DIN-EN 24231

Form B, geschlossen, mit Schälanschnitt

Whitworth Pipe Threads DIN ISO 228

Dimensions DIN-EN 24231

Form B, solid, spiral pointed

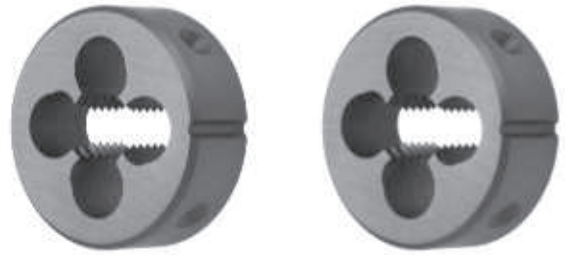
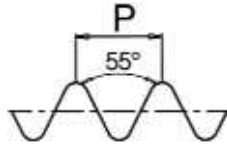
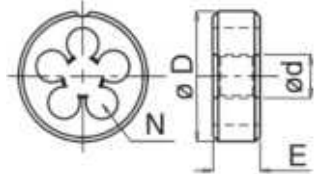

Katalog Nr. Bezeichnung	Catalogue No. Name	214 000 Hahnreiter	214 001 Hahnreiter GL	214 020 Hahnreiter MS	214 022 Hahnreiter MS -0,1	214 005 Nirofix
Material	Material	HSS	HSS	HSS	HSS	HSS-EP
Toleranz	Tolerance	A	A	A	A -0,1	A
Anschnittlänge, Gang	Chamfer length, threads	1,75	1,75	1,25	1,25	2
Sonderwerkstoff	Special material			Messing Brass	Messing Brass	rostfreie Stähle Stainless steels
Zerspanungsgruppe, siehe Ausklappseite links	Machinability-group, See folder left page			3.21	3.21	1.9.4 / 1.9.5
Oberfläche	Surface					Nit
Ausführung	Variation		geläppt <i>lapped</i>	geläppt <i>lapped</i>	Abmaß -0,1 geläppt <i>Undersize -0,1 lapped</i>	geläppt <i>lapped</i>
d	P Gg/1"	Code	D x E mm	N	Dreh-Ø / Turning-Ø A	Verfügbarkeit Availability
G 1/8	28	09,73	30 x 11	5	9,62	x x x x x
G 1/4	19	13,16	38 x 10	5	13,03	x x x x x
G 3/8	19	16,66	45 x 14	5	16,54	x x x x x
G 1/2	14	20,96	45 x 14	6	20,81	x x x x x
G 5/8	14	22,91	55 x 16	5	22,77	x x □ □
G 5/8	14	22,91	55 x 16	6	22,77	□ □ □ □
G 3/4	14	26,44	55 x 16	6	26,30	x x x x x
G 7/8	14	30,20	65 x 18	6	30,06	x x □ □ □
G 1	11	33,25	65 x 18	7	33,07	x x x x x
G 1	11	33,25	65 x 18	8	33,07	□ □ □ □ □
G 1.1/8	11	37,90	75 x 20	7	37,72	x x x x x
G 1.1/4	11	41,91	75 x 20	8	41,73	x x x x x
G 1.1/4	11	41,91	75 x 20	9	41,73	□ □ □ □ □
G 1.1/2	11	47,80	90 x 22	8	47,62	x x x x x
G 1.1/2	11	47,80	90 x 22	9	47,62	□ □ □ □ □
G 1.3/4	11	53,75	90 x 22	9	53,57	x x x x x
G 2	11	59,61	105 x 22	9	59,43	x x x x x
G 2	11	59,61	105 x 22	11	59,43	□ □ □ □ □
G 2.1/4	11	65,71	105 x 22	10	65,49	x x x x x
G 2.1/2	11	75,18	120 x 22	10	74,97	x x x x x
G 2.3/4	11	81,53	120 x 22	12	81,32	x x x x x
G 3	11	87,88	130 x 25	8	87,67	x x x x x
G 3.1/2	11	100,30	150 x 25	8	100,11	□ □ □ □ □
G 4	11	113,00	160 x 25	9	112,81	□ □ □ □ □

x = ab Lager, Zwischenverkauf vorbehalten  
x = normally ex stock

□ = Verfügbar auf Anfrage  
□ = available on request

Dreh-Ø = Empfehlung, Grenzmaße siehe Norm  
Turning-Ø = Recommendation. Limits see standard

**G**

**Whitworth Rohrgewinde DIN ISO 228**

Baumaße Werksnorm, **Glockenform**

Form B, geschlossen, mit Schälanschnitt

**Whitworth Pipe Threads DIN ISO 228**

Dimensions manufacturer's standard, bell form

Form B, solid, spiral pointed

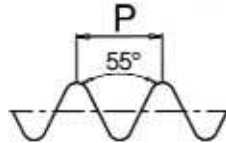
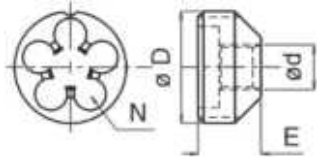

Katalog Nr. Bezeichnung	Catalogue No. Name	214 201 Hahnreiter GL	214 220 Hahnreiter MS	214 222 Hahn. MS -0,1		
Material	Material	HSS	HSS	HSS		
Toleranz	Tolerance	A	A	A -0,1		
Anschnittlänge, Gang	Chamfer length, threads	1,75	1,25	1,25		
Sonderwerkstoff	Special material		Messing Brass	Messing Brass		
Zerspanungsgruppe, siehe Ausklappseite links	Machinability-group, See folder left page		3.21	3.21		
Oberfläche	Surface					
Ausführung	Variation	geläppt	geläppt	Abmaß -0,1 geläppt		
		<i>lapped</i>	<i>lapped</i>	<i>Undersize -0,1 lapped</i>		

d	P Gg/1"	Code	D x E mm	N	Dreh-Ø / Turning-Ø A	Verfügbarkeit Availability		
G 1/8	28	09,73	25 x 14	5	9,62	<input type="checkbox"/>	<input type="checkbox"/>	<input type="checkbox"/>
G 1/4	19	13,16	30 x 18	6	13,03	<input type="checkbox"/>	<input checked="" type="checkbox"/>	<input type="checkbox"/>
G 3/8	19	16,66	38 x 20	6	16,54	<input type="checkbox"/>	<input checked="" type="checkbox"/>	<input type="checkbox"/>
G 1/2	14	20,96	45 x 24	6	20,81	<input type="checkbox"/>	<input checked="" type="checkbox"/>	<input type="checkbox"/>
G 3/4	14	26,44	55 x 28	6	26,30	<input type="checkbox"/>	<input checked="" type="checkbox"/>	<input type="checkbox"/>
G 1	11	33,25	65 x 30	7	33,07	<input type="checkbox"/>	<input checked="" type="checkbox"/>	<input type="checkbox"/>

Ab G 1/2 Schneideisen mit geschliffenem Gewinde in HSS und HM auf Anfrage, siehe Seite S29  
From G 1/2 dies with ground thread in HSS and solid carbide on request, see page S29

Technische Informationen zum Thema Rohrgewinde siehe Seite T20  
For technical information concerning pipe threads, please see page T22

x=ab Lager, Zwischenverkauf vorbehalten  
x= normally ex stock

= Verfügbar auf Anfrage  
 = available on request

Dreh-Ø = Empfehlung, Grenzmaße siehe Norm  
Turning-Ø = Recommendation. Limits see standard



R

Whitworth Rohrgewinde DIN EN 10226, ISO 7, DIN 2999 (zurückgezogen), Konus 1 : 16

Baumaße DIN-EN 24230

Form B, geschlossen, mit Schälanschnitt

Whitworth Pipe Threads DIN EN 10226, ISO 7, DIN 2999 (withdrawn), Taper 1 : 16

Dimensions DIN-EN 24230

Form B, solid, spiral pointed

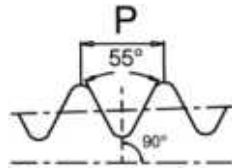
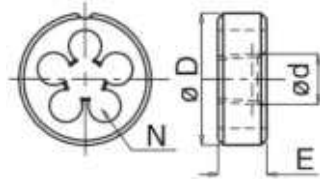

Katalog Nr. Bezeichnung	Catalogue No. Name	223 000 Hahnreiter	223 020 Hahnreiter MS	223 005 Nirofix						
Material	Material	HSS	HSS	HSS-EP						
Toleranz	Tolerance	1,75	1,25	2						
Anschnittlänge, Gang	Chamfer length, threads									
Sonderwerkstoff	Special material		Messing Brass	rostfreie Stähle Stainless steels						
Zerspanungsgruppe, siehe Ausklappseite links	Machinability-group, See folder left page		3.21	1.9.4 / 1.9.5						
Oberfläche	Surface			Nit						
Ausführung	Variation	konisch  taper	konisch geläppt  taper lapped	konisch geläppt  taper lapped						
d	P Gg/1"	Code	D x E mm	N	L (Richtwert) L (reccomend.)	Dreh-Ø / Turning-Ø D <sub>0</sub>	Verfügbarkeit Availability			
R 1/8	28	09,73	30 x 11	5	8,2	9,48	x	□	□	
R 1/4	19	13,16	38 x 14	5	12,1	12,78	x	□	□	
R 3/8	19	16,66	45 x 14	5	12,5	16,26	x	□	□	
R 1/2	14	20,96	45 x 18	6	16,4	20,44	x	□	□	
R 3/4	14	26,44	55 x 22	6	17,7	25,85	x	□		
R 1	11	33,25	65 x 25	7	20,9	32,60	x			
R 1.1/4	11	41,91	75 x 26	8	23,2	41,12	x			
R 1.1/2	11	47,80	90 x 27	8	23,2	47,01	x			
R 2	11	59,61	105 x 28	9	27,5	58,62	x			
R 2.1/2	11	75,18	120 x 36	10	30,7	74,19	□			

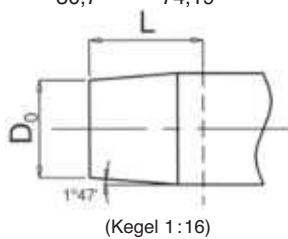

Ab R 1/2 Schneideisen mit geschliffenem Gewinde in HSS und HM auf Anfrage  
From R 1/2 dies with ground thread in HSS and solid carbide on request

Technische Informationen zum Thema Rohrgewinde siehe Seite T20  
For technical information concerning pipe threads, please see page T22

x = ab Lager, Zwischenverkauf vorbehalten  
x = normally ex stock

□ = Verfügbar auf Anfrage  
□ = available on request

Dreh-Ø = Empfehlung, Grenzmaße siehe Norm  
Turning-Ø = Recommendation. Limits see standard

**NPT**

**Amerikanisches Kegeliges Rohrgewinde - Konus 1 : 16**

nach ANSI B 1.20.1 "allg. Verwendung"

Baumaße Werknorm, Form B, geschlossen, mit Schälanschnitt

**American Taper Pipe Thread - Taper 1 : 16**

accord. to ANSI B 1.20.1 "general purpose"

Dimensions manufacturer's standard, Form B, solid, spiral pointed

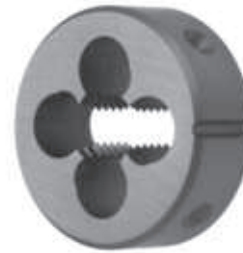
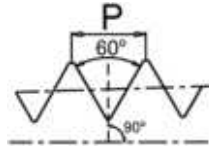
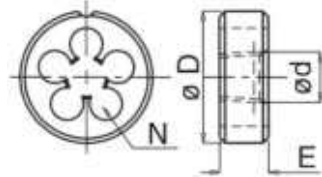

Katalog Nr. Bezeichnung	Catalogue No. Name	217 000 Hahnreiter	217 001 Hahnreiter GL	217 005 Nirofix	
Material	Material	HSS	HSS	HSS-EP	
Toleranz	Tolerance				
Anschnittlänge, Gang	Chamfer length, threads	1,75	1,75	2	
Sonderwerkstoff	Special material			rostfreie Stähle Stainless steels	
Zerspanungsgruppe, siehe Ausklappseite links	Machinability-group, See folder left page			1.9.4 / 1.9.5	
Oberfläche	Surface			Nit	
Ausführung	Variation				
		konisch  taper	konisch geläppt  taper lapped	konisch geläppt  taper lapped	

d	P Gg/1"	Code	D x E mm	N	L (Richtwert) L (reccomend.)	Dreh-Ø / Turning-Ø D <sub>0</sub>	Verfügbarkeit Availability				
1/16"	27	08,85	25 x 9	4	8,4	7,58		x	x		
1/8"	27	10,62	30 x 11	5	8,5	9,93		x	x	x	
1/4"	18	14,14	38 x 14	5	12,7	13,18		x	x	x	
3/8"	18	17,57	45 x 14	5	12,9	16,60		x	x	x	
1/2"	14	21,90	45 x 18	6	16,8	20,63		x	x	x	
3/4"	14	27,23	55 x 22	6	17,1	25,95		x	x	x	
1"	11 1/2	34,18	65 x 25	7	21,3	32,51		x	x		□
1.1/4"	11 1/2	42,90	75 x 26	8	21,9	41,23		x	x		
1.1/2"	11 1/2	48,94	90 x 27	8	22,3	47,30		x	x		
2"	11 1/2	61,00	105 x 28	9	23,1	59,31		x	x		
2.1/2"	8	71,00	120 x 36	10	34,1	71,52		□	□		
3"	8	87,00	140 x 36	11	35,7	87,30		□	□		

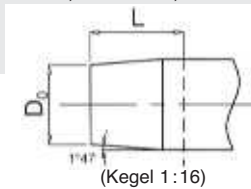

Technische Informationen zum Thema Rohrgewinde siehe Seite T21  
For technical information concerning pipe threads, please see page T23

x=ab Lager, Zwischenverkauf vorbehalten  
x= normally ex stock

□ = Verfügbar auf Anfrage  
□ = available on request

Dreh-Ø = Empfehlung, Grenzmaße siehe Norm  
Turning-Ø = Recommendation. Limits see standard

**NPTF**

**Amerikanisches Kegeliges Rohrgewinde - Konus 1 : 16**

nach ANSI B 1.20.3 "trocken dichtend"

Baumaße Werknorm, Form B, geschlossen, mit Schälanschnitt

**American Taper Pipe Thread - Taper 1 : 16**

accord. to ANSI B 1.20.3 "dry sealing"

Dimensions manufacturer's standard, Form B, solid, spiral pointed

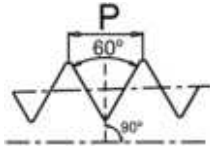
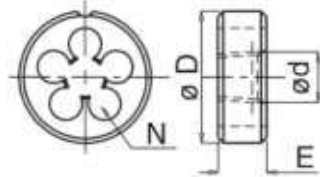

Katalog Nr. Bezeichnung	Catalogue No. Name	218 000 Hahnreiter	218 001 Hahnreiter GL	218 005 Nirofix						
Material	Material	HSS	HSS	HSS-EP						
Toleranz	Tolerance									
Anschnittlänge, Gang	Chamfer length, threads	1,75	1,75	2						
Sonderwerkstoff	Special material			rostfreie Stähle Stainless steels 1.9.4 / 1.9.5						
Zerspanungsgruppe, siehe Ausklappseite links	Machinability-group, See folder left page			Nit						
Oberfläche	Surface									
Ausführung	Variation	konisch  taper	konisch geläppt  taper lapped	konisch geläppt  taper lapped						
d	P Gg/1"	Code	D x E mm	N	L (Richtwert) L (reccomend.)	Dreh-Ø / Turning-Ø D <sub>0</sub>	Verfügbarkeit Availability			
1/16"	27	08,85	25 x 9	4	8,4	7,57	x	x		
1/8"	27	10,62	30 x 11	5	8,5	9,92	x	x	□	
1/4"	18	14,14	38 x 14	5	12,7	13,17	x	x	□	
3/8"	18	17,57	45 x 14	5	12,9	16,59	x	x	□	
1/2"	14	21,90	45 x 18	6	16,8	20,66	x	x	□	
3/4"	14	27,23	55 x 22	6	17,1	25,98	x	x	□	
1"	11 1/2	34,18	65 x 25	7	21,3	32,52	x	x	□	
1.1/4"	11 1/2	42,90	75 x 26	8	21,9	41,24	□	□		
1.1/2"	11 1/2	48,94	90 x 27	8	22,3	47,31	□	□		
2"	11 1/2	61,00	105 x 28	9	23,1	59,33	□	□		

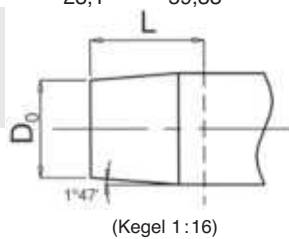

Technische Informationen zum Thema Rohrgewinde siehe Seite T21  
For technical information concerning pipe threads, please see page T23

x = ab Lager, Zwischenverkauf vorbehalten  
x = normally ex stock

□ = Verfügbar auf Anfrage  
□ = available on request

Dreh-Ø = Empfehlung, Grenzmaße siehe Norm  
Turning-Ø = Recommendation. Limits see standard

**PG**

**Stahlpanzerrohr-Gewinde, DIN 40430**

Baumaße DIN 40434

Form B, geschlossen, mit Schälanschnitt

**Steel Conduit Thread, DIN 40430**

Dimensions DIN 40434

Form B, solid, spiral pointed

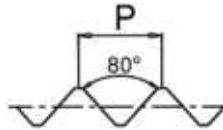
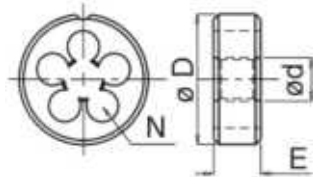

Katalog Nr. Bezeichnung	Catalogue No. Name	219 000 Hahnreiter	219 001 Hahnreiter GL	219 020 Hahnreiter MS		
Material	Material	HSS	HSS	HSS		
Toleranz	Tolerance					
Anschnittlänge, Gang	Chamfer length, threads	1,75	1,75	1,25		
Sonderwerkstoff	Special material			Messing Brass		
Zerspanungsgruppe, siehe Ausklappseite links	Machinability-group, See folder left page			3.21		
Oberfläche	Surface					
Ausführung	Variation		geläppt	geläppt		
			<i>lapped</i>	<i>lapped</i>		

d	P Gg/1"	Code	D x E mm	N	Dreh-Ø / Turning-Ø	Verfügbarkeit Availability				
Pg 7	20	12,50	38 x 10	5	12,40	x	x	□		
Pg 9	18	15,20	38 x 10	5	15,10	x	x	□		
Pg 11	18	18,60	45 x 14	5	18,50	x	x	□		
Pg 13,5	18	20,40	45 x 14	6	20,30	x	x	□		
Pg 16	18	22,50	55 x 16	5	22,40	x	x	□		
Pg 21	16	28,30	65 x 18	6	28,15	x	x	□		
Pg 29	16	37,00	65 x 18	8	36,85	x	x	□		
Pg 36	16	47,00	90 x 22	8	46,85	x	x	□		
Pg 42	16	54,00	90 x 22	10	53,85					
Pg 48	16	59,30	105 x 22	9	59,15					

x=ab Lager, Zwischenverkauf vorbehalten  
x= normally ex stock

□= Verfügbar auf Anfrage  
□= available on request

Dreh-Ø = Empfehlung, Grenzmaße siehe Norm  
Turning-Ø = Recommendation. Limits see standard

**BSW**

**Whitworth Grobgewinde, BS 84**

Baumaße DIN-EN 22568

Form B, geschlossen, mit Schälanschnitt ab 1/8

**Whitworth Coarse Threads, BS 84**

Dimensions DIN-EN 22568

Form B, solid, spiral pointed from 1/8

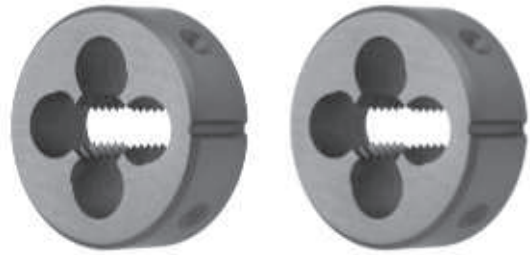
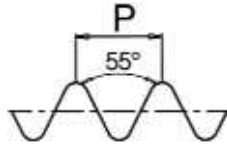
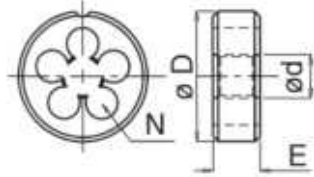

Katalog Nr. Bezeichnung	Catalogue No. Name	215 000 Hahnreiter	215 001 Hahnreiter GL	215 002 Hahnreiter LH	215 005 Nirofix	
Material	Material	HSS	HSS	HSS	HSS-EP	
Toleranz	Tolerance					
Anschnittlänge, Gang	Chamfer length, threads	1,75	1,75	1,75	2	
Sonderwerkstoff	Special material				rostfreie Stähle Stainless steels 1.9.4 / 1.9.5	
Zerspanungsgruppe, siehe Ausklappseite links	Machinability-group, See folder left page					
Oberfläche	Surface				Nit	
Ausführung	Variation		geläppt <i>lapped</i>	Links <i>Left hand</i>	geläppt <i>lapped</i>	
d	P Gg/1"	Code	D x E mm	N	Dreh-Ø / Turning-Ø	Verfügbarkeit Availability
1/16	60	01,59	16 x 5	3	1,51	<input type="checkbox"/>
3/32	48	02,38	16 x 5	4	2,30	<input type="checkbox"/>
1/8	40	03,17	20 x 5	4	3,09	<input checked="" type="checkbox"/>
5/32	32	03,97	20 x 7	4	3,88	<input checked="" type="checkbox"/>
3/16	24	04,76	20 x 7	4	4,66	<input checked="" type="checkbox"/>
7/32	24	05,56	20 x 7	4	5,46	<input checked="" type="checkbox"/>
1/4	20	06,35	20 x 7	4	6,24	<input checked="" type="checkbox"/>
1/4	20	06,35	20 x 7	5	6,24	<input type="checkbox"/>
5/16	18	07,94	25 x 9	4	7,82	<input checked="" type="checkbox"/>
5/16	18	07,94	25 x 9	5	7,82	<input type="checkbox"/>
3/8	16	09,53	30 x 11	4	9,40	<input checked="" type="checkbox"/>
3/8	16	09,53	30 x 11	5	9,40	<input type="checkbox"/>
7/16	14	11,11	30 x 11	4	10,98	<input checked="" type="checkbox"/>
1/2	12	12,70	38 x 14	4	12,56	<input checked="" type="checkbox"/>
1/2	12	12,70	38 x 14	5	12,56	<input type="checkbox"/>
9/16	12	14,29	38 x 14	4	14,14	<input checked="" type="checkbox"/>
9/16	12	14,29	38 x 14	5	14,14	<input type="checkbox"/>
5/8	11	15,88	45 x 18	4	15,72	<input checked="" type="checkbox"/>
5/8	11	15,88	45 x 18	5	15,72	<input type="checkbox"/>
3/4	10	19,05	45 x 18	5	18,89	<input checked="" type="checkbox"/>
7/8	9	22,23	55 x 22	5	22,10	<input checked="" type="checkbox"/>
7/8	9	22,23	55 x 22	6	22,10	<input type="checkbox"/>
1	8	25,40	55 x 22	5	25,27	<input checked="" type="checkbox"/>
1	8	25,40	55 x 22	6	25,27	<input type="checkbox"/>
1.1/8	7	28,58	65 x 25	5	28,44	<input checked="" type="checkbox"/>
1.1/4	7	31,75	65 x 25	6	31,61	<input checked="" type="checkbox"/>
1.3/8	6	34,93	65 x 25	6	34,77	<input checked="" type="checkbox"/>
1.1/2	6	38,10	75 x 30	6	37,95	<input checked="" type="checkbox"/>
1.5/8	5	41,28	75 x 30	7	41,11	<input type="checkbox"/>
1.3/4	5	44,45	90 x 36	6	44,28	<input checked="" type="checkbox"/>
2	4,5	50,80	90 x 36	7	50,63	<input checked="" type="checkbox"/>
2.1/4	4	57,15	105 x 36	7	56,96	<input type="checkbox"/>
2.1/2	4	63,50	105 x 36	8	63,31	<input type="checkbox"/>
2.3/4	3,5	69,85	120 x 36	8	69,65	<input type="checkbox"/>
3	3,5	76,20	120 x 36	9	76,00	<input type="checkbox"/>

x = ab Lager, Zwischenverkauf vorbehalten  
x = normally ex stock

= Verfügbar auf Anfrage  
 = available on request

Dreh-Ø = Empfehlung, Grenzmaße siehe Norm  
Turning-Ø = Recommendation. Limits see standard

Tr

Metrisches ISO Trapezgewinde, DIN 103

Baumaße » DIN-EN 22568

Form B, geschlossen, mit Schälanschnitt

Metric ISO Trapezoidal Threads DIN 103

Dimensions » DIN-EN 22568

Form B, solid, spiral pointed

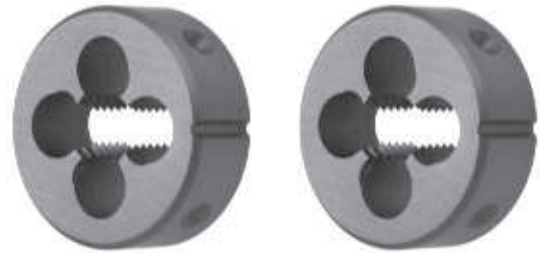
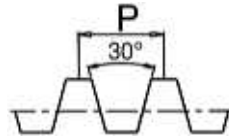
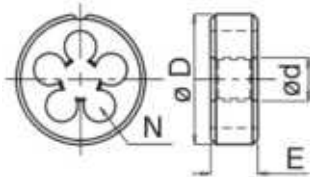

Katalog Nr.		Catalogue No.		221 000	221 002	221 020	221 022
Bezeichnung		Name		Hahnreiter	Hahnreiter LH	Hahnreiter MS	Hahn. MS -0,1
Material		Material		HSS	HSS	HSS	HSS
Toleranz		Tolerance		7e	7e	7e	7e -0,1
Anschnittlänge, Gang		Chamfer length, threads		1,75	1,75	1,25	1,25
Sonderwerkstoff		Special material				Messing Brass	Messing Brass
Zerspanungsgruppe, siehe Ausklappseite links		Machinability-group, See folder left page				3.21	3.21
Oberfläche		Surface					
Ausführung		Variation			Links  Left hand	geläppt  lapped	Abmaß -0,1 geläppt  Undersize -0,1 lapped
d	P	Code	D x E	N	Dreh-Ø / Turning-Ø	Verfügbarkeit	
	mm		mm		7e	Availability	
Tr 8	x 1,5	0815	25 x 9	4	7,93	☐	☐
Tr 9	x 1,5	0915	30 x 11	4	8,93	☐	☐
Tr 9	x 2	092	30 x 11	4	8,91	☐	☐
Tr 10	x 1,5	1015	30 x 11	4	9,93	☐	☐
Tr 10	x 2	102	38 x 14	4	9,91	x	☐
Tr 10	x 3	103	38 x 14	4	9,88	x	☐
Tr 11	x 2	112	38 x 14	4	10,91	☐	☐
Tr 11	x 3	113	38 x 14	4	10,88	☐	☐
Tr 12	x 2	122	38 x 14	4	11,91	x	☐
Tr 12	x 3	123	38 x 14	4	11,88	x	☐
Tr 14	x 2	142	38 x 14	4	13,91	x	☐
Tr 14	x 3	143	45 x 18	4	13,88	x	☐
Tr 14	x 4	144	45 x 18	4	13,85	x	☐
Tr 16	x 2	162	45 x 18	4	15,91	x	☐
Tr 16	x 4	164	45 x 18	4	15,85	x	☐
Tr 18	x 2	182	45 x 18	5	17,91	x	☐
Tr 18	x 4	184	45 x 18	5	17,85	x	☐
Tr 20	x 2	202	45 x 18	6	19,91	x	☐
Tr 20	x 4	204	55 x 22	5	19,85	x	☐
Tr 22	x 5	225	55 x 22	5	21,84	x	☐
Tr 24	x 3	243	55 x 22	5	23,88	☐	☐
Tr 24	x 5	245	65 x 25	5	23,84	x	☐
Tr 26	x 5	265	65 x 25	5	25,84	x	☐
Tr 28	x 5	285	65 x 25	5	27,84	x	☐
Tr 30	x 3	303	65 x 25	6	29,88	☐	☐
Tr 30	x 6	306	65 x 25	5	29,82	x	☐
Tr 32	x 6	326	65 x 25	6	31,82	x	☐
Tr 36	x 6	366	65 x 25	6	35,82	x	☐

x = ab Lager, Zwischenverkauf vorbehalten  
x = normally ex stock

☐ = Verfügbar auf Anfrage  
☐ = available on request

Dreh-Ø = Empfehlung, Grenzmaße siehe Norm  
Turning-Ø = Recommendation. Limits see standard



Rd

Rundgewinde DIN 405

Baumaße » DIN-EN 22568

Form B, geschlossen, mit Schälanschnitt

Round Threads DIN 405

Dimensions » DIN-EN 22568

Form B, solid, spiral pointed

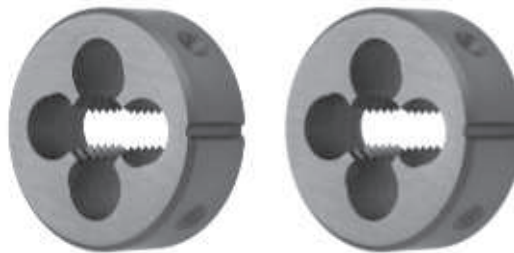
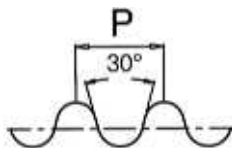
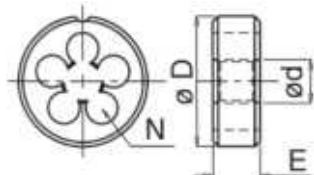

Katalog Nr. Bezeichnung	Catalogue No. Name	222 000 Hahnreiter	222 001 Hahnreiter GL	222 020 Hahnreiter MS	222 023 Hahnreiter MS LH	
Material	Material	HSS	HSS	HSS	HSS	
Toleranz	Tolerance	7h	7h	7h	7h	
Anschnittlänge, Gang	Chamfer length, threads	1,75	1,75	1,25	1,25	
Sonderwerkstoff	Special material			Messing Brass	Messing Brass	
Zerspanungsgruppe, siehe Ausklappseite links	Machinability-group, See folder left page			3.21	3.21	
Oberfläche	Surface					
Ausführung	Variation		geläppt <i>lapped</i>	geläppt <i>lapped</i>	Links geläppt <i>Left hand lapped</i>	
d	P Gg/1"	Code	D x E mm	N	Dreh-Ø / Turning-Ø 7h	Verfügbarkeit Availability
Rd 8	- 1/10	08	30 x 11	4	7,83	<input type="checkbox"/>
Rd 10	- 1/10	10	38 x 14	4	9,83	<input checked="" type="checkbox"/>
Rd 11	- 1/10	11	38 x 14	4	10,83	<input checked="" type="checkbox"/>
Rd 12	- 1/10	12	38 x 14	4	11,83	<input checked="" type="checkbox"/>
Rd 14	- 1/10	14	45 x 18	4	13,82	<input checked="" type="checkbox"/>
Rd 16	- 1/8	16	45 x 18	4	15,82	<input checked="" type="checkbox"/>
Rd 18	- 1/8	18	45 x 18	5	17,82	<input checked="" type="checkbox"/>
Rd 20	- 1/8	20	55 x 22	5	19,82	<input checked="" type="checkbox"/>
Rd 22	- 1/8	22	55 x 22	5	21,77	<input checked="" type="checkbox"/>
Rd 24	- 1/8	24	55 x 22	5	23,77	<input checked="" type="checkbox"/>
Rd 26	- 1/8	26	65 x 25	5	25,77	<input type="checkbox"/>
Rd 28	- 1/8	28	65 x 25	6	27,77	<input type="checkbox"/>
Rd 30	- 1/8	30	65 x 25	6	29,77	<input checked="" type="checkbox"/>
Rd 32	- 1/8	32	65 x 25	6	31,77	<input checked="" type="checkbox"/>
Rd 36	- 1/8	36	65 x 25	7	35,77	<input type="checkbox"/>
Rd 38	- 1/8	38	75 x 30	7	37,77	<input type="checkbox"/>
Rd 40	- 1/6	40	75 x 30	7	39,70	<input type="checkbox"/>
Rd 42	- 1/6	42	75 x 30	8	41,70	<input type="checkbox"/>
Rd 44	- 1/6	44	90 x 36	7	43,70	<input type="checkbox"/>

x= ab Lager, Zwischenverkauf vorbehalten  
x= normally ex stock

= Verfügbar auf Anfrage  
= available on request

Dreh-Ø = Empfehlung, Grenzmaße siehe Norm  
Turning-Ø = Recommendation. Limits see standar

## Sonder-Gewindeschneideisen / Hartmetall-Schneideisen Special Dies / Carbide Dies

Neben dem Standardprogramm fertigen wir für Sie alle Arten von Sonder-Gewindeschneideisen:

- Sonderbaumaße für im Katalog aufgeführte Gewindearten
- Sondergewindeprofile
- Anpassung an besondere Werkstoffe
- Automatschneideisen für Spezialmaschinen

### Hartmetall-Schneideisen mit geschliffenem und hinterschliffenem Gewinde für Rotguss und Messing

- Metrische Gewinde  $> \varnothing 16$  mm und Steigungen von 1 mm bis 2,5 mm
- Zylindrische und konische Rohrgewinde  $> \varnothing 1/2''$  und Steigungen von 14 Gang bis 11 Gang
- Aus Vollhartmetall oder mit eingelöteten Hartmetall-Schneidstegen

Zur Herstellung von Schneideisen mit Spezial-Gewindeprofilen sind ggf. Hilfswerkzeuge erforderlich. Falls nicht vorhanden, müssen wir die Kosten hierfür in Rechnung stellen.



We produce all kind of special dies in addition to our standard program.

- Special dimensions for thread forms, mentioned in the catalogue
- Special thread profiles
- Modifications to suit problematic materials
- Die for special automatic machines

### Carbide Dies with ground and relief-ground thread, for red-brass castings and brass

- Metric threads  $> \varnothing 16$  mm and pitches from 1 mm to 2,5 mm
- Cylindrical and taper pipe threads  $> \varnothing 1/2''$  and pitches from 14 TPI to 11 TPI
- Solid carbide and brazed carbide lands

For the production of dies with special thread profiles special production tools are sometimes needed. Any additional tooling charges will be quoted separately.

## Begriffe und Bezeichnungen an Schneideisen Terms on Dies

	a	Stegbreite	width of land
	c	Breite der 90° - Nut	width of V flute
	d	Gewinde Nenn-Ø	nominal-Ø of thread
	D	Außen-Ø	outside-Ø of die
	D <sub>2</sub>	Ø der Schneidglocke	bell-Ø
	d <sub>3</sub>	Vorbau-Ø	extension-Ø
	d <sub>4</sub>	Ø-Bohrung für Halteschraube	spot-hole-Ø
	d <sub>5</sub>	Halte Loch-Ø	Ø-of hole for holding screw
	d <sub>6</sub>	Abstand Halte Löcher	distance between holding screw holes
	e	Vorbauhöhe	height of extension
	E	Breite des Schneideisens	width of die
	N	Anzahl Spanlöcher	number of clearance holes
	S <sub>5</sub>	Anschnittinterschliff	radial relief of chamfer
	α <sub>p</sub>	Anschnittfreiwinkel	chamfer relief angle
χ <sub>r</sub>	Anschnittwinkel (= 1/2 Senkwinkel)	chamfer angle (= 1/2 countersink angle)	
γ <sub>fA</sub>	Schälanschnittwinkel	spiral point angle	
γ <sub>p</sub>	Spanwinkel	rake angle	
1	Spanloch	clearance hole	
2	Schälanschnitt	Spiral Point	
3	Steg	land	
4	Form A geschlitzt	form A slotted	
5	Form B geschlossen	form B closed/solid	
6	Halte Loch	holding screw holes	
7	erweitertes Spanloch	extended clearance hole	

# Gauges

		Page
<b>M</b>	<i>ISO Metric Coarse Threads, DIN 13</i>	L2 - L3
<b>MF</b>	<i>ISO Metric Fine Threads, DIN 13</i>	L4 - L7
<b>EG-M</b>	<i>ISO Metric Coarse Threads for wire inserts, DIN 8140</i>	L8
<b>BSW</b>	<i>Whitworth Coarse Threads BS 84</i>	L9
<b>UNC</b>	<i>Unified Coarse Threads ANSI B 1.1</i>	L10
<b>UNF</b>	<i>Unified Fine Threads ANSI B 1.1</i>	L11
<b>G</b>	<i>Whitworth Pipe Threads DIN ISO 228</i>	L12
<b>Rp/Rc / R</b>	<i>Whitworth Pipe Threads DIN EN 10226, ISO 7, DIN 2999 (withdrawn)</i>	L13
<b>NPT</b>	<i>American Taper Pipe Thread - Taper 1 : 16 accord. to ANSI B 1.20.1 "general purpose"</i>	L14
<b>NPTF</b>	<i>American Taper Pipe Thread - Taper 1 : 16 accord. to ANSI B 1.20.3 "dry sealing"</i>	L15
<b>Tr</b>	<i>Metric ISO Trapezoidal Threads DIN 103</i>	L16
<b>Rd</b>	<i>Round Threads DIN 405</i>	L17
<b>Pg</b>	<i>Steel Conduit Thread, DIN 40430</i>	L18
	<i>Limit Plug Gauges</i>	L19
	<i>Ring Gauges</i>	L20
	<i>Certificates (New Products)</i>	L21
	<i>Control check Certification (of used Gauges)</i>	L22 - L23
	<i>Special-Gauges</i>	L24

# Lehren

		Seite
<b>M</b>	Metrisches ISO-Regelgewinde DIN 13	L2 - L3
<b>MF</b>	Metrisches ISO Feingewinde DIN 13	L4 - L7
<b>EG-M</b>	Metrisches ISO-Regelgewinde für Draht-Gewindeeinsätze, <i>DIN 8140</i>	L8
<b>BSW</b>	Whitworth Grobgewinde, BS 84	L9
<b>UNC</b>	Unified Grobgewinde ANSI B 1.1	L10
<b>UNF</b>	Unified Feingewinde ANSI B 1.1	L11
<b>G</b>	Whitworth Rohrgewinde DIN ISO 228	L12
<b>Rp/Rc / R</b>	Whitworth Rohrgewinde DIN EN 10226, ISO 7, DIN 2999 (zurückgezogen)	L13
<b>NPT</b>	Amerikanisches Kegeliges Rohrgewinde - Konus 1 : 16 nach ANSI B 1.20.1 "allgemeine Verwendung"	L14
<b>NPTF</b>	Amerikanisches Kegeliges Rohrgewinde - Konus 1 : 16 nach ANSI B 1.20.3 "trocken dichtend"	L15
<b>Tr</b>	Metrisches ISO Trapezgewinde, DIN 103	L16
<b>Rd</b>	Rundgewinde DIN 405	L17
<b>Pg</b>	Stahlpanzerrohr-Gewinde, DIN 40430	L18
	Grenzlehrdorne	L19
	Lehrringe	L20
	Prüfprotokolle (Neuprüfung)	L21
	Überwachungsprüfung	L22 - L23
	Sonder-Lehren	L24

# HAHNREITER Gewindelehren

## Thread Gauges

### M

Metrisches ISO Regelgewinde DIN 13

Lehrenmaße DIN ISO 1502

ISO Metric Coarse Threads, DIN 13

Gauge size DIN ISO 1502

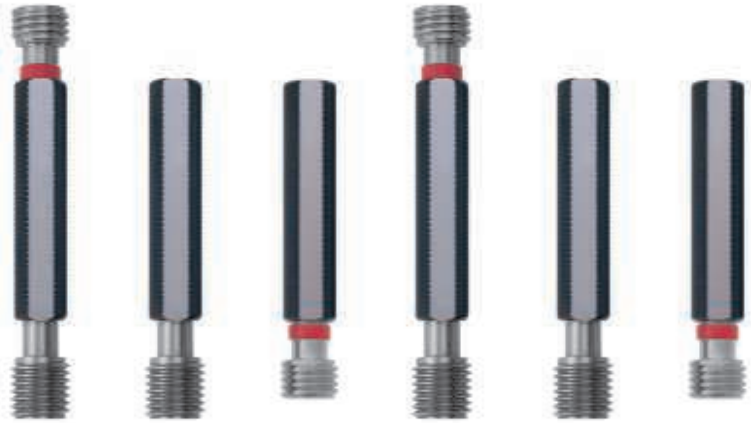
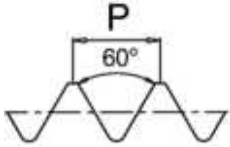

Katalog Nr. Bezeichnung	Catalogue No. Name	L10 000 Grenz- Lehrdorn Limit Plug Gauge	L10 100 Gut- Lehrdorn Plug Gauge, Go	L10 200 Ausschuss- Lehrdorn Plug Gauge, NoGo	L10 001 Grenz- Lehrdorn Limit Plug Gauge	L10 101 Gut- Lehrdorn Plug Gauge, Go	L10 201 Ausschuss- Lehrdorn Plug Gauge, NoGo	
Toleranz	Tolerance	6H	6H	6H	6G	6G	6G	
Werkstoff	Material	LS	LS	LS	LS	LS	LS	
Oberfläche	Surface							
Ausführung	Variation				Aufmaß Oversize	Aufmaß Oversize	Aufmaß Oversize	
d <sub>1</sub>	P mm	Code	Verfügbarkeit Availability					
M 1	0,25	01	x	x	x			
M 1,1	0,25	01,1	x	x	x			
M 1,2	0,25	01,2	x	x	x			
M 1,4	0,3	01,4	x	x	x			
M 1,6	0,35	01,6	x	x	x	x	x	
M 1,8	0,35	01,8	x	x	x	x	x	
M 2	0,4	02	x	x	x	x	x	
M 2,2	0,45	02,2	x	x	x	x	x	
M 2,5	0,45	02,5	x	x	x	x	x	
M 3	0,5	03	x	x	x	x	x	
M 3,5	0,6	03,5	x	x	x	x	x	
M 4	0,7	04	x	x	x	x	x	
M 4,5	0,75	04,5	x	x	x	x	x	
M 5	0,8	05	x	x	x	x	x	
M 6	1	06	x	x	x	x	x	
M 7	1	07	x	x	x	x	x	
M 8	1,25	08	x	x	x	x	x	
M 9	1,25	09	x	x	x	x	x	
M 10	1,5	10	x	x	x	x	x	
M 12	1,75	12	x	x	x	x	x	
M 14	2	14	x	x	x	x	x	
M 16	2	16	x	x	x	x	x	
M 18	2,5	18	x	x	x	x	x	
M 20	2,5	20	x	x	x	x	x	
M 22	2,5	22	x	x	x	x	x	
M 24	3	24	x	x	x	x	x	
M 27	3	27	x	x	x	x	x	
M 30	3,5	30	x	x	x	x	x	
M 33	3,5	33	x	x	x	x	x	
M 36	4	36	x	x	x	x	x	
M 39	4	39	x	x	x	x	x	
M 42	4,5	42		x	x		x	
M 45	4,5	45		x	x		x	
M 48	5	48		x	x		x	
M 52	5	52		x	x		x	

Prüfprotokolle werden extra berechnet, siehe Hinweise Seite L21  
Certificates will be charged separately, please see remarks page L21

x = ab Lager, Zwischenverkauf vorbehalten  
x = normally ex stock  
LS = Lehrenstahl / Toolsteel

Bis einschl. M 1,4 Toleranz Dorne 5H, Ringe 6h  
Up to M 1,4 incl. tolerance plugs 5H, rings 6h

# HAHNREITER Gewindelehren

## Thread Gauges

### M

**Metrisches ISO Regelgewinde DIN 13**

Lehrenmaße DIN ISO 1502

**ISO Metric Coarse Threads, DIN 13**

Gauge size DIN ISO 1502

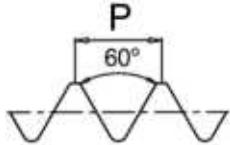

Katalog Nr. Bezeichnung	Catalogue No. Name	L10 005 Grenz- Lehrdorn Limit Plug Gauge	L10 006 Grenz- Lehrdorn Limit Plug Gauge	L10 400 Gut- Lehrring Ring Gauge Go	L10 500 Ausschuss- Lehrring Ring Gauge NoGo	L10 401 Gut- Lehrring Ring Gauge Go	L10 501 Ausschuss- Lehrring Ring Gauge NoGo	
Toleranz	Tolerance	6H	6G	6g	6g	6e	6e	
Werkstoff	Material	LS	LS	LS	LS	LS	LS	
Oberfläche	Surface	CrB2*	CrB2*					
Ausführung	Variation		Aufmaß Oversize			Abmaß Undersize	Abmaß Undersize	
d <sub>1</sub>	P mm	Code	Verfügbarkeit Availability					
M 1	0,25	01			x	x		
M 1,1	0,25	01,1			x	x		
M 1,2	0,25	01,2			x	x		
M 1,4	0,3	01,4			x	x		
M 1,6	0,35	01,6			x	x		
M 1,8	0,35	01,8			x	x	x	
M 2	0,4	02			x	x	x	
M 2,2	0,45	02,2			x	x	x	
M 2,5	0,45	02,5	x	x	x	x	x	
M 3	0,5	03	x	x	x	x	x	
M 3,5	0,6	03,5			x	x	x	
M 4	0,7	04	x	x	x	x	x	
M 4,5	0,75	04,5			x	x	x	
M 5	0,8	05	x	x	x	x	x	
M 6	1	06	x	x	x	x	x	
M 7	1	07	x	x	x	x	x	
M 8	1,25	08	x	x	x	x	x	
M 9	1,25	09			x	x	x	
M 10	1,5	10	x	x	x	x	x	
M 12	1,75	12	x	x	x	x	x	
M 14	2	14	x		x	x	x	
M 16	2	16	x	x	x	x	x	
M 18	2,5	18			x	x	x	
M 20	2,5	20	x		x	x	x	
M 22	2,5	22			x	x	x	
M 24	3	24			x	x	x	
M 27	3	27			x	x	x	
M 30	3,5	30			x	x	x	
M 33	3,5	33			x	x	x	
M 36	4	36			x	x	x	
M 39	4	39			x	x	x	
M 42	4,5	42			x	x	x	
M 45	4,5	45			x	x	x	
M 48	5	48			x	x	x	
M 52	5	52			x	x	x	

Prüfprotokolle werden extra berechnet, siehe Hinweise Seite L21  
 Certificates will be charged separately, please see remarks page L21

x = ab Lager, Zwischenverkauf vorbehalten  
 x = normally ex stock

Bis einschl. M 1,4 Toleranz Dorne 5H, Ringe 6h  
 Up to M 1,4 incl. tolerance plugs 5H, rings 6h

LS = Lehrenstahl / Toolsteel

\*solange Lagervorrat liefern wir TiCN Ausführung  
 \*as long as available we will send TiCN version



# HAHNREITER Gewindelehren

## Thread Gauges

### MF

Metrisches ISO Feingewinde DIN 13

Lehrenmaße DIN ISO 1502

ISO Metric Fine Threads, DIN 13

Gauge size DIN ISO 1502

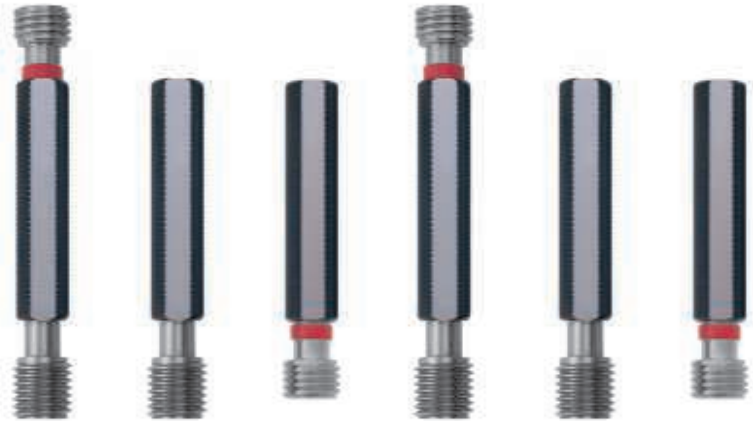
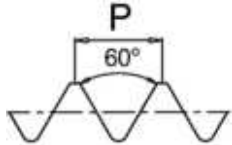

Katalog Nr. Bezeichnung	Catalogue No. Name	L11 000 Grenz- Lehrdorn Limit Plug Gauge	L11 100 Gut- Lehrdorn Plug Gauge, Go	L11 200 Ausschuss- Lehrdorn Plug Gauge, NoGo	L11 001 Grenz- Lehrdorn Limit Plug Gauge	L11 101 Gut- Lehrdorn Plug Gauge, Go	L11 201 Ausschuss- Lehrdorn Plug Gauge, NoGo
Toleranz	Tolerance	6H	6H	6H	6G	6G	6G
Werkstoff	Material	LS	LS	LS	LS	LS	LS
Oberfläche	Surface						
Ausführung	Variation				Aufmaß Oversize	Aufmaß Oversize	Aufmaß Oversize
Baumaße	Dimensions	DIN 2280	DIN 2281	DIN 2283	DIN 2280	DIN 2281	DIN 2283
d <sub>1</sub>	P mm Code	Verfügbarkeit Availability					
M 3	x 0,35 03035	x	x	x	x	x	x
M 4	x 0,5 0405	x	x	x	x	x	x
M 5	x 0,5 0505	x	x	x	x	x	x
M 6	x 0,5 0605	x	x	x	x	x	x
M 6	x 0,75 06075	x	x	x	x	x	x
M 7	x 0,75 07075	x	x	x	x	x	x
M 8	x 0,5 0805	x	x	x	x	x	x
M 8	x 0,75 08075	x	x	x	x	x	x
M 8	x 1 081	x	x	x	x	x	x
M 9	x 0,75 09075	x	x	x	x	x	x
M 9	x 1 091	x	x	x	x	x	x
M 10	x 0,5 1005	x	x	x	x	x	x
M 10	x 0,75 10075	x	x	x	x	x	x
M 10	x 1 101	x	x	x	x	x	x
M 10	x 1,25 10125	x	x	x	x	x	x
M 11	x 1 111	x	x	x	x	x	x
M 12	x 0,5 1205	x	x	x	x	x	x
M 12	x 0,75 12075	x	x	x	x	x	x
M 12	x 1 121	x	x	x	x	x	x
M 12	x 1,25 12125	x	x	x	x	x	x
M 12	x 1,5 1215	x	x	x	x	x	x
M 13	x 1 131	x	x	x	x	x	x
M 14	x 1 141	x	x	x	x	x	x
M 14	x 1,25 14125	x	x	x	x	x	x
M 14	x 1,5 1415	x	x	x	x	x	x
M 15	x 1 151	x	x	x	x	x	x
M 15	x 1,5 1515	x	x	x	x	x	x
M 16	x 1 161	x	x	x	x	x	x
M 16	x 1,5 1615	x	x	x	x	x	x
M 18	x 1 181	x	x	x	x	x	x
M 18	x 1,5 1815	x	x	x	x	x	x
M 20	x 1 201	x	x	x	x	x	x
M 20	x 1,5 2015	x	x	x	x	x	x
M 20	x 2 202	x	x	x	x	x	x
M 22	x 1 221	x	x	x	x	x	x
M 22	x 1,5 2215	x	x	x	x	x	x
M 22	x 2 222	x	x	x	x	x	x
M 24	x 1 241	x	x	x	x	x	x
M 24	x 1,5 2415	x	x	x	x	x	x
M 24	x 2 242	x	x	x	x	x	x

Prüfprotokolle werden extra berechnet, siehe Hinweise Seite L21  
Certificates will be charged separately, please see remarks page L21

Fortsetzung Seite L6  
Continued on page L6

x = ab Lager, Zwischenverkauf vorbehalten  
x = normally ex stock  
LS = Lehrenstahl / Toolsteel

# HAHNREITER Gewindelehren

## Thread Gauges

### MF

Metrisches ISO Feingewinde DIN 13

Lehrenmaße DIN ISO 1502

ISO Metric Fine Threads, DIN 13

Gauge size DIN ISO 1502

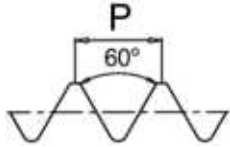

Katalog Nr. Bezeichnung	Catalogue No. Name	L11 005 Grenz- Lehrdorn Limit Plug Gauge	L11 400 Gut- Lehrring Ring Gauge Go	L11 500 Ausschuss- Lehrring Ring Gauge NoGo	L11 401 Gut- Lehrring Ring Gauge Go	L11 501 Ausschuss- Lehrring Ring Gauge NoGo
Toleranz	Tolerance	6H	6g	6g	6e	6e
Werkstoff	Material	LS	LS	LS	LS	LS
Oberfläche	Surface	CrB2*				
Ausführung	Variation				Abmaß Undersize	Abmaß Undersize
Baumaße	Dimension	DIN 2280	DIN 2281	DIN 2283	DIN 2280	DIN 2281
d <sub>1</sub>	P mm	Code	Verfügbarkeit Availability			
M 3	x 0,35	03035		x	x	x
M 4	x 0,5	0405	x	x	x	x
M 5	x 0,5	0505	x	x	x	x
M 6	x 0,5	0605		x	x	x
M 6	x 0,75	06075	x	x	x	x
M 7	x 0,75	07075		x	x	x
M 8	x 0,5	0805		x	x	x
M 8	x 0,75	08075	x	x	x	x
M 8	x 1	081	x	x	x	x
M 9	x 0,75	09075		x	x	x
M 9	x 1	091		x	x	x
M 10	x 0,5	1005		x	x	x
M 10	x 0,75	10075	x	x	x	x
M 10	x 1	101	x	x	x	x
M 10	x 1,25	10125		x	x	x
M 11	x 1	111		x	x	x
M 12	x 0,5	1205		x	x	x
M 12	x 0,75	12075	x	x	x	x
M 12	x 1	121	x	x	x	x
M 12	x 1,25	12125		x	x	x
M 12	x 1,5	1215	x	x	x	x
M 13	x 1	131		x	x	x
M 14	x 1	141	x	x	x	x
M 14	x 1,25	14125		x	x	x
M 14	x 1,5	1415	x	x	x	x
M 15	x 1	151		x	x	x
M 15	x 1,5	1515		x	x	x
M 16	x 1	161	x	x	x	x
M 16	x 1,5	1615	x	x	x	x
M 18	x 1	181	x	x	x	x
M 18	x 1,5	1815	x	x	x	x
M 20	x 1	201	x	x	x	x
M 20	x 1,5	2015	x	x	x	x
M 20	x 2	202		x	x	x
M 22	x 1	221		x	x	x
M 22	x 1,5	2215	x	x	x	x
M 22	x 2	222		x	x	x
M 24	x 1	241		x	x	x
M 24	x 1,5	2415	x	x	x	x
M 24	x 2	242		x	x	x

Prüfprotokolle werden extra berechnet, siehe Hinweise Seite L21  
Certificates will be charged separately, please see remarks page L21

Fortsetzung Seite L7  
Continued on page L7

x = ab Lager, Zwischenverkauf vorbehalten  
x = normally ex stock  
LS = Lehrenstahl / Toolsteel

\*solange Lagervorrat liefern wir noch TiCN Ausführung  
\*as long as available we will send TiCN version

# HAHNREITER Gewindelehren

## Thread Gauges

### MF

Metrisches ISO Feingewinde DIN 13

Lehrenmaße DIN ISO 1502

ISO Metric Fine Threads, DIN 13

Gauge size DIN ISO 1502

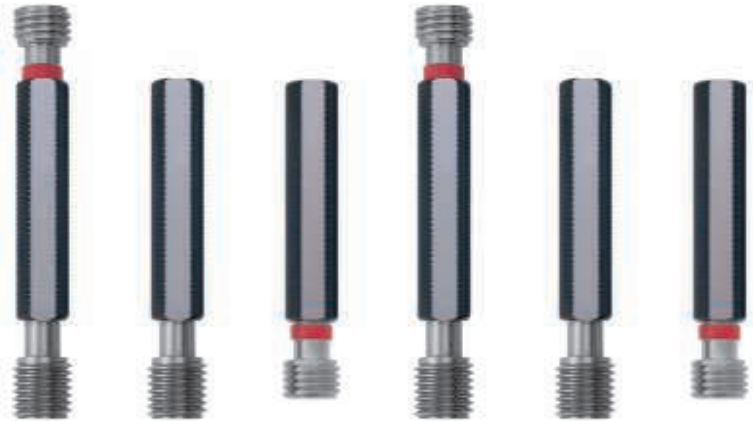
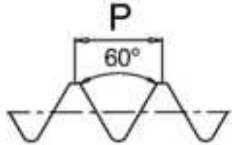

Katalog Nr. Bezeichnung	Catalogue No. Name	L11 000 Grenz- Lehrdorn Limit Plug Gauge	L11 100 Gut- Lehrdorn Plug Gauge, Go	L11 200 Ausschuss- Lehrdorn Plug Gauge, NoGo	L11 001 Grenz- Lehrdorn Limit Plug Gauge	L11 101 Gut- Lehrdorn Plug Gauge, Go	L11 201 Ausschuss- Lehrdorn Plug Gauge, NoGo
Toleranz	Tolerance	6H	6H	6H	6G	6G	6G
Werkstoff	Material	LS	LS	LS	LS	LS	LS
Oberfläche	Surface						
Ausführung	Variation				Aufmaß Oversize	Aufmaß Oversize	Aufmaß Oversize
Baumaße	Dimensions	DIN 2280	DIN 2281	DIN 2283	DIN 2280	DIN 2281	DIN 2283
d <sub>1</sub>	P mm Code	Verfügbarkeit Availability					
M 25	x 1 251	x	x	x	x	x	x
M 25	x 1,5 2515	x	x	x	x	x	x
M 26	x 1,5 2615	x	x	x	x	x	x
M 27	x 1,5 2715	x	x	x	x	x	x
M 27	x 2 272	x	x	x	x	x	x
M 28	x 1,5 2815	x	x	x	x	x	x
M 28	x 2 282	x	x	x	x	x	x
M 30	x 1 301	x	x	x	x	x	x
M 30	x 1,5 3015	x	x	x	x	x	x
M 30	x 2 302	x	x	x	x	x	x
M 32	x 1,5 3215	x	x	x	x	x	x
M 33	x 1,5 3315	x	x	x	x	x	x
M 33	x 2 332	x	x	x	x	x	x
M 34	x 1,5 3415	x	x	x	x	x	x
M 35	x 1,5 3515	x	x	x	x	x	x
M 36	x 1,5 3615	x	x	x	x	x	x
M 36	x 2 362	x	x	x	x	x	x
M 36	x 3 363	x	x	x	x	x	x
M 38	x 1,5 3815	x	x	x	x	x	x
M 39	x 1,5 3915	x	x	x	x	x	x
M 39	x 2 392	x	x	x	x	x	x
M 39	x 3 393	x	x	x	x	x	x
M 40	x 1,5 4015	x	x	x	x	x	x
M 40	x 2 402	x	x	x	x	x	x
M 40	x 3 403	x	x	x	x	x	x
M 42	x 1,5 4215		x	x		x	x
M 42	x 2 422		x	x		x	x
M 42	x 3 423		x	x		x	x
M 45	x 1,5 4515		x	x		x	x
M 45	x 2 452		x	x		x	x
M 45	x 3 453		x	x		x	x
M 48	x 1,5 4815		x	x		x	x
M 48	x 2 482		x	x		x	x
M 48	x 3 483		x	x		x	x
M 50	x 1,5 5015		x	x		x	x
M 50	x 2 502		x	x		x	x
M 50	x 3 503		x	x		x	x
M 52	x 1,5 5215		x	x		x	x
M 52	x 2 522		x	x		x	x
M 52	x 3 523		x	x		x	x

Prüfprotokolle werden extra berechnet, siehe Hinweise Seite L21  
 Certificates will be charged separately, please see remarks page L21

x = ab Lager, Zwischenverkauf vorbehalten  
 x = normally ex stock  
 LS = Lehrenstahl / Toolsteel

# HAHNREITER Gewindelehren

## Thread Gauges

### MF

Metrisches ISO Feingewinde DIN 13

Lehrenmaße DIN ISO 1502

ISO Metric Fine Threads, DIN 13

Gauge size DIN ISO 1502

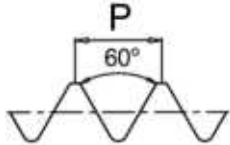

Katalog Nr. Bezeichnung	Catalogue No. Name			L11 400 Gut- Lehrring Ring Gauge Go	L11 500 Ausschuss- Lehrring Ring Gauge NoGo	L11 401 Gut- Lehrring Ring Gauge Go	L11 501 Ausschuss- Lehrring Ring Gauge NoGo
Toleranz	Tolerance			6g	6g	6e	6e
Werkstoff	Material			LS	LS	LS	LS
Oberfläche	Surface						
Ausführung	Variation					Abmaß Undersize	Abmaß Undersize
Baumaße	Dimensions			DIN 2285	DIN 2299	DIN 2285	DIN 2299
d <sub>1</sub>	P mm	Code		Verfügbarkeit Availability			
M 25	x 1	251		x	x	x	x
M 25	x 1,5	2515		x	x	x	x
M 26	x 1,5	2615		x	x	x	x
M 27	x 1,5	2715		x	x	x	x
M 27	x 2	272		x	x	x	x
M 28	x 1,5	2815		x	x	x	x
M 28	x 2	282		x	x	x	x
M 30	x 1	301		x	x	x	x
M 30	x 1,5	3015		x	x	x	x
M 30	x 2	302		x	x	x	x
M 32	x 1,5	3215		x	x	x	x
M 33	x 1,5	3315		x	x	x	x
M 33	x 2	332		x	x	x	x
M 34	x 1,5	3415		x	x	x	x
M 35	x 1,5	3515		x	x	x	x
M 36	x 1,5	3615		x	x	x	x
M 36	x 2	362		x	x	x	x
M 36	x 3	363		x	x	x	x
M 38	x 1,5	3815		x	x	x	x
M 39	x 1,5	3915		x	x	x	x
M 39	x 2	392		x	x	x	x
M 39	x 3	393		x	x	x	x
M 40	x 1,5	4015		x	x	x	x
M 40	x 2	402		x	x	x	x
M 40	x 3	403		x	x	x	x
M 42	x 1,5	4215		x	x	x	x
M 42	x 2	422		x	x	x	x
M 42	x 3	423		x	x	x	x
M 45	x 1,5	4515		x	x	x	x
M 45	x 2	452		x	x	x	x
M 45	x 3	453		x	x	x	x
M 48	x 1,5	4815		x	x	x	x
M 48	x 2	482		x	x	x	x
M 48	x 3	483		x	x	x	x
M 50	x 1,5	5015		x	x	x	x
M 50	x 2	502		x	x	x	x
M 50	x 3	503		x	x	x	x
M 52	x 1,5	5215		x	x	x	x
M 52	x 2	522		x	x	x	x
M 52	x 3	523		x	x	x	x

Prüfprotokolle werden extra berechnet, siehe Hinweise Seite L21  
Certificates will be charged separately, please see remarks page L21

x = ab Lager, Zwischenverkauf vorbehalten  
x = normally ex stock  
LS = Lehrenstahl / Toolsteel

# HAHNREITER Gewindelehren

## Thread Gauges

### EG-M

Metrisches ISO Regelgewinde für Draht-Gewindeeinsätze DIN 8140

Lehrenmaße DIN 8140, Teil 3

**ISO Metric Coarse Threads for wire inserts DIN 8140**

Gauge size DIN 8140, part 3

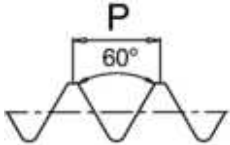

Katalog Nr. Bezeichnung	Catalogue No. Name				L33 000 Grenz- Lehrdorn Limit Plug Gauge 6H mod LS		
Toleranz	Tolerance						
Werkstoff	Material						
Oberfläche	Surface						
Ausführung	Variation						
d <sub>1</sub>	P mm	Code	Verfügbarkeit Availability				
EG M 2,5	0,45	02,5				x	
EG M 3	0,5	03				x	
EG M 3,5	0,6	03,5					
EG M 4	0,7	04				x	
EG M 5	0,8	05				x	
EG M 6	1	06				x	
EG M 8	1,25	08				x	
EG M 10	1,5	10				x	
EG M 12	1,75	12				x	
EG M 14	2	14				x	
EG M 16	2	16				x	
EG M 18	2,5	18				x	
EG M 20	2,5	20				x	
EG M 22	2,5	22					
EG M 24	3	24				x	
<p>Auch in anderen Gewindearten verfügbar. Bitte anfragen. Other thread forms also available. Please enquire.</p>							

Prüfprotokolle werden extra berechnet, siehe Hinweise Seite L21  
Certificates will be charged separately, please see remarks page L21

x = ab Lager, Zwischenverkauf vorbehalten  
x = normally ex stock

LS = Lehenstahl / Toolsteel

# HAHNREITER Gewindelehren

## Thread Gauges

### BSW

Whitworth Grobgewinde, BS 84

Lehrenmaße BS 919

**Whitworth Coarse Threads BS 84**

Gauge size BS 919

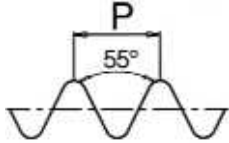

Katalog Nr. Bezeichnung	Catalogue No. Name	L15 000 Grenz- Lehrdorn <i>Limit Plug Gauge</i>	L15 100 Gut- Lehrdorn <i>Plug Gauge Go</i>	L15 200 Ausschuss- Lehrdorn <i>Plug Gauge NoGo</i>		L15 400 Gut- Lehrring <i>Ring Gauge Go</i>	L15 500 Ausschuss- Lehrring <i>Ring Gauge NoGo</i>
Toleranz	<i>Tolerance</i>	medium class	medium class	medium class		medium class	medium class
Werkstoff	<i>Material</i>	LS	LS	LS		LS	LS
Oberfläche	<i>Surface</i>						
Ausführung	<i>Variation</i>						
$d_1$	P Gg/1" $\emptyset$ mm	Verfügbarkeit <i>Availability</i>					
1/8	- 40    03,17	x	x	x		x	x
3/16	- 24    04,76	x	x	x		x	x
1/4	- 20    06,35	x	x	x		x	x
5/16	- 18    07,94	x	x	x		x	x
3/8	- 16    09,53	x	x	x		x	x
7/16	- 14    11,11	x	x	x		x	x
1/2	- 12    12,70	x	x	x		x	x
5/8	- 11    15,88	x	x	x		x	x
3/4	- 10    19,05	x	x	x		x	x
7/8	- 9    22,23	x	x	x		x	x
1	- 8    25,40	x	x	x		x	x
1.1/8	- 7    28,58	x	x	x		x	x
1.1/4	- 7    31,75	x	x	x		x	x
1.1/2	- 6    38,10	x	x	x		x	x
1.3/4	- 5    44,45		x	x		x	x
2	- 4,5    50,80		x	x		x	x

Prüfprotokolle werden extra berechnet, siehe Hinweise Seite L21  
*Certificates will be charged separately, please see remarks page L21*

**x = ab Lager, Zwischenverkauf vorbehalten**  
*x = normally ex stock*

LS = Lehenstahl / *Toolsteel*



# HAHNREITER Gewindelehren

## Thread Gauges

### UNC

Unified Grobgewinde ANSI B 1.1 - 1982

Lehrenmaße Dorne ANSI B 1.2, Ringe BS 919

Unified Coarse Threads ANSI B 1.1 - 1982

Gauge sizes plugs ANSI B 1.2, rings BS 919

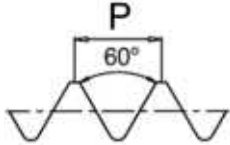

Katalog Nr. Bezeichnung	Catalogue No. Name	L12 000 Grenz- Lehrdorn Limit Plug Gauge	L12 100 Gut- Lehrdorn Plug Gauge Go	L12 200 Ausschuss- Lehrdorn Plug Gauge NoGo	L12 400 Gut- Lehrring Ring Gauge Go	L12 500 Ausschuss- Lehrring Ring Gauge NoGo
Toleranz	Tolerance	2B	2B	2B	2A	2A
Werkstoff	Material	LS	LS	LS	LS	LS
Oberfläche	Surface					
Ausführung	Variation					
d <sub>1</sub>	P Gg/1"	Ø mm	Verfügbarkeit Availability			
Nr. 1	- 64	01,85	x	x	x	x
Nr. 2	- 56	02,18	x	x	x	x
Nr. 3	- 48	02,52	x	x	x	x
Nr. 4	- 40	02,85	x	x	x	x
Nr. 5	- 40	03,18	x	x	x	x
Nr. 6	- 32	03,51	x	x	x	x
Nr. 8	- 32	04,17	x	x	x	x
Nr. 10	- 24	04,83	x	x	x	x
Nr. 12	- 24	05,49	x	x	x	x
1/4	- 20	06,35	x	x	x	x
5/16	- 18	07,94	x	x	x	x
3/8	- 16	09,53	x	x	x	x
7/16	- 14	11,11	x	x	x	x
1/2	- 13	12,70	x	x	x	x
9/16	- 12	14,29	x	x	x	x
5/8	- 11	15,88	x	x	x	x
3/4	- 10	19,05	x	x	x	x
7/8	- 9	22,23	x	x	x	x
1	- 8	25,40	x	x	x	x
1.1/8	- 7	28,58	x	x	x	x
1.1/4	- 7	31,75	x	x	x	x
1.3/8	- 6	34,93	x	x	x	x
1.1/2	- 6	38,10	x	x	x	x
1.3/4	- 5	44,45	x	x	x	x
2	- 4,5	50,80	x	x	x	x
Auch in Toleranzklasse 3B/3A verfügbar. Bitte anfragen. Also available in tolerance class 3B/3A. Please enquire.						

Prüfprotokolle werden extra berechnet, siehe Hinweise Seite L21  
 Certificates will be charged separately, please see remarks page L21

x = ab Lager, Zwischenverkauf vorbehalten  
 x = normally ex stock

LS = Lehenstahl / Toolsteel

# HAHNREITER Gewindelehren

## Thread Gauges

### UNF

Unified Feingewinde ANSI B 1.1 - 1982

Lehrenmaße Dorne ANSI B 1.2, Ringe BS 919

Unified Fine Threads ANSI B 1.1 - 1982

Gauge sizes plugs ANSI B 1.2, rings BS 919

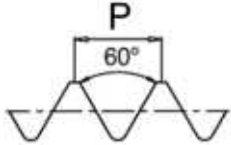

Katalog Nr. Bezeichnung	Catalogue No. Name	L13 000 Grenz- Lehrdorn <i>Limit Plug Gauge</i>	L13 100 Gut- Lehrdorn <i>Plug Gauge Go</i>	L13 200 Ausschuss- Lehrdorn <i>Plug Gauge NoGo</i>	L13 400 Gut- Lehrring <i>Ring Gauge Go</i>	L13 500 Ausschuss- Lehrring <i>Ring Gauge NoGo</i>
Toleranz	Tolerance	2B	2B	2B	2A	2A
Werkstoff	Material	LS	LS	LS	LS	LS
Oberfläche	Surface					
Ausführung	Variation					
d <sub>1</sub>	P Gg/1" Ø mm	Verfügbarkeit Availability				
Nr. 1	- 72 01,85	x	x	x	x	x
Nr. 2	- 64 02,18	x	x	x	x	x
Nr. 3	- 56 02,52	x	x	x	x	x
Nr. 4	- 48 02,85	x	x	x	x	x
Nr. 5	- 44 03,18	x	x	x	x	x
Nr. 6	- 40 03,51	x	x	x	x	x
Nr. 8	- 36 04,17	x	x	x	x	x
Nr. 10	- 32 04,83	x	x	x	x	x
Nr. 12	- 28 05,49	x	x	x	x	x
1/4	- 28 06,35	x	x	x	x	x
5/16	- 24 07,94	x	x	x	x	x
3/8	- 24 09,53	x	x	x	x	x
7/16	- 20 11,11	x	x	x	x	x
1/2	- 20 12,70	x	x	x	x	x
9/16	- 18 14,29	x	x	x	x	x
5/8	- 18 15,88	x	x	x	x	x
3/4	- 16 19,05	x	x	x	x	x
7/8	- 14 22,23	x	x	x	x	x
1	- 12 25,40	x	x	x	x	x
1.1/8	- 12 28,58	x	x	x	x	x
1.1/4	- 12 31,75	x	x	x	x	x
1.3/8	- 12 34,93	x	x	x	x	x
1.1/2	- 12 38,10	x	x	x	x	x
Auch in Toleranzklasse 3B/3A verfügbar. Bitte anfragen. Also available in tolerance class 3B/3A. Please enquire.						

Prüfprotokolle werden extra berechnet, siehe Hinweise Seite L21  
 Certificates will be charged separately, please see remarks page L21

x = ab Lager, Zwischenverkauf vorbehalten  
 x = normally ex stock

LS = Lehenstahl / Toolsteel

# HAHNREITER Gewindelehren

## Thread Gauges

### G

#### Whitworth Rohrgewinde DIN ISO 228

Lehrenmaße DIN ISO 228, Teil 2

#### Whitworth Pipe Threads DIN ISO 228

Gauge sizes DIN ISO 228, part 2

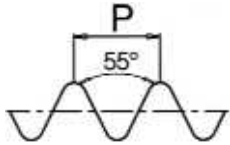

Katalog Nr. Bezeichnung	Catalogue No. Name	L14 000 Grenz- Lehrdorn <i>Limit Plug Gauge</i>	L14 100 Gut- Lehrdorn <i>Plug Gauge Go</i>	L14 200 Ausschuss- Lehrdorn <i>Plug Gauge NoGo</i>	L14 005 Grenz- Lehrdorn <i>Limit Plug Gauge</i>	L14 400 Gut- Lehrring <i>Ring Gauge Go</i>	L14 500 Ausschuss- Lehrring <i>Ring Gauge NoGo</i>
Toleranz	<i>Tolerance</i>						
Werkstoff	<i>Material</i>	LS	LS	LS	LS	A LS	A LS
Oberfläche	<i>Surface</i>				CrB2*		
Ausführung	<i>Variation</i>						
d <sub>1</sub>	P Gg/1"	Verfügbarkeit <i>Availability</i>					
	Ø mm						
G 1/8	28	09,73	x	x	x	x	x
G 1/4	19	13,16	x	x	x	x	x
G 3/8	19	16,66	x	x	x	x	x
G 1/2	14	20,96	x	x	x	x	x
G 5/8	14	22,91	x	x	x	x	x
G 3/4	14	26,44	x	x	x	x	x
G 7/8	14	30,20	x	x	x	x	x
G 1	11	33,25	x	x	x	x	x
G 1.1/8	11	37,90	x	x	x	x	x
G 1.1/4	11	41,91		x	x	x	x
G 1.1/2	11	47,80		x	x	x	x
G 1.3/4	11	53,75		x	x	x	x
G 2	11	59,61		x	x	x	x
G 2.1/4	11	65,71		x	x	x	x
G 2.1/2	11	75,18		x	x	x	x
G 2.3/4	11	81,53		x	x	x	x
G 3	11	87,88		x	x	x	x
G 3.1/2	11	100,33		x	x	x	x
G 4	11	113,00		x	x	x	x
Technische Informationen zum Thema Rohrgewinde siehe Seite T20 <i>For technical information concerning pipe threads, please see page T22</i>							

Prüfprotokolle werden extra berechnet, siehe Hinweise Seite L21  
*Certificates will be charged separately, please see remarks page L21*

x = ab Lager, Zwischenverkauf vorbehalten  
 x = normally ex stock

\* solange Lagervorrat liefern wir TiCN Ausführung  
 \* as long available we will send TiCN version

LS = Lehenstahl / Toolsteel

# HAHNREITER Gewindelehren

## Thread Gauges

### Rp/Rc / R

**Whitworth Rohrgewinde**  
 zylindrisches Innengewinde  
 kegeliges Außengewinde  
**Whitworth Pipe Threads**  
 Cylindrical internal threads  
 Taper external threads

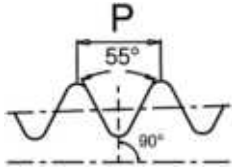

DIN EN  
10226-3,  
+ ISO 7/2

DIN 2999  
zurückgezogen  
withdrawn

DIN EN  
10226-3,  
+ ISO 7/2

DIN 2999  
zurückgezogen  
withdrawn

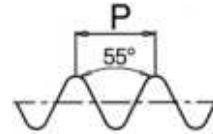

Katalog Nr. Bezeichnung	Catalogue No. Name	L24 000 Grenz- Lehrdorn Limit Plug Gauge	L23 000 Grenz- Lehrdorn Limit Plug Gauge			L24 300 Grenz- Lehrhring Limit Ring Gauge	L23 300 Grenz- Lehrhring Limit Ring Gauge
Werkstoff	Material	Rp/Rc LS	Rp/Rc LS			R LS	R LS
Lehre Nr.	Gauge no.	1				3	
Ausführung der Lehre	Variation of Gauge	kegelig taper	kegelig taper			zylindrisch cylindrical	zylindrisch cylindrical
d <sub>1</sub>	P Gg/1"    Ø mm	Verfügbarkeit Availability	Verfügbarkeit Availability		d <sub>1</sub>	Verfügbarkeit Availability	Verfügbarkeit Availability
Rp/Rc 1/8	28 09,73	x	x		R 1/8	x	x
Rp/Rc 1/4	19 13,16	x	x		R 1/4	x	x
Rp/Rc 3/8	19 16,66	x	x		R 3/8	x	x
Rp/Rc 1/2	14 20,96	x	x		R 1/2	x	x
Rp/Rc 3/4	14 26,44	x	x		R 3/4	x	x
Rp/Rc 1	11 33,25	x	x		R 1	x	x
Rp/Rc 1.1/4	11 41,91	x	x		R 1.1/4	x	x
Rp/Rc 1.1/2	11 47,80	x	x		R 1.1/2	x	x
Rp/Rc 2	11 59,61	x	x		R 2	x	x
Rp/Rc 2.1/2	11 75,18	x	x		R 2.1/2	x	x
Rp/Rc 3	11 87,88	x	x		R 3	x	x
Rp/Rc 4	11 113,00	x	x		R 4	x	x
DIN 2999 wurde zurückgezogen und durch DIN EN 10226 ersetzt. Teil 3 für Lehren ist gleich mit ISO 7/2 aber geringfügig unterschiedlich zu DIN 2999. DIN 2999 was withdrawn and replaced by DIN EN 10226. Part 3 for gauges is similar to ISO 7/2 but different to DIN 2999.							
Technische Informationen zum Thema Rohrgewinde siehe Seite T20 For technical information concerning pipe threads, please see page T22							

Prüfprotokolle werden extra berechnet, siehe Hinweis Seite L21  
 Certificates will be charged separately, please see remarks page L21

x = ab Lager, Zwischenverkauf vorbehalten  
 x = normally ex stock

LS = Lehenstahl / Toolsteel

# HAHNREITER Gewindelehren

## Thread Gauges

### NPT

**Amerikanisches Kegeliges Rohrgewinde - Konus 1 : 16**

ANSI/ASME B 1.20.1 - 1983, "allg. Verwendung"

**American Taper Pipe Thread, Taper 1 : 16**

ANSI/ASME B 1.20.1 - 1983, "general purpose"

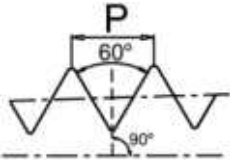

Katalog Nr. Bezeichnung	Catalogue No. Name			L17 000 Grenz- Lehrdorn Limit Plug Gauge		L17 300 Grenz- Lehrring Limit Ring Gauge	
Werkstoff	Material			LS		LS	
Oberfläche	Surface						
Ausführung der Lehre	Variation of Gauge			kegelig taper		kegelig taper	
d <sub>1</sub>	P Gg/1"	code	Verfügbarkeit Availability				
1/16	- 27	08,85		x		x	
1/8	- 27	10,62		x		x	
1/4	- 18	14,14		x		x	
3/8	- 18	17,57		x		x	
1/2	- 14	21,90		x		x	
3/4	- 14	27,23		x		x	
1	- 11,5	34,18		x		x	
1.1/4	- 11,5	42,90		x		x	
1.1/2	- 11,5	48,94		x		x	
2	- 11,5	61,00		x		x	
Technische Informationen zum Thema Rohrgewinde siehe Seite T20 For technical information concerning pipe threads, please see page T22							

Prüfprotokolle werden extra berechnet, siehe Hinweis Seite L21  
Certificates will be charged separately, please see remarks page L21

**x = ab Lager, Zwischenverkauf vorbehalten**  
x = normally ex stock

LS = Lehenstahl / Toolsteel

# HAHNREITER Gewindelehren

## Thread Gauges

### NPTF

**Amerikanisches Kegeliges Rohrgewinde - Konus 1 : 16**

ANSI/ASME B 1.20.3 - 1976 (R.1982), "trocken dichtend"

**American Taper Pipe Thread, Taper 1 : 16**

ANSI/ASME B 1.20.3 - 1976 (R.1982), "dry sealing"

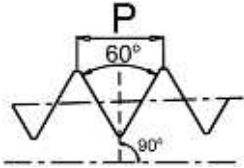

Katalog Nr. Bezeichnung	Catalogue No. Name			L18 000 Grenz- Lehrdorn Limit Plug Gauge		L18 300 Grenz- Lehrring Limit Ring Gauge	
Werkstoff	Material			LS		LS	
Oberfläche	Surface						
Ausführung	Variation			kegelig taper		kegelig taper	
d <sub>1</sub>	P Gg/1"	code	Verfügbarkeit Availability				
1/16	- 27	08,85		x		x	
1/8	- 27	10,62		x		x	
1/4	- 18	14,14		x		x	
3/8	- 18	17,57		x		x	
1/2	- 14	21,90		x		x	
3/4	- 14	27,23		x		x	
1	- 11,5	34,18		x		x	
1.1/4	- 11,5	42,90		x		x	
1.1/2	- 11,5	48,94		x		x	
2	- 11,5	61,00		x		x	
<p>Diese Gewindegrenzlehren prüfen die Flankendurchmesser. Zur vollständigen Prüfung des gesamten Profils bei Klasse 2 Gewinden muss ein mehrteiliger Lehrensatz für Aussen-Ø und Kern-Ø verwendet werden. Auf Anfrage lieferbar.  <i>These Limit-Thread-Gauges check the pitch diameter. For a complete check of the whole profile of class 2 threads, you need a multi set for crest and root. Available on request.</i></p>							
<p>Technische Informationen zum Thema Rohrgewinde siehe Seite T21  <i>For technical information concerning pipe threads, please see page T23</i></p>							

Prüfprotokolle werden extra berechnet, siehe Hinweis Seite L21  
*Certificates will be charged separately, please see remarks page L21*

**x = ab Lager, Zwischenverkauf vorbehalten**  
*x = normally ex stock*

LS = Lehenstahl / Toolsteel



# HAHNREITER Gewindelehren

## Thread Gauges

### Tr

Metrisches ISO Trapezgewinde, DIN 103

Lehrenmaße DIN 103, Teil 9

**Metric ISO Trapezoidal Threads DIN 103**

Gauge size DIN 103, part 9

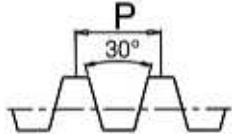

Katalog Nr. Bezeichnung	Catalogue No. Name	L21 000 Grenz- Lehrdorn <i>Limit Plug Gauge</i>	L21 100 Gut- Lehrdorn <i>Plug Gauge, Go</i>	L21 200 Ausschuss- Lehrdorn <i>Plug Gauge, NoGo</i>		L21 400 Gut- Lehrring <i>Ring Gauge Go</i>	L21 500 Ausschuss- Lehrring <i>Ring Gauge NoGo</i>
Toleranz	<i>Tolerance</i>	7H	7H	7H		7e	7e
Werkstoff	<i>Material</i>	LS	LS	LS		LS	LS
Oberfläche	<i>Surface</i>						
Ausführung	<i>Variation</i>						
d <sub>1</sub>	P mm	Code	Verfügbarkeit <i>Availability</i>				
Tr 8	x 1,5	0815	x	x	x	x	x
Tr 9	x 2	092	x	x	x	x	x
Tr 10	x 2	102	x	x	x	x	x
Tr 11	x 2	112	x	x	x	x	x
Tr 12	x 3	123	x	x	x	x	x
Tr 14	x 3	143	x	x	x	x	x
Tr 16	x 4	164	x	x	x	x	x
Tr 18	x 4	184	x	x	x	x	x
Tr 20	x 4	204	x	x	x	x	x
Tr 22	x 5	225	x	x	x	x	x
Tr 24	x 5	245	x	x	x	x	x
Tr 26	x 5	265	x	x	x	x	x
Tr 28	x 5	285	x	x	x	x	x
Tr 30	x 6	306	x	x	x	x	x
Tr 32	x 6	326	x	x	x	x	x
Tr 34	x 6	346	x	x	x	x	x
Tr 36	x 6	366	x	x	x	x	x
Tr 40	x 7	407	x	x	x	x	x

Prüfprotokolle werden extra berechnet, siehe Hinweis Seite L21  
*Certificates will be charged separately, please see remarks page L21*

**x = ab Lager, Zwischenverkauf vorbehalten**  
*x = normally ex stock*

LS = Lehenstahl / Toolsteel

# HAHNREITER Gewindelehren

## Thread Gauges

### Rd

**Rundgewinde DIN 405**  
 Lehrenmaße DIN 405, Teil 3  
**Round Threads DIN 405**  
 Gauge size DIN 405, part 3

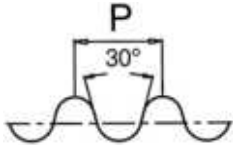

Katalog Nr. Bezeichnung	Catalogue No. Name	L22 000 Grenz- Lehrdorn Limit Plug Gauge	L22 100 Gut- Lehrdorn Plug Gauge, Go	L22 200 Ausschuss- Lehrdorn Plug Gauge, NoGo		L22 400 Gut- Lehrring Ring Gauge Go	L22 500 Ausschuss- Lehrring Ring Gauge NoGo
Toleranz	Tolerance	7H	7H	7H		7h	7h
Werkstoff	Material	LS	LS	LS		LS	LS
Oberfläche	Surface						
Ausführung	Variation						
d <sub>1</sub>	P mm	Code	Verfügbarkeit Availability				
Rd 8	x 1/10	08	<input type="checkbox"/>	<input type="checkbox"/>	<input type="checkbox"/>	<input type="checkbox"/>	<input type="checkbox"/>
Rd 9	x 1/10	09	<input type="checkbox"/>	<input type="checkbox"/>	<input type="checkbox"/>	<input type="checkbox"/>	<input type="checkbox"/>
Rd 10	x 1/10	10	<input type="checkbox"/>	<input type="checkbox"/>	<input type="checkbox"/>	<input type="checkbox"/>	<input type="checkbox"/>
Rd 11	x 1/10	11	<input type="checkbox"/>	<input type="checkbox"/>	<input type="checkbox"/>	<input type="checkbox"/>	<input type="checkbox"/>
Rd 12	x 1/10	12	<input type="checkbox"/>	<input type="checkbox"/>	<input type="checkbox"/>	<input type="checkbox"/>	<input type="checkbox"/>
Rd 14	x 1/8	14	<input type="checkbox"/>	<input type="checkbox"/>	<input type="checkbox"/>	<input type="checkbox"/>	<input type="checkbox"/>
Rd 16	x 1/8	16	<input type="checkbox"/>	<input type="checkbox"/>	<input type="checkbox"/>	<input type="checkbox"/>	<input type="checkbox"/>
Rd 18	x 1/8	18	<input type="checkbox"/>	<input type="checkbox"/>	<input type="checkbox"/>	<input type="checkbox"/>	<input type="checkbox"/>
Rd 20	x 1/8	20	<input type="checkbox"/>	<input type="checkbox"/>	<input type="checkbox"/>	<input type="checkbox"/>	<input type="checkbox"/>
Rd 22	x 1/8	22	<input type="checkbox"/>	<input type="checkbox"/>	<input type="checkbox"/>	<input type="checkbox"/>	<input type="checkbox"/>
Rd 24	x 1/8	24	<input type="checkbox"/>	<input type="checkbox"/>	<input type="checkbox"/>	<input type="checkbox"/>	<input type="checkbox"/>
Rd 26	x 1/8	26	<input type="checkbox"/>	<input type="checkbox"/>	<input type="checkbox"/>	<input type="checkbox"/>	<input type="checkbox"/>
Rd 28	x 1/8	28	<input type="checkbox"/>	<input type="checkbox"/>	<input type="checkbox"/>	<input type="checkbox"/>	<input type="checkbox"/>
Rd 30	x 1/8	30	<input type="checkbox"/>	<input type="checkbox"/>	<input type="checkbox"/>	<input type="checkbox"/>	<input type="checkbox"/>

Prüfprotokolle werden extra berechnet, siehe Hinweise Seite L21  
 Certificates will be charged separately, please see remarks page L21

LS = Lehenstahl / Toolsteel

x = ab Lager, Zwischenverkauf vorbehalten  
 x = normally ex stock

= Verfügbar auf Anfrage  
 = available on request

# HAHNREITER Gewindelehren

## Thread Gauges

### PG

Stahlpanzerrohr-Gewinde, DIN 40430

Lehrenmaße DIN 40431

Steel Conduit Thread, DIN 40430

Gauge size DIN 40431

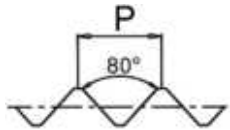

Katalog Nr. Bezeichnung	Catalogue No. Name	L19 000 Grenz- Lehrdorn Limit Plug Gauge	L19 400 Gut- Lehrring Ring Gauge Go	L19 500 Ausschuss- Lehrring Ring Gauge NoGo		
Werkstoff	Material	LS	LS	LS		
Oberfläche	Surface					
Ausführung	Variation	Ausschuss-Seite glatt NoGo plain		glatt plain		
d <sub>1</sub>	P Gg/1"	Ø mm	Verfügbarkeit Availability			
Pg 7	20	12,50	o	o	o	
Pg 9	18	15,20	o	o	o	
Pg 11	18	18,60	o	o	o	
Pg 13,5	18	20,40	o	o	o	
Pg 16	18	22,50	o	o	o	
Pg 21	16	28,30	o	o	o	
Pg 29	16	37,00	o	o	o	
Pg 36	16	47,00	o	o	o	
Pg 42	16	54,00	o	o	o	
Pg 48	16	59,30	o	o	o	

Für Elektroinstallationsrohre ist nach DIN EN 60423 das PG Gewinde durch Metrisches Feingewinde ersetzt worden,  
Für Neukonstruktionen sollte PG Gewinde daher nicht mehr verwendet werden.

For "Conduits for electrical purposes" according to DIN EN 60423 the PG thread was replaced by Metric Fine Thread,  
PG thread should not be used for new applications.

Prüfprotokolle werden extra berechnet, siehe Hinweis Seite L21  
Certificates will be charged separately, please see remarks page L21

o = nur solange Lagervorrat vorhanden  
o = available while stocks last

LS = Lehenstahl / Toolsteel

**Grenzlehrdorne / Limit Plug Gauges**

**zylindrisch**

Baumaße DIN 2245,

Lehrenmaße DIN EN ISO 1938-1

**cylindrical**

Dimensions DIN 2245

Gauge sizes DIN EN ISO 1938-1



Katalog Nr. Bezeichnung	Catalogue No. Name		L50 000 Grenz- Lehrdorn Limit Plug Gauge			L50 000 Grenz- Lehrdorn Limit Plug Gauge	
Toleranz	Tolerance		H7			H7	
Werkstoff	Material		LS			LS	
		Ø mm	Verfügbarkeit Availability			Ø mm	Verfügbarkeit Availability
		1,0	x			34,0	x
		1,2	x			35,0	x
		1,5	x			36,0	x
		1,8	x			37,0	x
		2,0	x			38,0	x
		2,2	x			40,0	x
		2,5	x			42,0	x
		2,8	x			44,0	x
		3,0	x			45,0	x
		3,5	x			46,0	x
		4,0	x			47,0	x
		4,5	x			48,0	x
		5,0	x			50,0	x
		5,5	x			52,0	x
		6,0	x			55,0	x
		7,0	x			58,0	x
		8,0	x			60,0	x
		9,0	x			62,0	x
		10,0	x			65,0	x
		11,0	x			68,0	x
		12,0	x			70,0	x
		13,0	x			72,0	x
		14,0	x			75,0	x
		15,0	x			78,0	x
		16,0	x			80,0	x
		17,0	x				
		18,0	x				
		19,0	x				
		20,0	x				
		21,0	x				
		22,0	x				
		23,0	x				
		24,0	x				
		25,0	x				
		26,0	x				
		27,0	x				
		28,0	x				
		30,0	x				
		32,0	x				
		33,0	x				
						Größere Ø, Zwischenmaße und andere Toleranzen auf Anfrage. Other sizes and tolerances on request.	

Prüfprotokolle werden extra berechnet, siehe Hinweis Seite L21  
 Certificates will be charged separately, please see remarks page L21

x = ab Lager, Zwischenverkauf vorbehalten  
 x = normally ex stock

LS = Lehenstahl / Toolsteel

## Lehrringe / Ring Gauges

zylindrisch

Baumaße DIN 2250 / DIN 2254

Lehrenmaße DIN EN ISO 1938-1

*cylindrical*

*Dimensions DIN 2250 / DIN 2254*

*Gauge sizes DIN EN ISO 1938-1*



Katalog Nr. Bezeichnung	Catalogue No. Name	L50 300 Einstellring <i>Setting Ring</i>	L50 400 Gut- Lehrring <i>Ring Gauge Go</i>	L50 500 Ausschuss- Lehrring <i>Ring Gauge NoGo</i>		L50 300 Einstellring <i>Setting Ring</i>	L50 400 Gut- Lehrring <i>Ring Gauge Go</i>	L50 500 Ausschuss- Lehrring <i>Ring Gauge NoGo</i>	
Toleranz	<i>Tolerance</i>	JS4	**	**		JS4	**	**	
Werkstoff	<i>Material</i>	LS	LS	LS		LS	LS	LS	
Ausführung	<i>Variation</i>	DIN 2250-C 2008-10	DIN 2250 G	DIN 2254		DIN 2250-C 2008-10	DIN 2250 G	DIN 2254	
		∅ mm	Verfügbarkeit <i>Availability</i>			∅ mm	Verfügbarkeit <i>Availability</i>		
** Gewünschte Toleranz bei Bestellung angeben. ** <i>Specify tolerance with order.</i>		1,0	<input type="checkbox"/>	<input type="checkbox"/>	<input type="checkbox"/>	34,0	<input checked="" type="checkbox"/>	<input checked="" type="checkbox"/>	<input checked="" type="checkbox"/>
		1,2	<input type="checkbox"/>	<input type="checkbox"/>	<input type="checkbox"/>	35,0	<input checked="" type="checkbox"/>	<input checked="" type="checkbox"/>	<input checked="" type="checkbox"/>
		1,5	<input type="checkbox"/>	<input type="checkbox"/>	<input type="checkbox"/>	36,0	<input checked="" type="checkbox"/>	<input checked="" type="checkbox"/>	<input checked="" type="checkbox"/>
		1,8	<input type="checkbox"/>	<input type="checkbox"/>	<input type="checkbox"/>	37,0	<input checked="" type="checkbox"/>	<input checked="" type="checkbox"/>	<input checked="" type="checkbox"/>
		2,0	<input type="checkbox"/>	<input type="checkbox"/>	<input type="checkbox"/>	38,0	<input checked="" type="checkbox"/>	<input checked="" type="checkbox"/>	<input checked="" type="checkbox"/>
		2,2	<input type="checkbox"/>	<input type="checkbox"/>	<input type="checkbox"/>	40,0	<input checked="" type="checkbox"/>	<input checked="" type="checkbox"/>	<input checked="" type="checkbox"/>
		2,5	<input type="checkbox"/>	<input type="checkbox"/>	<input type="checkbox"/>	42,0	<input checked="" type="checkbox"/>	<input checked="" type="checkbox"/>	<input checked="" type="checkbox"/>
		2,8	<input type="checkbox"/>	<input type="checkbox"/>	<input type="checkbox"/>	44,0	<input checked="" type="checkbox"/>	<input checked="" type="checkbox"/>	<input checked="" type="checkbox"/>
		3,0	<input type="checkbox"/>	<input type="checkbox"/>	<input type="checkbox"/>	45,0	<input checked="" type="checkbox"/>	<input checked="" type="checkbox"/>	<input checked="" type="checkbox"/>
		3,5	<input checked="" type="checkbox"/>	<input checked="" type="checkbox"/>	<input checked="" type="checkbox"/>	46,0	<input checked="" type="checkbox"/>	<input checked="" type="checkbox"/>	<input checked="" type="checkbox"/>
		4,0	<input checked="" type="checkbox"/>	<input checked="" type="checkbox"/>	<input checked="" type="checkbox"/>	47,0	<input checked="" type="checkbox"/>	<input checked="" type="checkbox"/>	<input checked="" type="checkbox"/>
		4,5	<input checked="" type="checkbox"/>	<input checked="" type="checkbox"/>	<input checked="" type="checkbox"/>	48,0	<input checked="" type="checkbox"/>	<input checked="" type="checkbox"/>	<input checked="" type="checkbox"/>
		5,0	<input checked="" type="checkbox"/>	<input checked="" type="checkbox"/>	<input checked="" type="checkbox"/>	50,0	<input checked="" type="checkbox"/>	<input checked="" type="checkbox"/>	<input checked="" type="checkbox"/>
		5,5				52,0	<input checked="" type="checkbox"/>	<input checked="" type="checkbox"/>	<input checked="" type="checkbox"/>
		6,0	<input checked="" type="checkbox"/>	<input checked="" type="checkbox"/>	<input checked="" type="checkbox"/>	55,0	<input checked="" type="checkbox"/>	<input checked="" type="checkbox"/>	<input checked="" type="checkbox"/>
		7,0	<input checked="" type="checkbox"/>	<input checked="" type="checkbox"/>	<input checked="" type="checkbox"/>	58,0	<input checked="" type="checkbox"/>	<input checked="" type="checkbox"/>	<input checked="" type="checkbox"/>
		8,0	<input checked="" type="checkbox"/>	<input checked="" type="checkbox"/>	<input checked="" type="checkbox"/>	60,0	<input checked="" type="checkbox"/>	<input checked="" type="checkbox"/>	<input checked="" type="checkbox"/>
		9,0	<input checked="" type="checkbox"/>	<input checked="" type="checkbox"/>	<input checked="" type="checkbox"/>	62,0	<input checked="" type="checkbox"/>	<input checked="" type="checkbox"/>	<input checked="" type="checkbox"/>
		10,0	<input checked="" type="checkbox"/>	<input checked="" type="checkbox"/>	<input checked="" type="checkbox"/>	65,0	<input checked="" type="checkbox"/>	<input checked="" type="checkbox"/>	<input checked="" type="checkbox"/>
		11,0	<input checked="" type="checkbox"/>	<input checked="" type="checkbox"/>	<input checked="" type="checkbox"/>	68,0	<input checked="" type="checkbox"/>	<input checked="" type="checkbox"/>	<input checked="" type="checkbox"/>
		12,0	<input checked="" type="checkbox"/>	<input checked="" type="checkbox"/>	<input checked="" type="checkbox"/>	70,0	<input checked="" type="checkbox"/>	<input checked="" type="checkbox"/>	<input checked="" type="checkbox"/>
		13,0	<input checked="" type="checkbox"/>	<input checked="" type="checkbox"/>	<input checked="" type="checkbox"/>	72,0	<input checked="" type="checkbox"/>	<input checked="" type="checkbox"/>	<input checked="" type="checkbox"/>
		14,0	<input checked="" type="checkbox"/>	<input checked="" type="checkbox"/>	<input checked="" type="checkbox"/>	75,0	<input checked="" type="checkbox"/>	<input checked="" type="checkbox"/>	<input checked="" type="checkbox"/>
		15,0	<input checked="" type="checkbox"/>	<input checked="" type="checkbox"/>	<input checked="" type="checkbox"/>	78,0	<input checked="" type="checkbox"/>	<input checked="" type="checkbox"/>	<input checked="" type="checkbox"/>
		16,0	<input checked="" type="checkbox"/>	<input checked="" type="checkbox"/>	<input checked="" type="checkbox"/>	80,0	<input checked="" type="checkbox"/>	<input checked="" type="checkbox"/>	<input checked="" type="checkbox"/>
		17,0	<input checked="" type="checkbox"/>	<input checked="" type="checkbox"/>	<input checked="" type="checkbox"/>				
		18,0	<input checked="" type="checkbox"/>	<input checked="" type="checkbox"/>	<input checked="" type="checkbox"/>				
		19,0	<input checked="" type="checkbox"/>	<input checked="" type="checkbox"/>	<input checked="" type="checkbox"/>				
		20,0	<input checked="" type="checkbox"/>	<input checked="" type="checkbox"/>	<input checked="" type="checkbox"/>				
		21,0	<input checked="" type="checkbox"/>	<input checked="" type="checkbox"/>	<input checked="" type="checkbox"/>				
		22,0	<input checked="" type="checkbox"/>	<input checked="" type="checkbox"/>	<input checked="" type="checkbox"/>				
		23,0	<input checked="" type="checkbox"/>	<input checked="" type="checkbox"/>	<input checked="" type="checkbox"/>				
		24,0	<input checked="" type="checkbox"/>	<input checked="" type="checkbox"/>	<input checked="" type="checkbox"/>				
		25,0	<input checked="" type="checkbox"/>	<input checked="" type="checkbox"/>	<input checked="" type="checkbox"/>				
		26,0	<input checked="" type="checkbox"/>	<input checked="" type="checkbox"/>	<input checked="" type="checkbox"/>				
		27,0	<input checked="" type="checkbox"/>	<input checked="" type="checkbox"/>	<input checked="" type="checkbox"/>				
		28,0	<input checked="" type="checkbox"/>	<input checked="" type="checkbox"/>	<input checked="" type="checkbox"/>				
		30,0	<input checked="" type="checkbox"/>	<input checked="" type="checkbox"/>	<input checked="" type="checkbox"/>				
		32,0	<input checked="" type="checkbox"/>	<input checked="" type="checkbox"/>	<input checked="" type="checkbox"/>				
		33,0	<input checked="" type="checkbox"/>	<input checked="" type="checkbox"/>	<input checked="" type="checkbox"/>				
							Größere ∅, Zwischenmaße und andere Toleranzen auf Anfrage. <i>Other sizes and tolerances on request.</i>		

Prüfprotokolle werden extra berechnet, siehe Hinweise Seite L21  
*Certificates will be charged separately, please see remarks page L21*

LS = Lehenstahl / *Toolsteel*

**x = ab Lager, Zwischenverkauf vorbehalten**  
*x = normally ex stock*

**☐ = Verfügbar auf Anfrage**  
*☐ = available on request*

# HAHNREITER Lehren - Prüfprotokolle (Neuprüfung)

## Thread Gauges - Certificates (New products)



Katalog Nr. Type	L77 000 Grenz- Lehrdorn <i>Limit Plug Gauge</i>	L77 001 Gut- Lehrdorn <i>Plug Gauge Go</i>	L77 002 Ausschuss- Lehrdorn <i>Plug Gauge NoGo</i>	L77 003 Gut- Lehrring <i>Ring Gauge Go</i>	L77 004 Ausschuss- Lehrring <i>Ring Gauge NoGo</i>	L77 005 Kegelige Dorn <i>Taper Threadgauge Plug</i>	L77 006 Gewindelehren Ring <i>Ring Ring</i>	L77 100 Grenz- Lehrdorn <i>Limit Plug Gauge</i>	L77 103 Lehrringe zyl. <i>Ring Gauge cyl.</i>
Ausführung Variation						konisch taper	konisch taper	zylindrisch cylindrical	zylindrisch cylindrical
Ø mm	Code Nr. Code no.								
1 - 40 > 40 - 150	01	04 05	04 05						
1 - 70 > 70 - 150				10 11	10 11				
1 - 43 > 43 - 113						20 21	20 21		
0 - 40 > 40 - 150								30 31	
1 - 10 > 10 - 50 > 50 - 150									40 41 42
	Zusätzliche Beschriftung für alle Typen gegen Berechnung möglich. <b>Code Nr. L77 900</b>								

Die Prüfung erfolgt nach den Richtlinien VDI/VDE/DGQ 2618, Blatt 1-27.

Das Prüfprotokoll entspricht den Anforderungen der DIN/ISO 9000 ff.

Die zur Messung eingesetzten Meßmittel werden regelmäßig mit DKD-kalibrierten Normalen verglichen und gewährleisten somit höchste Qualitätsanforderungen. Der Maßanschluss an nationale Normale wird über einen DKD-kalibrierten Parallelendmaßsatz realisiert. Die jeweils gültige Kalibrierungs-Nummer ist in den Prüfprotokollen aufgeführt.



## HAHNREITER Lehren - Überwachungsprüfung *Thread Gauges - Control check Certification (of used gauges)*

Wir übernehmen für Sie die Überprüfung Ihrer angelieferten Lehren und erstellen ein Prüfprotokoll. Diese Serviceleistung besteht aus:

- Reinigung der zu überprüfenden Lehren
- Prüfen auf äußere Beschädigungen
- Kontrolle der Lehrenfunktionsmaße
- Erstellung eines Prüfprotokolls

Die Prüfung erfolgt nach den Richtlinien VDI/VDE/DGQ 2618, Blatt 1-27. Das Prüfprotokoll entspricht den Anforderungen DIN/ISO 9000 ff.

Die zur Messung eingesetzten Messmittel werden regelmäßig mit DKD-kalibrierten Normalen verglichen und gewährleisten somit höchste Qualitätsanforderungen. Der Maßanschluss an nationale Normale wird über einen DKD-kalibrierten Parallelendmaßsatz realisiert. Die jeweils gültige Kalibrierungs-Nummer ist in den Prüfprotokollen aufgeführt.

Unser Lehrenservice umfasst folgende Lehrenarten:

- Gewindelehrrdorne
- Gewindelehrringe
- kegelige Gewindelehren
- zyl. Lehrrdorne
- Lehrringe
- alle weiteren Lehren auf Anfrage

Die in unserer separaten Preisliste angegebenen Nettopreise beziehen sich ausschließlich auf Katalogartikel. Überwachungsprüfungen für Sonderartikel werden nach Aufwand abgerechnet.

Sollte sich bei der Reinigung und Sichtkontrolle herausstellen, dass die Lehre so beschädigt ist, dass eine fachgerechte Zertifizierung nicht möglich ist, wird für die Kontrolle eine Gebühr berechnet. Wenn die Instandsetzung möglich ist, wird Ihnen ein Kostenvoranschlag für die Nacharbeit unterbreitet.

Auf Wunsch werden die Lehren gegen Berechnung mit einer Ident-Nr. versehen, die auf Lehre und Prüfzeugnis vermerkt ist. Falls die Lehren in ungeeigneter Verpackung angeliefert werden, erfolgt der Rückversand in Spezialverpackung gegen Berechnung.

Mindestauftragshöhe: € 50,00 netto

Preise: freie Anlieferung Auf dem Knapp 34, 42855 Remscheid  
unfreie Rücksendung

Zahlung: Lohnarbeit sofort rein netto ohne Abzug

Preise siehe jeweils gültige separate Preisliste.

# HAHNREITER Lehren - Überwachungsprüfung

## Thread Gauges - Control check Certification (of used gauges)



Katalog Nr. Type	L88 000 Grenz- Lehrdorn <i>Limit Plug Gauge</i>	L88 001 Gut- Lehrdorn <i>Plug Gauge Go</i>	L88 002 Ausschuss- Lehrdorn <i>Plug Gauge NoGo</i>	L88 003 Gut- Lehrring <i>Ring Gauge Go</i>	L88 004 Ausschuss- Lehrring <i>Ring Gauge NoGo</i>	L88 005 Kegelige Dorn <i>Taper Threadgauge Plug</i>	L88 006 Gewindelehren Ring <i>Ring Gauge</i>	L88 100 Grenz- Lehrdorn <i>Limit Plug Gauge</i>	L88 103 Lehrringe zyl. <i>Ring Gauge cyl.</i>
Ausführung Variation						konisch taper	konisch taper	zylindrisch cylindrical	zylindrisch cylindrical
Ø mm	Code Nr. Code no.								
1 - 3 > 3 - 40 > 40 - 150	01 02 03	01 02 03	01 02 03						
3 - 10 > 10 - 70 > 70 - 200				10 11 12	10 11 12				
1 - 43 > 43 - 113						20 21	20 21		
0 - 40 > 40 - 150								30 31	
1 - 10 > 10 - 50 > 50 - 150									40 41 42
	Zusätzliche Beschriftung für alle Typen gegen Berechnung möglich. <b>Code Nr. L77 900</b> Spezialverpackung nach Aufwand. <b>Code Nr. L77910</b>								

Die Prüfung erfolgt nach den Richtlinien VDI/VDE/DGQ 2618, Blatt 1-27.

Das Prüfprotokoll entspricht den Anforderungen der DIN/ISO 9000 ff.

Die zur Messung eingesetzten Meßmittel werden regelmäßig mit DKD-kalibrierten Normalen verglichen und gewährleisten somit höchste Qualitätsanforderungen. Der Maßanschluss an nationale Normale wird über einen DKD-kalibrierten Parallelendmaßsatz realisiert. Die jeweils gültige Kalibrierungs-Nummer ist in den Prüfprotokollen aufgeführt.

## HAHNREITER Sonderlehren *Special Gauges*



Gewinde-Grenzrollenrachenlehren

*Thread Snap Gauges*



Einstelldorne zum Einstellen von  
Gewinde-Grenzrollenrachenlehren

*Setting Plug Gauges Go/NoGo for adjusting  
Thread Snap Gauges*



Gewinde-Abnutzungsprüfdorne für Gewinde-Gutlehrhinge

*Wear Plug Gauges for Go Ring Gauges*



Gewinde-Prüfdorne für neue feste Gewinde-Gutlehrhinge und  
Gewinde-Ausschusslehrhinge

*Thread Plug Gauges for checking new Go Ring Gauges and  
NoGo Ring Gauges*



Rachenlehren

*Snap Gauges*

**Alle Arten von Sonderlehren und Vorrichtungen nach Ihren Wünschen. Fragen Sie uns an.**

***Special gauges available on request.***

# Technischer Teil

	Seite
Produktbeschreibung Gewindebohrer / Gewindeformer	T2 - T4
Gewinde-Kernloch-Ø und Kern-Ø Muttergewinde	T8 - T14
Beschichtungen	T15
Begriffe und Bezeichnungen an Gewindebohrern / Gewindeformern	T16 - T17
Anschnittformen an Gewindebohrern	T17
Toleranzen am Gewindeteil von Gewindebohrern	T18 - T19
Rohrgewinde	T20 - T21
Einsatzfallbeschreibung Gewindeschneiden - Vordruck	T24
Nachschleifen von Gewindebohrern	T26 - T27
Werkstofftabelle	T29 - T55
Katalog-Nr. Verzeichnis	T56 - T57
Allgemeine Geschäftsbedingungen	T58 - T59

## Technical Index

	Page
<i>Product-Description Taps and Cold Forming Taps</i>	<i>T5 - T7</i>
<i>Drill-Ø for Threads and Minor-Ø of Nut Threads</i>	<i>T8 - T14</i>
<i>Coatings</i>	<i>T15</i>
<i>Terms on Taps</i>	<i>T16 - T17</i>
<i>Chamfer Forms on Taps</i>	<i>T 17</i>
<i>Tolerances on the Thread</i>	<i>T18 - T19</i>
<i>Pipe threads</i>	<i>T22 - T23</i>
<i>Tapping, Specification of Application - Form</i>	<i>T25</i>
<i>Regrinding of Taps</i>	<i>T26 - T27</i>
<i>List of Materials</i>	<i>T29 - T55</i>
<i>List of Catalogue-no's</i>	<i>T56 - T57</i>
<i>Terms</i>	<i>T58 - T59</i>

## Produktbeschreibung HAHNREITER-Gewindebohrer, in alphabetischer Reihenfolge

Bezeichnung	Ausführung	Anwendung	Kernloch
<b>Automat</b>	Gerade Nuten, Anschnittlänge 2-3 Gang (Form C), für Drehautomaten (nur für Rd-Gewinde)	Automatenstahl	Sack- + Durchgangsloch
<b>Automat MS</b>	Gerade Nuten, Anschnittlänge 1,5-2 Gang (Form E), für Drehautomaten	Messing kurzspanend	Sack- + Durchgangsloch
<b>Automat 15</b>	Flache Rechtsspirale 15°, Anschnittlänge 1,5-2 Gang (Form E), für Drehautomaten, Oberflächenbehandlung Vaporisieren vermindert Kaltaufschweissungen	Automatenstahl	Sack- + Durchgangsloch
<b>Automat 20</b>	Flache Rechtsspirale 20°, Anschnittlänge 1,5-2 Gang (Form E), für Drehautomaten	Automatenstahl	Sackloch
<b>Automat 20 MS-Z</b>	Flache Rechtsspirale 20°, Anschnittlänge 1,5-2 Gang (Form E), für Drehautomaten, Oberflächenbehandlung Vaporisieren vermindert Kaltaufschweissungen	Bleifreie Messinglegierungen	Sackloch
<b>Automat 20 STY</b>	Flache Rechtsspirale 20°, Anschnittlänge 1,5-2 Gang (Form E), für Drehautomaten, Hartstoffbeschichtung STYGIAN, siehe Seite T15	Bleifreie Messinglegierungen, Sonderlegierungen	Sackloch
<b>Automat 20 TiN</b>	Flache Rechtsspirale 20°, Anschnittlänge 1,5-2 Gang (Form E), für Drehautomaten, Hartstoffbeschichtung TiN, siehe Seite T15	Rostfreie Stähle	Sackloch
<b>Drückfix</b>	Gewindeformer zur spanlosen Gewindefertigung, Einlaufkegel 2-3 Gang (Form C), gesonderte Vorbohr-Ø beachten, Verwendung beschichteter Werkzeuge empfohlen,	Werkstoffe mit min 10% Bruchdehnung	Sackloch, Durchgangsloch <1x D
<b>Drückfix N</b>	Gewindeformer mit Schmiernuten, zur spanlosen Gewindefertigung, Einlaufkegel 2-3 Gang (Form C), gesonderte Vorbohr-Ø beachten, Verwendung beschichteter Werkzeuge empfohlen	Werkstoffe mit min 10% Bruchdehnung	Sackloch, Durchgangsloch, ≥ 1 x D
<b>Drückfix TiN</b>	Wie Drückfix, Hartstoffbeschichtung TiN, siehe Seite T15	Werkstoffe mit min 10% Bruchdehnung	Sackloch, Durchgangsloch <1x D
<b>Drückfix N TiN</b>	Wie Drückfix N, Hartstoffbeschichtung TiN, siehe Seite T15	Werkstoffe mit min 10% Bruchdehnung	Sack- + Durchgangsloch ≥ 1 x D
<b>Drückfix IKZ TiN</b>	Gewindeformer mit Schmiernuten, zur spanlosen Gewindefertigung, Einlaufkegel 2-3 Gang (Form C), mit innerer Kühlmittelzufuhr, axial, für optimale Schmierung in Sacklöchern, Hartstoffbeschichtung TiN, siehe Seite T15	Werkstoffe mit min 10% Bruchdehnung	Sackloch ≥ 1 x D
<b>Drückfix N CrB2</b>	Gewindeformer mit Schmiernuten, Einlaufkegel 2-3 Gang (Form C), Hartstoff-Dünnschicht CrB2, siehe Seite T15	Aluminium- und Kupferlegierungen mit min 7% Bruchdehnung	Sack- + Durchgangsloch
<b>Drückfix N HF TiN</b>	Gewindeformer mit Schmiernuten, Einlaufkegel 2-3 Gang (Form C), aus pulvermetallurgisch erzeugtem Schnellstahl hergestellt, Hartstoffbeschichtung TiN, siehe Seite T15	Werkstoffe mit min 10% Bruchdehnung	Sack- + Durchgangsloch
<b>Drückfix N TiCN</b>	Gewindeformer mit Schmiernuten, Einlaufkegel 2-3 Gang (Form C), Hartstoffbeschichtung TiCN, siehe Seite T15	Nichtrostende Stähle mit min 10% Bruchdehnung	Sack- + Durchgangsloch
<b>Dulofix</b>	Gerade Nuten mit Schälanschnitt, Anschnittlänge 4-5 Gang (Form B), Spanabfuhr in Schneidrichtung	Universalbohrer für gut spanbare Werkstoffe	Durchgangsloch
<b>Dulofix AZ</b>	Gerade Nuten mit Schälanschnitt, Anschnittlänge 4-5 Gang (Form B), Gewindebohrer mit ausgesetzten Zähnen, angepasste Geometrie, Spanabfuhr in Schneidrichtung	Zähe und schmierende Werkstoffe	Durchgangsloch
<b>Dulofix HF</b>	Gerade Nuten mit Schälanschnitt, Anschnittlänge 4-5 Gang (Form B), aus pulvermetallurgisch erzeugtem Schnellstahl hergestellt, Spanabfuhr in Schneidrichtung, Hartstoffbeschichtung empfohlen	Hochfeste Stähle und Vergütungsstähle, > 1200 N/mm <sup>2</sup> Festigkeit	Durchgangsloch
<b>Dulofix HF IKZ-R TiCN</b>	Gerade Nuten mit Schälanschnitt, Anschnittlänge 4-5 Gang (Form B), aus pulvermetallurgisch erzeugtem Schnellstahl hergestellt, Spanabfuhr in Schneidrichtung, mit innerer Kühlmittelzufuhr, Austritt radial (seitlich), verbesserte Spanabfuhr und optimale Kühlung, Hartstoffbeschichtung TiCN, siehe Seite T15	Hochfeste Stähle und Vergütungsstähle, > 1200 N/mm <sup>2</sup> Festigkeit	Durchgangsloch
<b>Dulofix HF TiCN</b>	Wie Dulofix HF, Hartstoffbeschichtung TiCN, siehe Seite T15	Hochfeste Stähle und Vergütungsstähle, > 1200 N/mm <sup>2</sup> Festigkeit	Durchgangsloch
<b>Dulofix Ni</b>	Gerade Nuten mit Schälanschnitt, Anschnittlänge 5 Gang (Form B), stabile Ausführung, verstärkter Schaft mit reduziertem Einstich, aus pulvermetallurgisch erzeugtem Schnellstahl hergestellt, Spanabfuhr in Schneidrichtung	Schwer zerspanbare, zäh-harte Werkstoffe, z.B. Nickellegierung Nimonic, Inconel, Hastelloy	Durchgangsloch
<b>Dulofix SYNC TiN</b>	Gerade Nuten mit Schälanschnitt, Anschnittlänge 4-5 Gang (Form B), für die Bearbeitung von Durchgangslöchern in einem breiten Materialspektrum mit erhöhten Schnittgeschwindigkeiten, aus pulvermetallurgisch erzeugtem Schnellstahl hergestellt, Spanabfuhr in Schneidrichtung, mit Weldon Fläche, Schafttoleranz h6. Nur auf CNC Maschinen verwenden, Hartstoffbeschichtung TiN, siehe Seite T15	Langspanende Werkstoffe bis 1.100 N/mm <sup>2</sup>	Durchgangsloch
<b>Dulofix Ti</b>	Gerade Nuten mit Schälanschnitt, Anschnittlänge 5 Gang (Form B), verstärkter Schaft mit reduziertem Einstich, aus pulvermetallurgisch erzeugtem Schnellstahl hergestellt, Spanabfuhr in Schneidrichtung	Titanlegierungen	Durchgangsloch
<b>Dulofix TiCN</b>	Wie Dulofix, Hartstoffbeschichtung TiCN, siehe Seite T15	Stähle 500-800 N/mm <sup>2</sup> Festigkeit, AluGußlegierungen >10%Si	Durchgangsloch
<b>Dulofix TiN</b>	Wie Dulofix, Hartstoffbeschichtung TiN, siehe Seite T15	Für gut spanbare Werkstoffe	Durchgangsloch
<b>Dulofix VAP</b>	Wie Dulofix, Oberflächenbehandlung Vaporisieren vermindert Kaltaufschweissungen	Unlegierte und niedriglegierte Stähle	Durchgangsloch
<b>Dulofix VS</b>	Gerade Nuten mit Schälanschnitt, Anschnittlänge 4-5 Gang (Form B), Spanabfuhr in Schneidrichtung, *für Temper-/Sphäroguss Oberfläche NIT verwenden	Stähle 800-1200 N/mm <sup>2</sup> , *Temperguss, *Spähroguss, CuAl-Legierung langspanend	Durchgangsloch

## Produktbeschreibung HAHNREITER-Gewindebohrer, in alphabetischer Reihenfolge

Bezeichnung	Ausführung	Anwendung	Kernloch
<b>Dulofix 15</b>	Flache Linksspiralnuten 15°, Anschnittlänge 4-5 Gang (Form D), Spanabfuhr in Schneidrichtung, für dünnwandige Werkstücke	Gut spanbare Werkstoffe	Durchgangsloch
<b>Gussfix</b>	Gerade Nuten, Anschnittlänge 2-3 Gang (Form C), Oberflächenbehandlung Nitriert	Grauguss	Sack- + Durchgangsloch
<b>Gussfix IKZ</b>	Gerade Nuten, Anschnittlänge 2-3 Gang (Form C), Oberflächenbehandlung Nitriert, mit innerer Kühlmittelzufuhr, axial, verbesserte Spanabfuhr und optimale Kühlung	Grauguss	Sackloch
<b>Gussfix TiN</b>	Wie Gussfix, Hartstoffbeschichtung TiN, siehe Seite T15	Grauguss	Sack- + Durchgangsloch
<b>Hahnreiter</b>	Gerade Nuten, Anschnittlänge 2-3 Gang (Form C), Späne verbleiben in den Nuten	Für gut spanbare Werkstoffe	flaches Sack- + Durchgangsloch $\leq 1 \times D$
<b>Hahnreiter Ni AZ</b>	Gerade Nuten, Anschnittlänge 2-3 Gang (Form C), Späne verbleiben in den Nuten, stabile Ausführung mit verstärktem Schaft, aus pulvermetallurgisch erzeugtem Schnellstahl hergestellt, Gewindebohrer mit ausgesetzten Zähnen, nur für NPT Gewinde	zähe Nickellegierung, z.B. Nimonic, Inconel, Hastelloy	Sack- + Durchgangsloch
<b>Hahnreiter MS</b>	Gerade Nuten, Anschnittlänge 2-3 Gang (Form C), oder Anschnittlänge 1,5-2 Gang (Form E)	Messing kurzspanend	Sack- + Durchgangsloch
<b>Multifix</b>	Gerade Nuten mit Schälanschnitt, Anschnittlänge 4-5 Gang (Form B), Spanabfuhr in Schneidrichtung, Hartstoffbeschichtung STYGIAN, siehe Seite T15	Werkzeugstähle	Durchgangsloch
<b>Multifix 35</b>	Starke Rechtsspirale 30-40°, Anschnittlänge 2-3 Gang (Form C), Spanabfuhr in Schafrichtung, Hartstoffbeschichtung STYGIAN, siehe Seite T15	Werkzeugstähle	Sackloch
<b>Nirofix</b>	Gerade Nuten mit Schälanschnitt, Anschnittlänge 4-5 Gang (Form B), Spanabfuhr in Schneidrichtung, Oberflächenbehandlung Vaporisieren vermindert Kaltaufschweissungen	Nichtrostende Stähle	Durchgangsloch
<b>Nirofix 15</b>	Flache Rechtsspiralnuten ca. 15°, Anschnittlänge 2-3 Gang (Form C), stabile Ausführung mit verstärktem Schaft, aus pulvermetallurgisch erzeugtem Schnellstahl hergestellt, nur für NPT Gewinde	Nichtrostende Stähle	Sack- + Durchgangsloch
<b>Nirofix 35</b>	Starke Rechtsspirale 30-40°, Anschnittlänge 2-3 Gang (Form C), Spanabfuhr in Schafrichtung, Oberflächenbehandlung Vaporisieren vermindert Kaltaufschweissungen	Nichtrostende Stähle	Sackloch
<b>Nirofix 35 TiN</b>	Wie Nirofix 35, Hartstoffbeschichtung TiN, siehe Seite T15	Nichtrostende Stähle, Temperguss, Sphäroguss	Sackloch
<b>Nirofix 35 TS</b>	Wie Nirofix 35, aber mit abgesetztem Führungsgewinde für tiefe Bohrungen auf Maschinen mit Steigungsführung	Nichtrostende Stähle	Tiefes Sackloch $\leq 3 \times D$
<b>Nirofix 48 STY/WC</b>	Sehr starke Rechtsspirale 45-50°, Anschnittlänge 2-3 Gang (Form C), Spanabfuhr in Schafrichtung, erhöhte Freiwinkel, aus pulvermetallurgisch erzeugtem Schnellstahl hergestellt, Hartstoff-Mehrlagenbeschichtung STYGIAN/WC, siehe Seite T15, Verwendung nur auf Maschinen mit Steigungsführung	Nichtrostende Stähle, austenitisch	Sackloch $\leq 3 \times D$
<b>Nirofix AZ</b>	ähnlich Nirofix, Gewindebohrer mit ausgesetzten Zähnen	Nichtrostende Stähle, zäh und schmierend	Durchgangsloch
<b>Nirofix Z STY/WC</b>	Gerade Nuten mit Schälanschnitt, Anschnittlänge 4-5 Gang (Form B), Spanabfuhr in Schneidrichtung, erhöhte Freiwinkel, Hartstoff-Mehrlagenbeschichtung STYGIAN/WC, siehe Seite T15, für verringerte Reibung und höhere Standzeiten	Nichtrostende Stähle, austenitisch	Durchgangsloch
<b>Nirofix TiN</b>	Wie Nirofix, Hartstoffbeschichtung TiN, siehe Seite T15	Nichtrostende Stähle, Temperguss, Sphäroguss	Durchgangsloch
<b>Spiralo 15</b>	Flache Rechtsspirale 15°, Anschnittlänge 2-3 Gang (Form C), geringe Spanabfuhr in Schafrichtung, vorwiegend für horizontale Bearbeitung	Für gut spanbare Werkstoffe	Sackloch $\leq 1 \times D$ , horizontal $\leq 2 \times D$
<b>Spiralo 15 AZ</b>	Ähnlich Spiralo 15, angepasste Geometrie, Gewindebohrer mit ausgesetzten Zähnen	Zähe und schmierende Werkstoffe	Sackloch $\leq 1 \times D$ , horizontal $\leq 2 \times D$
<b>Spiralo 15 HF TiCN</b>	Flache Rechtsspirale ca. 15°, Anschnittlänge 2-3 Gang (Form C), Spanabfuhr in Schafrichtung, bildet in Werkzeugstählen und mit ausreichend Kühlung kurze Späne, aus pulvermetallurgisch erzeugtem Schnellstahl hergestellt, Schnittgeschwindigkeit 4-8 m/min. Hartstoffbeschichtung TiCN, siehe Seite T15	Werkzeugstähle, Schnellarbeitstähle	Sackloch $\leq 3 \times D$
<b>Spiralo 15 HF IKZ TiCN</b>	Wie Spiralo 15 HF IKZ, zusätzlich mit innerer Kühlmittelzufuhr, axial, für optimierte Kühlung und Spanabfuhr, verstärkt die Bildung von kurzen Spänen	Werkzeugstähle, Schnellarbeitstähle	Sackloch $\leq 3 \times D$
<b>Spiralo 15 IKZ</b>	Flache Rechtsspirale 15°, Anschnittlänge 2-3 Gang (Form C), vorwiegend für waagerechten Einsatz, mit innerer Kühlmittelzufuhr, axial, verbesserte Spanabfuhr in Schafrichtung und optimale Kühlung	Universell für alle Werkstoffe mit ca 500-1200 N/mm <sup>2</sup> Festigkeit	Sackloch $\leq 1 \times D$ , je nach Spanform bis $3 \times D$
<b>Spiralo 15 IKZ TiN</b>	wie Spiralo 15 IKZ, Hartstoffbeschichtung TiN, siehe Seite T15	Universell für alle Werkstoffe mit ca 500-1200 N/mm <sup>2</sup> Festigkeit	Sackloch $\leq 1 \times D$ , je nach Spanform $\leq 3 \times D$
<b>Spiralo 15 Ti AZ</b>	Rechtsspirale 15°, Form C, Anschnittlänge 3 Gang, verstärkter Schaft mit reduziertem Einstich, aus pulvermetallurgisch erzeugtem Schnellstahl hergestellt, ausgesetzte Zähne, Spanabfuhr in Schafrichtung, Oberflächenbehandlung Nitriert	Titanlegierungen	Sackloch
<b>Spiralo 15 TiCN</b>	Wie Spiralo 15, Hartstoffbeschichtung TiCN, siehe Seite T15	Alu-Gusslegierungen >10%Si	Sackloch $\leq 1 \times D$ horizontal $\leq 2 \times D$
<b>Spiralo 15 TiN</b>	Wie Spiralo 15, Hartstoffbeschichtung TiN, siehe Seite T15	Für gut spanbare Werkstoffe	Sackloch $\leq 1 \times D$ horizontal $\leq 2 \times D$



## Produktbeschreibung HAHNREITER-Gewindebohrer, in alphabetischer Reihenfolge

Bezeichnung	Ausführung	Anwendung	Kernloch
<b>Spiralo 25 Ni</b>	Rechtsspirale 25°, Form C, Anschnittlänge 3 Gang, stabile Ausführung, verstärkter Schaft mit reduziertem Einstich, aus pulvermetallurgisch erzeugtem Schnellstahl hergestellt, Spanabfuhr in Schafrichtung	Schwer zerspanbare, zähnharte Werkstoffe, z.B. Nickellegierungen Nimonic, Inconel, Hastelloy	Sackloch
<b>Spiralo 25 Ti</b>	Rechtsspirale 25°, Form C, Anschnittlänge 3 Gang, stabile Ausführung, verstärkter Schaft mit reduziertem Einstich, aus pulvermetallurgisch erzeugtem Schnellstahl hergestellt, Spanabfuhr in Schafrichtung, Oberflächenbehandlung Nitriert	Titanlegierungen	Sackloch
<b>Spiralo 35</b>	Starke Rechtsspirale 30-40°, Anschnittlänge 2-3 Gang (Form C), Spanabfuhr in Schafrichtung	Universalbohrer für gut spanbare Werkstoffe	Sackloch $\leq 2 \times D$
<b>Spiralo 35 AZ</b>	ähnlich Spiralo 35, angepasste Geometrie, Gewindebohrer mit ausgesetzten Zähnen	Zähe und schmierende Werkstoffe	Sackloch $\leq 2 \times D$
<b>Spiralo 35 HF</b>	Starke Rechtsspirale 30-40°, Anschnittlänge 2-3 Gang (Form C), aus pulvermetallurgisch erzeugtem Schnellstahl hergestellt, Spanabfuhr in Schafrichtung, Hartstoffbeschichtung empfohlen	Hochfeste Stähle und Vergütungsstähle, $> 1200 \text{ N/mm}^2$ Festigkeit	Sackloch
<b>Spiralo 35 HF TiCN</b>	Wie Spiralo 35 HF, Hartstoffbeschichtung TiCN, siehe Seite T15	Hochfeste Stähle und Vergütungsstähle, $> 1200 \text{ N/mm}^2$ Festigkeit	Sackloch
<b>Spiralo 35 IKZ</b>	Starke Rechtsspirale 30-40°, Anschnittlänge 2-3 Gang (Form C), Spanabfuhr in Schafrichtung, mit innerer Kühlmittelzufuhr, axial, verbesserte Spanabfuhr in Schafrichtung und optimale Kühlung	Universell für alle Werkstoffe mit ca $500-1200 \text{ N/mm}^2$ Festigkeit	Sackloch $\leq 3 \times D$
<b>Spiralo 35 IKZ TiN</b>	wie Spiralo 35 IKZ, Hartstoffbeschichtung TiN, siehe Seite T15	Universell für alle Werkstoffe mit ca $500-1200 \text{ N/mm}^2$ Festigkeit	Sackloch $\leq 3 \times D$
<b>Spiralo 35 TiCN</b>	Wie Spiralo 35, Hartstoffbeschichtung TiCN, siehe Seite T15	Alu-Gußlegierungen $>10\% \text{Si}$	Sackloch $\leq 2 \times D$
<b>Spiralo 35 TiN</b>	Wie Spiralo 35, Hartstoffbeschichtung TiN, siehe Seite T15	Für gut spanbare Werkstoffe	Sackloch $\leq 2 \times D$
<b>Spiralo 35 TS</b>	Wie Spiralo 35, aber mit abgesetztem Führungsgewinde für tiefe Bohrungen auf Maschinen mit Steigungsführung	Für gut spanbare Werkstoffe	Tiefes Sackloch $\leq 3 \times D$
<b>Spiralo 35 VAP</b>	Wie Spiralo 35, Oberflächenbehandlung Vaporisieren vermindert Kaltaufschweißungen	Unlegierte und niedriglegierte Stähle	Sackloch $\leq 2 \times D$
<b>Spiralo 35 VS</b>	Starke Rechtsspirale 30-40°, Anschnittlänge 2-3 Gang (Form C), Spanabfuhr in Schafrichtung, *für Temper-/Späroguss Oberfläche NIT verwenden	Stähle $800-1200 \text{ N/mm}^2$ , *Temperguss, *Spähroguss, CuAl-Legierung, langspanend	Sackloch $\leq 2 \times D$
<b>Spiralo 35 Z</b>	Starke Rechtsspirale 30-40°, Anschnittlänge 2-3 Gang (Form C), Spanabfuhr in Schafrichtung, verstärkter Freiwinkel	Für zähe, langspanende Werkstoffe	Sackloch $\leq 2 \times D$
<b>Spiralo 40 SYNC TiN</b>	Starke Rechtsspirale 35-45°, Anschnittlänge 2-3 Gang (Form C), Spanabfuhr in Schafrichtung, für die Bearbeitung von Sacklöchern in einem breiten Materialspektrum mit erhöhten Schnittgeschwindigkeiten, aus pulvermetallurgisch erzeugtem Schnellstahl hergestellt, Spanabfuhr in Schneidrichtung, mit Weldon Fläche, Schafttoleranz h6. Nur auf CNC Maschinen verwenden, Hartstoffbeschichtung TiN, siehe Seite T15	Langspanende Werkstoffe bis $1.100 \text{ N/mm}^2$	Sackloch
<b>Spiralo 45</b>	Sehr starke Rechtsspirale 45°, Anschnittlänge 2-3 Gang (Form C), Spanabfuhr in Schafrichtung, vergrößerter Spanraum	Langspanende Leichtmetalllegierungen	Sackloch
<b>Spiralo 48 TS TiN</b>	Sehr starke Rechtsspirale 45-48°, Anschnittlänge 2-3 Gang (Form C), Spanabfuhr in Schafrichtung, Hartstoffbeschichtung TiN, siehe Seite T15	Stähle bis $800 \text{ N/mm}^2$	Tiefes Sackloch $\leq 3 \times D$
<b>Spiralo 45 ZB TiN/Vap</b>	Sehr starke Rechtsspirale 45°- 48°, Anschnittlänge 2-3 Gang (Form C), Spanabfuhr in Schafrichtung, Hartstoffbeschichtung TiN, siehe Seite T15, aber Nuten/Spanflächen vaporisiert, für kontrollierte Spanabfuhr	Stähle bis $800 \text{ N/mm}^2$	Tiefes Sackloch $\leq 3 \times D$
<b>Standfest 0</b>	Ohne Nuten, mit Schälanschnitt, Anschnittlänge 4-5 Gang (Form B)	Für gut spanbare Werkstoffe	Durchgangsloch $\leq \frac{1}{2} \times D$
<b>Standfest 2</b>	2 gerade Schmiernuten mit Schälanschnitt, Anschnittlänge 4-5 Gang (Form B)	Für gut spanbare Werkstoffe	Durchgangsloch $\leq 1 \times D$
<b>Standfest 3</b>	3 oder mehr Schmiernuten mit Schälanschnitt, Anschnittlänge 4-5 Gang (Form B)	Für gut spanbare Werkstoffe	Durchgangsloch $\leq 1 \times D$
<b>Stufex 5</b>	Trapezgewindebohrer, flache Linksspiralnuten ca. 5°, mit Führungszapfen, Vorschneidstufe und unterteiltem Mantelschnitt	Für gut spanbare Werkstoffe	Durchgangsloch $\leq 2 \times D$
<b>2-Flach</b>	Anschnittlänge 1,5-2 Gang (Form E), speziell für tiefe Bohrungen	Messing kurzspanend	Sack- + Durchgangsloch

## Product-description HAHNREITER-Taps, in alphabetical order

Name	Type	Use	Type of core hole
<b>Automat</b>	Straight flutes, chamfer 2-3 threads (form C), for lathes. (only for Rd-thread)	Free-cutting-steels	Blind- and through holes
<b>Automat MS</b>	Straight flutes, chamfer 1,5-2 threads (form E), for automatic lathes	Short chipping brass	Blind- and through holes
<b>Automat 15</b>	R.H. spiral fluted 15°, chamfer 1,5-2 threads (form E), for automatic lathes, surface treatment VAP to prevent pick ups	Free-cutting-steels	Blind- and through holes
<b>Automat 20</b>	R.H. spiral fluted 20°, chamfer 1,5-2 threads (form E), for automatic lathes, surface treatment VAP to prevent pick ups	Free-cutting-steels	Blind holes
<b>Automat 20 MS-Z</b>	R.H. spiral fluted 20°, chamfer 1,5-2 threads (form E), for automatic lathes	Brass without or minor lead alloy	Blind holes
<b>Automat 20 STY</b>	R.H. spiral fluted 20°, chamfer 1,5-2 threads (form E), for automatic lathes, coating: STYGIAN, see page T15	Brass without or minor lead alloy, Special alloys	Blind holes
<b>Automat 20 TiN</b>	R.H. spiral fluted 20°, chamfer 1,5-2 threads (form E), for automatic lathes, coating: TiN, see page T15	Stainless steels	Blind holes
<b>Drückfix</b>	Cold forming tap to machine threads without chips, chamfer 2-3 threads (form C), remember to use different drill-Ø, use of coated tools is recommended	Materials with elongation of min. 10%	Blind holes, through holes < 1 x D
<b>Drückfix N</b>	Cold forming tap with oil grooves, to machine threads without chips, chamfer 2-3 threads (form C), remember to use different drill-Ø, use of coated tools is recommended	Materials with elongation of min. 10%	Blind- and through holes ≥ 1 x D
<b>Drückfix TiN</b>	See Drückfix, coating: TiN, see page T15	Materials with elongation of min. 10%	Blind holes, through holes < 1 x D
<b>Drückfix N TiN</b>	See Drückfix N, coating: TiN, see page T15	Materials with elongation of min. 10%	Blind- and through holes ≥ 1 x D
<b>Drückfix IKZ TiN</b>	Cold forming tap with oil grooves, to machine threads without chips, chamfer 2-3 threads (form C), remember to use different drill-Ø, axial internal coolant supply, coating: TiN, see page T15	Materials with elongation of min. 10%	Blind holes ≥ 1 x D
<b>Drückfix N CrB2</b>	Cold forming tap with oil grooves, to machine threads without chips, chamfer 2-3 threads (form C), remember to use different drill-Ø, coating: CrB2, see page T15	Aluminium and copper alloys with elongation of min. 7%	Blind- and through holes
<b>Drückfix N HF TiN</b>	Cold forming tap with oil grooves, to machine threads without chips, chamfer 2-3 threads (form C), remember to use different drill-Ø, powder-metallurgical steel, coating: TiN, see page T15	Materials with elongation of min. 10%	Blind- and through holes
<b>Drückfix N TiCN</b>	Cold forming tap with oil grooves, to machine threads without chips, chamfer 2-3 threads (form C), remember to use different drill-Ø, coating: TiCN, see page T15	Stainless steels with elongation of min. 10%	Blind- and through holes
<b>Dulofix</b>	Straight flutes with spiral point, chamfer 4-5 threads (form B), chips will be pushed in cutting direction	Universal tap for free machining materials	Through holes
<b>Dulofix AZ</b>	Straight flutes with spiral point, chamfer 4-5 threads (form B), chips will be pushed in cutting direction, adjusted geometry, with interrupted teeth	Soft and sticky materials	Through holes
<b>Dulofix HF</b>	Straight flutes with spiral point, chamfer 4-5 threads (form B), made from powder-metallurgical steel, chips will be pushed in cutting direction, coating is recommended	High-alloyed materials >1200 N/mm <sup>2</sup> tensile strength	Through holes
<b>Dulofix HF IKZ-R TiCN</b>	Straight flutes with spiral point, chamfer 4-5 threads (form B), made from powder-metallurgical steel, chips will be pushed in cutting direction, internal coolant supply, radial exit, improved cooling and chip evacuation, coating: TiCN, see page T15	High-alloyed materials >1200 N/mm <sup>2</sup> tensile strength	Through holes
<b>Dulofix HF TiCN</b>	See Dulofix HF, coating: TiCN, see page T15	High-alloyed materials >1200 N/mm <sup>2</sup> tensile strength	Through holes
<b>Dulofix Ni</b>	Straight flutes with spiral point, chamfer 5 threads (form B), made from powder-metallurgical steel, chips will be pushed in cutting direction, strong design	Tough nickel alloys, e.g. Nimonic, Inconel, Hastelloy	Through holes
<b>Dulofix SYNC TiN</b>	Straight flutes with spiral point, chamfer 4-5 threads (form B), chips will be pushed in cutting direction, suitable for a wide range of applications, increased cutting speed, shank tolerance h6 with Weldon flat, made from powder-metallurgical steel, should only be used on CNC machines, coating: TiN, see page T15	long chipping materials up to 1.100 N/mm <sup>2</sup> tensile strength	Through holes
<b>Dulofix Ti</b>	Straight flutes with spiral point, chamfer 5 threads (form B), made from powder-metallurgical steel, chips will be pushed in cutting direction, strong design	Titanium alloys	Through holes
<b>Dulofix TiCN</b>	See Dulofix, coating: TiCN, see page T15	Aluminium casting alloys >10% Si	Through holes
<b>Dulofix TiN</b>	See Dulofix, coating: TiN, see page T15	Universal tap for free machining materials	Through holes
<b>Dulofix VAP</b>	See type Dulofix, surface treatment VAP to prevent pick ups	Un- and low-alloyed steel	Through holes
<b>Dulofix VS</b>	Straight flutes with spiral point, chamfer 4-5 threads (form B), chips will be pushed in cutting direction *for malleable- and spheroidal cast iron nitriding is recommended	Steel 800-1200 N/mm <sup>2</sup> , malleable-* and spheroidal* cast iron, CuAl alloys	Through holes

## Product-description HAHNREITER-Taps, in alphabetical order

Name	Type	Use	Type of core hole
<b>Dulofix 15</b>	L.H. spiral fluted 15°, chamfer D 4-5 threads, chips will be pushed in cutting direction, for thin-walled components	Free machining materials	Through holes $\leq 1,5xD$
<b>Gussfix</b>	Straight flutes, chamfer 2-3 threads (form C), nitrided	Grey cast iron	Blind- and through holes
<b>Gussfix IKZ</b>	Straight flutes, chamfer 2-3 threads (form C), nitrided, with internal, axial coolant supply, improved chip-transport	Grey cast iron	Blind holes
<b>Gussfix TiN</b>	See Gussfix, coating: TiN, see page T15	Grey cast iron	Blind- and through holes
<b>Hahnreiter</b>	Straight flutes, chamfer 2-3 threads (form C), chips will remain in the flutes	Free machining materials	Short blind holes and through holes $\leq 1xD$
<b>Hahnreiter Ni AZ</b>	Straight flutes, chamfer 2-3 threads (form C), chips will remain in the flutes, Strong design with reinforced shank, powder-metallurgical steel, interrupted teeth, only available for NPT thread	Tough nickel alloys, e.g. Nimonic, Inconel, Hastelloy	Blind- and through holes
<b>Hahnreiter MS</b>	Straight flutes, chamfer 2-3 threads (form C), or chamfer 1,5-2 threads (form E)	Short chipping brass	Blind- and through holes
<b>Multifix</b>	Straight flutes with spiral point, chamfer 4-5 threads (form B), chips will be pushed in cutting direction, coating: STYGIAN, see page T15	Tool-steels	Through holes
<b>Multifix 35</b>	R.H. spiral fluted 35-40°, chamfer 2-3 threads (form C), chips are transported against cutting direction, coating: STYGIAN, see page T15	Tool-steels	Blind holes
<b>Nirofix</b>	Straight flutes with spiral point, chamfer 4-5 threads (form B), chips will be pushed in cutting direction, surface treatment VAP to prevent pick ups	Stainless steel	Through holes
<b>Nirofix 15</b>	R.H. spiral fluted 15°, chamfer 2-3 threads (form C), chips were slightly transported against cutting direction, Strong design with reinforced shank, powder-metallurgical steel, only available for NPT thread	Stainless steel	Blind- and through holes
<b>Nirofix 35</b>	R.H. spiral fluted 35-40°, chamfer 2-3 threads (form C), chips are transported against cutting direction, surface treatment VAP to prevent pick ups	Stainless steel	Blind holes
<b>Nirofix 35 TiN</b>	See Nirofix 35, coating: TiN, see page T15	Stainless steel	Blind holes
<b>Nirofix 35 TS</b>	See type Nirofix 35, but rear thread truncated to avoid breakage tapping should be done with pitch controlled feed	Stainless steel	Blind holes $\leq 3 \times D$
<b>Nirofix Z STY/WC</b>	Straight flutes with spiral point, chamfer 4-5 threads (form B), chips will be pushed in cutting direction, increased clearance angle, powder-metallurgical steel, multilayer coating: STYGIAN/WC, see page T15	Stainless steel, austenitic	Through holes
<b>Nirofix 48 STY/WC</b>	R.H. spiral fluted 45-50°, chamfer 2-3 threads (form C), chips are transported against cutting direction, increased clearance angle, powder-metallurgical steel, multilayer coating: STYGIAN/WC, see page T15, tapping should be done with pitch controlled feed	Stainless steel, austenitic	Blind holes $\leq 3 \times D$
<b>Nirofix AZ</b>	Similar to Nirofix, adjusted geometry, with interrupted teeth	Stainless steel, tough and sticky	Through holes
<b>Nirofix TiN</b>	See Nirofix, coating: TiN, see page T15	Stainless steel	Through holes
<b>Spiralo 15</b>	R.H. spiral fluted 15°, chamfer 2-3 threads (form C), chips were slightly transported against cutting direction, mainly to be used horizontally	Free machining materials	Blind holes $\leq 1xD$ horizontally $\leq 2 \times D$
<b>Spiralo 15 AZ</b>	Similar to Spiralo 15, adjusted geometry, with interrupted teeth, mainly to be used horizontally	Soft and sticky materials	Blind holes $\leq 1xD$ horizontally $\leq 2 \times D$
<b>Spiralo 15 HF TiCN</b>	R.H. spiral fluted 15°, chamfer 2-3 threads (form C), chips are transported against cutting direction, forms short chips when used in tool steel, high pressure cooling is needed to wash out chips, cutting speed 4-8 m/min. powder-metallurgical steel, coating: TiCN, see page T15	Tool steel High speed steel	Blind holes $\leq 3 \times D$
<b>Spiralo 15 HF IKZ TiCN</b>	See Spiralo 15 HF TiCN, internal coolant supply, improves forming of short chips	Tool steel High speed steel	Blind holes $\leq 3 \times D$
<b>Spiralo 15 IKZ</b>	R.H. spiral fluted 15°, chamfer 2-3 threads (form C), mainly for horizontal use, with internal axial coolant supply, better chip-transport against cutting direction, optimal coolant supply, coating is recommended	Universal for materials about 500-1200 N/mm <sup>2</sup> tensile strength	Blind holes $\leq 1xD$ , depending on character of chips $\leq 3xD$
<b>Spiralo 15 IKZ TiN</b>	see type Spiralo 15 IKZ, coating: TiN, see page T15, with internal, axial coolant supply, improved chip-transport against cutting direction	Universal for materials about 500-1200 N/mm <sup>2</sup> tensile strength	Blind holes $\leq 1xD$ , depending on character of chips up to 3xD
<b>Spiralo 15 Ti AZ</b>	R.H. spiral fluted 15°, chamfer 2-3 threads (form C), chips are transported against cutting direction, strong design, interrupted teeth, powder-metallurgical steel, nitrided	Titanium alloys	Blind holes
<b>Spiralo 15 TiCN</b>	see type Spiralo 15, coating: TiCN, see page T15	Aluminium casting alloys >10% Si	Blind holes $\leq 1 \times D$ horizontally $\leq 2 \times D$
<b>Spiralo 15 TiN</b>	see type Spiralo 15, coating: TiN, see page T15	Free machining materials	Blind holes $\leq 1xD$ horizontally $\leq 2 \times D$

## Product-description HAHNREITER-Taps, in alphabetical order

Name	Type	Use	Type of core hole
<b>Spiralo 25 Ni</b>	R.H. spiral fluted 25°, chamfer 2-3 threads (form C), chips are transported against cutting direction, made from powder-metallurgical steel, strong design	Tough nickel alloys, e.g. Nimonic, Inconel, Hastelloy	Blind holes
<b>Spiralo 25 Ti</b>	R.H. spiral fluted 25°, chamfer 2-3 threads (form C), chips are transported against cutting direction, made from powder-metallurgical steel, strong design, nitrided	Titanium alloys	Blind holes
<b>Spiralo 35</b>	R.H. spiral fluted 35-40°, chamfer 2-3 threads (form C), chips are transported against cutting direction	Universal tap for free machining materials	Blind holes $\leq 2xD$
<b>Spiralo 35 AZ</b>	Similar to Spiralo 35, adjusted geometry, with interrupted teeth	Soft and sticky materials	Blind holes $\leq 2xD$
<b>Spiralo 35 HF</b>	R.H. spiral fluted 35-40°, chamfer 2-3 threads (form C), made from powder-metallurgical steel, chips are transported against cutting direction coating is recommended	High-alloyed materials $>1200 \text{ N/mm}^2$ tensile strength	Blind holes
<b>Spiralo 35 HF TiCN</b>	see Spiralo 35 HF, coating: TiCN, see page T15	High-alloyed materials $>1200 \text{ N/mm}^2$ tensile strength	Blind holes
<b>Spiralo 35 IKZ</b>	R.H. spiral fluted 35-40°, chamfer 2-3 threads (form C), with internal, axial coolant supply, improved chip-transport against cutting direction, coating is recommended	Universal for materials about $500-1200 \text{ N/mm}^2$ tensile strength	Deep blind holes $\leq 3xD$
<b>Spiralo 35 IKZ TiN</b>	see type Spiralo 35 IKZ, , coating: TiN, see page T15, with internal, axial coolant supply, improved chip-transport against cutting direction	Universal for materials about $500-1200 \text{ N/mm}^2$ tensile strength	Deep blind holes $\leq 3xD$
<b>Spiralo 35 TiCN</b>	see Spiralo 35, coating: TiCN, see page T15	Aluminium casting alloys $>10\% \text{ Si}$	Blind holes $\leq 2xD$
<b>Spiralo 35 TiN</b>	see type Spiralo 35, coating: TiN, see page T15	Universal tap for free machining materials	Blind holes $\leq 2xD$
<b>Spiralo 35 TS</b>	see Spiralo 35, but rear thread truncated to avoid breakage, tapping should be done with pitch controlled feed	Free machining materials	Blind holes $\leq 3 \times D$
<b>Spiralo 35 VAP</b>	See Spiralo 35, surface treatment VAP to prevent pick ups	Un- and low-alloyed steels	Blind holes $\leq 2xD$
<b>Spiralo 35 VS</b>	R.H. spiral fluted 35-40°, chamfer 2-3 threads (form C), chips are transported against cutting direction *for malleable- and spheroidal cast iron nitriding is recommended	Steel $800-1200 \text{ N/mm}^2$ , *malleable and *spheroidal cast iron, CuAl alloys (long chipping)	Blind holes $\leq 2xD$
<b>Spiralo 35 Z</b>	R.H. spiral fluted 30-40°, chamfer 2-3 threads (form C), chips are transported against cutting direction, increased clearance angle	Tough long chipping materials	Blind holes $\leq 2xD$
<b>Spiralo 40 SYNC TiN</b>	R.H. spiral fluted 35-45°, chamfer 2-3 threads (form C), chips are transported against cutting direction, suitable for a wide range of applications, increased cutting speed, shank tolerance h6 with Weldon flat, made from powder-metallurgical steel, should only be used on CNC machines, coating: TiN, see page T15	long chipping materials up to $1.100 \text{ N/mm}^2$ tensile strength	Blind holes
<b>Spiralo 45</b>	R.H. spiral fluted 45°, chamfer 2-3 threads (form C), chips are transported against cutting direction	Soft and long chipping aluminium	Blind holes
<b>Spiralo 48 TS TiN</b>	R.H. spiral fluted 45-48°, chamfer 2-3 threads (form C), chips are transported against cutting direction, coating: TiN, see page T15	Stähle bis $800 \text{ N/mm}^2$	Deep blind holes $\leq 3xD$
<b>Spiralo 45 ZB TiN/Vap</b>	R.H. spiral fluted 45°, chamfer 2-3 threads (form C), chips are transported against cutting direction, coating: TiN, see page T15, cutting edges vaporized for improved chip control	Stähle bis $800 \text{ N/mm}^2$	Deep blind holes $\leq 3xD$
<b>Standfest 0</b>	Without flutes, only spiral point, chamfer 4-5 threads (form B)	Free machining materials	Through holes $\leq \frac{1}{2}xD$
<b>Standfest 2</b>	2 straight oil flutes, chamfer 4-5 threads (form B)	Free machining materials	Through holes $\leq 1xD$
<b>Standfest 3</b>	3 or more straight oil flutes, chamfer 4-5 threads (form B)	Free machining materials	Through holes $\leq 1xD$
<b>Stufex 5</b>	Trapezoidal tap, L.H. spiral flutes $\approx 5^\circ$ , with pilot, pre-cutting step and chip dividing profile steps	Free machining materials	Through holes $\leq 2xD$
<b>2-Flach</b>	2 flat flutes, chamfer E, 1-2 threads, specially for deep holes	Short chipping brass	Blind- and through holes



# Gewinde - Kernloch-Ø und Kern-Ø Muttergewinde

## Drill-Ø for Threads and Minor-Ø of Nut Threads

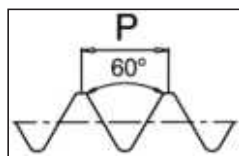
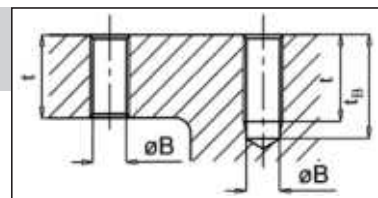

M Metr. ISO - Regelgewinde, 6H (5H) <sup>1)</sup> Metric ISO - Coarse Thread 6H (5H)					MF Metr. ISO - Feingewinde, 6H (4H) <sup>1)</sup> Metric ISO - Fine Thread 6H (4H)											
Ø	P [mm]	Kernloch Drill-Ø ØB	Muttergewinde Kern-Ø Nut Thread Minor-Ø		Ø	x	P [mm]	Kernloch Drill-Ø ØB	Muttergewinde Kern-Ø Nut Thread Minor-Ø		Ø	x	P [mm]	Kernloch Drill-Ø ØB	Muttergewinde Kern-Ø Nut Thread Minor-Ø	
			Min.	Max.					Min.	Max.					Min.	Max.
M 1	0,25	0,75	0,729	0,785	M 2	x	0,25	1,75	1,729	1,774	M 27	x	1,5	25,50	25,376	25,676
M 1,1	0,25	0,85	0,829	0,885	M 2,2	x	0,25	1,95	1,929	1,974	M 27	x	2	25,00	24,835	25,210
M 1,2	0,25	0,95	0,929	0,985	M 2,5	x	0,35	2,15	2,121	2,221	M 28	x	1,5	26,50	26,376	26,676
M 1,4	0,3	1,10	1,075	1,142	M 3	x	0,35	2,65	2,621	2,721	M 28	x	2	26,00	25,835	26,210
M 1,6	0,35	1,25	1,221	1,321	M 3,5	x	0,35	3,15	3,121	3,221	M 30	x	1	29,00	28,917	29,153
M 1,7*	0,35	1,30	1,256	1,346	M 4	x	0,35	3,65	3,621	3,721	M 30	x	1,5	28,50	28,376	28,676
M 1,8	0,35	1,45	1,421	1,521	M 4	x	0,5	3,50	3,459	3,599	M 30	x	2	28,00	27,835	28,210
M 2	0,4	1,60	1,567	1,679	M 5	x	0,5	4,50	4,459	4,599	M 32	x	1,5	30,50	30,376	30,676
M 2,2	0,45	1,75	1,713	1,838	M 6	x	0,5	5,50	5,459	5,599	M 32	x	2	30,00	29,835	30,210
M 2,3*	0,4	1,90	1,795	1,920	M 6	x	0,75	5,20	5,188	5,378	M 33	x	1,5	31,50	31,376	31,676
M 2,5	0,45	2,05	2,013	2,138	M 7	x	0,75	6,20	6,188	6,378	M 33	x	2	31,00	30,835	31,210
M 2,6*	0,45	2,10	2,036	2,176	M 8	x	0,5	7,50	7,459	7,599	M 34	x	1,5	32,50	32,376	32,676
M 3	0,5	2,50	2,459	2,599	M 8	x	0,75	7,20	7,188	7,378	M 35	x	1,5	33,50	33,376	33,676
M 3,5	0,6	2,90	2,850	3,010	M 8	x	1	7,00	6,917	7,153	M 36	x	1,5	34,50	34,376	34,676
M 4	0,7	3,30	3,242	3,422	M 9	x	0,75	8,20	8,188	8,378	M 36	x	2	34,00	33,835	34,210
M 4,5	0,75	3,70	3,688	3,878	M 9	x	1	8,00	7,917	8,153	M 36	x	3	33,00	32,752	33,252
M 5	0,8	4,20	4,134	4,334	M 10	x	0,5	9,50	9,459	9,599	M 38	x	1,5	36,50	36,376	36,676
M 6	1	5,00	4,917	5,153	M 10	x	0,75	9,20	9,188	9,378	M 39	x	1,5	37,50	37,376	37,676
M 7	1	6,00	5,917	6,153	M 10	x	1	9,00	8,917	9,153	M 39	x	2	37,00	36,835	37,210
M 8	1,25	6,80	6,647	6,912	M 10	x	1,25	8,80	8,647	8,912	M 39	x	3	36,00	35,752	36,252
M 9	1,25	7,80	7,647	7,912	M 11	x	1	10,00	9,917	10,153	M 40	x	1,5	38,50	38,376	38,676
M 10	1,5	8,50	8,376	8,676	M 12	x	0,5	11,50	11,459	11,599	M 40	x	2	38,00	37,835	38,210
M 11	1,5	9,50	9,376	9,676	M 12	x	0,75	11,20	11,188	11,378	M 40	x	3	37,00	36,752	37,252
M 12	1,75	10,20	10,106	10,441	M 12	x	1	11,00	10,917	11,153	M 42	x	1,5	40,50	40,376	40,676
M 14	2	12,00	11,835	12,210	M 12	x	1,25	10,80	10,647	10,912	M 42	x	2	40,00	39,835	40,210
M 16	2	14,00	13,835	14,210	M 12	x	1,5	10,50	10,376	10,676	M 42	x	3	39,00	38,752	39,252
M 18	2,5	15,50	15,294	15,744	M 13	x	1	12,00	11,917	12,153	M 45	x	1,5	43,50	43,376	43,676
M 20	2,5	17,50	17,294	17,744	M 14	x	1	13,00	12,917	13,153	M 45	x	2	43,00	42,835	43,210
M 22	2,5	19,50	19,294	19,744	M 14	x	1,25	12,80	12,647	12,912	M 45	x	3	42,00	41,752	42,252
M 24	3	21,00	20,752	21,252	M 14	x	1,5	12,50	12,376	12,676	M 48	x	1,5	46,50	46,376	46,676
M 27	3	24,00	23,752	24,252	M 15	x	1	14,00	13,917	14,153	M 48	x	2	46,00	45,835	46,210
M 30	3,5	26,50	26,211	26,771	M 15	x	1,5	13,50	13,376	13,676	M 48	x	3	45,00	44,752	45,252
M 33	3,5	29,50	29,211	29,771	M 16	x	1	15,00	14,917	15,153	M 50	x	1,5	48,50	48,376	48,676
M 36	4	32,00	31,670	32,270	M 16	x	1,5	14,50	14,376	14,676	M 50	x	2	48,00	47,835	48,210
M 39	4	35,00	34,670	35,270	M 18	x	1	17,00	16,917	17,153	M 50	x	3	47,00	46,752	47,252
M 42	4,5	37,50	37,129	37,799	M 18	x	1,5	16,50	16,376	16,676	M 52	x	1,5	50,50	50,376	50,676
M 45	4,5	40,50	40,129	40,799	M 18	x	2	16,00	15,835	16,210	M 52	x	2	50,00	49,835	50,210
M 48	5	43,00	42,587	43,297	M 20	x	1	19,00	18,917	19,153	M 52	x	3	49,00	48,752	49,252
M 52	5	47,00	46,587	47,297	M 20	x	1,5	18,50	18,376	18,676	M 54	x	1,5	52,50	52,376	52,676
M 56	5,5	50,50	50,046	50,796	M 20	x	2	18,00	17,835	18,210	M 56	x	1,5	54,50	54,376	54,676
M 60	5,5	54,50	54,046	54,796	M 22	x	1	21,00	20,917	21,153	M 56	x	2	54,00	53,835	54,210
M 64	6	58,00	57,505	58,305	M 22	x	1,5	20,50	20,376	20,676	M 56	x	3	53,00	52,752	53,252
M 68	6	62,00	61,505	62,305	M 22	x	2	20,00	19,835	20,210	M 58	x	1,5	56,50	56,376	56,676
					M 24	x	1	23,00	22,917	23,153	M 60	x	1,5	58,50	58,376	58,676
					M 24	x	1,5	22,50	22,376	22,676	M 60	x	2	58,00	57,835	58,210
					M 24	x	2	22,00	21,835	22,210	M 60	x	3	57,00	56,752	57,252
					M 25	x	1	24,00	23,917	24,153	M 64	x	2	62,00	61,835	62,210
					M 25	x	1,5	23,50	23,376	23,676	M 64	x	4	60,00	59,670	60,270
					M 26	x	1,5	24,50	24,376	24,676						

\* metrisches - DIN Profil / metric - DIN profile  
 1) Kernloch-Ø und Muttergewinde Kern-Ø gem. DIN 336, Toleranz 5H bis M 1,4, Toleranz 4H für Feingewinde mit Steigung P = 0,25  
 Drill-Ø and minor-Ø of nut thread according to DIN 336, tolerance 5H up to M 1,4, tolerance 4H for fine thread with pitch P = 0,25

# Gewinde - Kernloch-Ø und Kern-Ø Muttergewinde Drill-Ø for Threads and Minor-Ø of Nut Threads

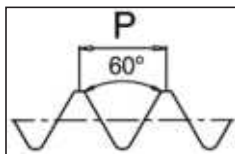
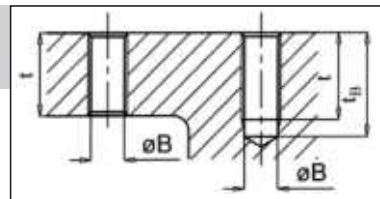

UNC Unified Grobgewinde <sup>1)</sup> Unified Coarse Thread						UNF Unified Feingewinde <sup>1)</sup> Unified Fine Thread						UNEF Unified Extra Feingewinde <sup>2)</sup> Unified Extra Fine Thread					
Ø"	Gg/1" TPI	Ø	Kernloch Drill-Ø ØB	Muttergewinde Kern-Ø Nut Thread Minor-Ø		Ø"	Gg/1" TPI	Ø	Kernloch Drill-Ø ØB	Muttergewinde Kern-Ø Nut Thread Minor-Ø		Ø"	Gg/1" TPI	Ø	Kernloch Drill-Ø ØB	Muttergewinde Kern-Ø Nut Thread Minor-Ø	
				Min.	Max.					Min.	Max.					Min.	Max.
Nr. 1	- 64	1,854	1,55	1,425	1,582	Nr. 1	- 72	1,854	1,55	1,473	1,613	Nr. 12	- 32	5,486	4,75	4,627	4,816
Nr. 2	- 56	2,184	1,85	1,694	1,872	Nr. 2	- 64	2,184	1,85	1,755	1,913	1/4	- 32	6,350	5,60	5,491	5,679
Nr. 3	- 48	2,515	2,10	1,941	2,146	Nr. 3	- 56	2,515	2,15	2,024	2,197	5/16	- 32	7,938	7,20	7,078	7,267
Nr. 4	- 40	2,845	2,35	2,156	2,385	Nr. 4	- 48	2,845	2,40	2,271	2,459	3/8	- 32	9,525	8,80	8,666	8,854
Nr. 5	- 40	3,175	2,65	2,487	2,697	Nr. 5	- 44	3,175	2,70	2,550	2,741	7/16	- 28	11,113	10,25	10,130	10,344
Nr. 6	- 32	3,505	2,85	2,642	2,896	Nr. 6	- 40	3,505	2,95	2,819	3,023	1/2	- 28	12,700	11,80	11,718	11,932
Nr. 8	- 32	4,166	3,50	3,302	3,531	Nr. 8	- 36	4,166	3,50	3,404	3,607	9/16	- 24	14,288	13,30	13,142	13,389
Nr. 10	- 24	4,826	3,90	3,683	3,962	Nr. 10	- 32	4,826	4,10	3,962	4,166	5/8	- 24	15,875	14,75	14,729	14,976
Nr. 12	- 24	5,486	4,50	4,343	4,597	Nr. 12	- 28	5,486	4,60	4,496	4,724	11/16	- 24	17,463	16,50	16,317	16,564
1/4	- 20	6,350	5,10	4,976	5,268	1/4	- 28	6,350	5,50	5,367	5,580	3/4	- 20	19,050	17,75	17,675	17,967
5/16	- 18	7,938	6,60	6,411	6,734	5/16	- 24	7,938	6,90	6,792	7,038	13/16	- 20	20,638	19,50	19,263	19,555
3/8	- 16	9,525	8,00	7,805	8,164	3/8	- 24	9,525	8,50	8,379	8,626	7/8	- 20	22,225	21,00	20,850	21,142
7/16	- 14	11,112	9,40	9,149	9,550	7/16	- 20	11,112	9,90	9,738	10,030	15/16	- 20	23,813	22,50	22,438	22,730
1/2	- 13	12,700	10,80	10,584	11,013	1/2	- 20	12,700	11,50	11,326	11,618	1	- 20	25,400	24,25	24,025	24,317
9/16	- 12	14,288	12,20	11,996	12,456	9/16	- 18	14,288	12,90	12,761	13,084	1.1/16	- 18	26,988	25,75	25,460	25,781
5/8	- 11	15,875	13,50	13,376	13,868	5/8	- 18	15,875	14,50	14,348	14,671	1.1/8	- 18	28,575	27,25	27,047	27,369
3/4	- 10	19,050	16,50	16,299	16,833	3/4	- 16	19,050	17,50	17,330	17,689	1.3/16	- 18	30,163	28,75	28,635	28,956
7/8	- 9	22,225	19,50	19,169	19,748	7/8	- 14	22,225	20,40	20,262	20,663	1.1/4	- 18	31,750	30,50	30,222	30,544
1	- 8	25,400	22,25	21,963	22,598	1	- 12	25,400	23,25	23,109	23,569	1.5/16	- 18	33,338	32,00	31,810	32,131
1.1/8	- 7	28,575	25,00	24,648	25,349	1.1/8	- 12	28,575	26,50	26,284	26,744	1.3/8	- 18	34,925	33,50	33,397	33,719
1.1/4	- 7	31,750	28,00	27,823	28,524	1.1/4	- 12	31,750	29,50	29,459	29,919	1.7/16	- 18	36,513	35,20	34,985	35,306
1.3/8	- 6	34,925	30,75	30,343	31,120	1.3/8	- 12	34,925	32,75	32,634	33,094	1.1/2	- 18	38,100	36,80	36,572	36,894
1.1/2	- 6	38,100	34,00	33,518	34,295	1.1/2	- 12	38,100	36,00	35,809	36,269	1.9/16	- 18	39,688	38,40	38,160	38,481
1.3/4	- 5	44,450	39,50	38,951	39,814							1.5/8	- 18	41,275	40,00	39,747	40,069
2	- 4.5	50,800	45,00	44,689	45,598							1.11/16	- 18	42,863	41,50	41,335	41,656

1) Kernloch-Ø und Muttergewinde Kern-Ø gem. DIN 336  
Drill-Ø and minor-Ø of nut thread according to DIN 336

2) Mutterkern-Ø gem. ANSI B1.1 (D<sub>1</sub>min = D<sub>1</sub> Nennmaß)  
Minor-Ø of nut thread accord. to ANSI B1.1

## UN - 8 - Gang Gewindereihe<sup>3)</sup> Unified Thread - 8 TPI

Ø"	Gg/1" TPI	Ø	Kernloch Drill-Ø ØB	Muttergewinde Kern-Ø Nut Thread Minor-Ø		Ø"	Gg/1" TPI	Ø	Kernloch Drill-Ø ØB	Muttergewinde Kern-Ø Nut Thread Minor-Ø		Ø"	Gg/1" TPI	Ø	Kernloch Drill-Ø ØB	Muttergewinde Kern-Ø Nut Thread Minor-Ø	
				Min.	Max.					Min.	Max.					Min.	Max.
1.1/8	- 8	28,575	25,50	25,138	25,773	1.1/2	- 8	38,100	35,00	34,663	35,298	1.7/8	- 8	47,625	44,50	44,188	44,823
1.1/4	- 8	31,750	28,75	28,313	28,948	1.5/8	- 8	41,275	38,00	37,838	38,473	2	- 8	50,800	47,75	47,363	47,998
1.3/8	- 8	34,925	31,75	31,488	32,123	1.3/4	- 8	44,450	41,50	41,013	41,648						

3) Mutterkern-Ø gem. ANSI B1.1 (D<sub>1</sub>min = D<sub>1</sub> Nennmaß) / Minor-Ø of nut thread accord. to ANSI B1.1

## Zylindrische Amerikanische Rohrgewinde Cylindrical American Pipe Threads

Ø"	Gg/1" TPI	Allgemeine Anwendung / general purpose				Trockendichtende Gewinde / Dryseal				
		NPSC <sup>4)</sup>		NPSM <sup>4)</sup>		NPSF <sup>5)</sup>		NPSI <sup>5)</sup>		
		Kern-Ø Minor-Ø Min.	Kernloch Drill-Ø ØB	Kern-Ø Minor-Ø Min.	Kernloch Drill-Ø ØB	Kern-Ø Minor-Ø Min.	Kernloch Drill-Ø ØB	Kern-Ø Minor-Ø Min.	Kernloch Drill-Ø ØB	
1/8	27	8,687	8,80	9,093	9,246	9,10	8,651	8,70	8,710	8,75
1/4	18	11,176	11,40	11,887	12,217	12,00	11,232	11,30	11,321	11,40
3/8	18	14,656	14,80	15,316	15,545	15,50	14,671	14,70	14,760	14,85
1/2	14	18,161	18,50	18,974	19,279	19,00	18,118	18,20	18,237	18,30
3/4	14	23,495	23,80	24,333	24,638	24,50	23,465	23,50	23,579	23,70
1	11,5	29,489	29,90	30,505	30,759	30,50	29,464	29,50	29,604	29,70
1.1/4	11,5	38,252	38,60	39,268	39,497	39,40				
1.1/2	11,5	44,323	44,70	45,339	45,568	45,50				
2	11,5	56,363	56,70	57,379	57,607	57,50				

4) Mutterkern-Ø gem. ANSI B1.20.1 / Minor-Ø of nut thread accord. to ANSI B1.20.1

5) Mutterkern-Ø gem. ANSI B1.20.3 / Minor-Ø of nut thread accord. to ANSI B1.20.3

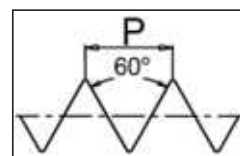



# Gewinde - Kernloch-Ø und Kern-Ø Muttergewinde

## Drill-Ø for Threads and Minor-Ø of Nut Threads

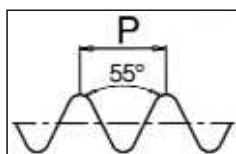
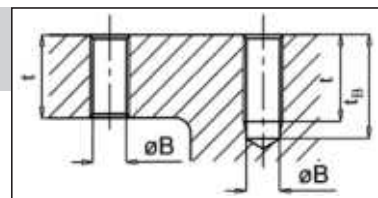

BSW Whitworth Grobgewinde <sup>1)</sup> Whitworth Coarse Thread					BSF Whitworth Feingewinde <sup>1)</sup> Whitworth Fine Thread					BA British-Association <sup>2)</sup>							
Ø" - Gg/1"	Ø	Kernloch Drill-Ø	Muttergewinde Kern-Ø Nut Thread Minor-Ø		Ø"	Gg/1"	Ø	Kernloch Drill-Ø	Muttergewinde Kern-Ø Nut Thread Minor-Ø		Ø" - P [mm]	Ø	Kernloch Drill-Ø	Muttergewinde Kern-Ø Nut Thread Minor-Ø			
			Min.	Max.					Min.	Max.				Min.	Max.		
1/16	60	1,588	1,20	1,045	1,232	3/16	32	4,763	3,90	3,747	4,006	BA 10	0,35	1,70	1,35	1,280	1,410
3/32	48	2,381	1,90	1,704	1,911	7/32	28	5,556	4,60	4,394	4,676	BA 9	0,39	1,90	1,50	1,430	1,575
1/8	40	3,175	2,50	2,362	2,591	1/4	26	6,350	5,30	5,100	5,398	BA 8	0,43	2,20	1,80	1,680	1,840
5/32	32	3,969	3,20	2,952	3,213	9/32	26	7,144	6,10	5,893	6,190	BA 7	0,48	2,50	2,00	1,920	2,100
3/16	24	4,763	3,60	3,406	3,744	5/16	22	7,938	6,80	6,459	6,817	BA 6	0,53	2,80	2,30	2,160	2,360
1/4	20	6,350	5,10	4,724	5,156	3/8	20	9,525	8,30	7,899	8,331	BA 5	0,59	3,20	2,60	2,490	2,710
5/16	18	7,938	6,50	6,129	6,589	7/16	18	11,113	9,70	9,304	9,764	BA 4	0,66	3,60	3,00	2,810	3,060
3/8	16	9,525	7,90	7,493	7,988	1/2	16	12,700	11,10	10,668	11,163	BA 3	0,73	4,10	3,40	3,220	3,495
7/16	14	11,113	9,30	8,791	9,332	9/16	16	14,288	12,70	12,256	12,751	BA 2	0,81	4,70	4,00	3,730	4,035
1/2	12	12,700	10,50	9,987	10,589	5/8	14	15,875	14,00	13,553	14,094	BA 1	0,90	5,30	4,50	4,220	4,560
9/16	12	14,288	12,00	11,575	12,177	11/16	14	17,463	15,50	15,141	15,682	BA 0	1,00	6,00	5,10	4,800	5,175
5/8	11	15,875	13,50	12,918	13,559	3/4	12	19,050	16,75	16,337	16,939						
11/16	11	17,463	15,00	14,506	15,146	7/8	11	22,225	19,75	19,268	19,909						
3/4	10	19,050	16,40	15,799	16,485	1	10	25,400	22,75	22,149	22,835						
7/8	9	22,225	19,25	18,613	19,355	1.1/8	9	28,575	25,50	24,963	25,705						
1	8	25,400	22,00	21,336	22,149	1.1/4	9	31,750	28,75	28,138	28,880						
1.1/8	7	28,575	24,75	23,927	24,831	1.3/8	8	34,925	31,50	30,861	31,674						
1.1/4	7	31,750	27,75	27,102	28,006	1.1/2	8	38,100	34,80	34,036	34,849						
1.3/8	6	34,925	30,50	29,504	30,528												
1.1/2	6	38,100	33,50	32,680	33,703												
1.5/8	5	41,275	35,50	34,769	35,963												
1.3/4	5	44,450	39,00	37,943	39,136												
2	4.5	50,800	44,50	43,571	44,877												

1) Mutterkern-Ø gem. BS 84  
Minor-Ø of nut accord. to BS 84

2) Mutterkern-Ø gem. BS 93  
Minor-Ø of nut accord. to BS 93

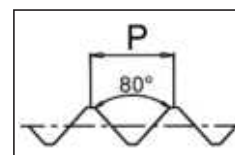
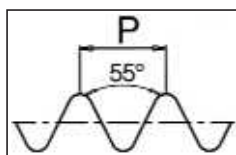

G Whitworth Rohrgewinde <sup>3)</sup> Whitworth Pipe Thread					Rp Whitworth Rohrgewinde <sup>3)</sup> Whitworth Pipe Thread					PG Stahlpanzerrohr-Gewinde <sup>4)</sup> Steel Conduit Thread							
Ø" - Gg/1"	Ø	Kernloch Drill-Ø	Muttergewinde Kern-Ø Nut Thread Minor-Ø		Ø"	Gg/1"	Ø	Kernloch Drill-Ø	Muttergewinde Kern-Ø Nut Thread Minor-Ø		Ø" - Gg/1"	Ø	Kernloch Drill-Ø	Muttergewinde Kern-Ø Nut Thread Minor-Ø			
			Min.	Max.					Min.	Max.				Min.	Max.		
G 1/16	28	7,723	6,80	6,516	6,843	Rp 1/16	28	7,723	6,55	6,490	6,632	Pg 7	20	12,50	11,35	11,28	11,43
G 1/8	28	9,728	8,80	8,566	8,848	Rp 1/8	28	9,728	8,60	8,495	8,637	Pg 9	18	15,20	13,95	13,86	14,01
G 1/4	19	13,157	11,80	11,445	11,890	Rp 1/4	19	13,157	11,50	11,341	11,549	Pg 11	18	18,60	17,35	17,26	17,41
G 3/8	19	16,662	15,25	14,950	15,395	Rp 3/8	19	16,662	15,00	14,846	15,054	Pg 13,5	18	20,40	19,15	19,06	19,21
G 1/2	14	20,955	19,00	18,631	19,172	Rp 1/2	14	20,955	18,50	18,489	18,773	Pg 16	18	22,50	21,25	21,16	21,31
G 5/8	14	22,911	21,00	20,587	21,128							Pg 21	16	28,30	26,90	26,78	27,03
G 3/4	14	26,441	24,50	24,117	24,658	Rp 3/4	14	26,441	24,00	23,975	24,259	Pg 29	16	37,00	35,60	35,48	35,73
G 7/8	14	30,201	28,25	27,877	28,418							Pg 36	16	47,00	45,60	45,48	45,73
G 1	11	33,249	30,75	30,291	30,931	Rp 1	11	33,249	30,25	30,111	30,471	Pg 42	16	54,00	52,60	52,48	52,73
G 1.1/8	11	37,897	35,50	34,939	35,579							Pg 48	16	59,30	57,90	57,78	58,03
G 1.1/4	11	41,910	39,50	38,952	39,592	Rp 1.1/4	11	41,910	39,00	38,772	39,132						
G 1.3/8	11	44,320	42,00	41,365	42,005												
G 1.1/2	11	47,803	45,25	44,845	45,485	Rp 1.1/2	11	47,803	45,00	44,665	45,025						
G 1.3/4	11	53,746	51,10	50,788	51,428												
G 2	11	59,614	57,00	56,656	57,296	Rp 2	11	59,614	56,50	56,476	56,836						
G 2.1/4	11	65,710	63,10	62,752	63,392												
G 2.1/2	11	75,184	72,50	72,226	72,866	Rp 2.1/2	11	75,184	72,25	72,083	72,443						
G 2.3/4	11	81,534	79,00	78,576	79,216												
G 3	11	87,884	85,50	84,926	85,566	Rp 3	11	87,884	85,00	84,783	85,143						
G 3.1/2	11	100,330	98,00	97,372	98,012												
G 4	11	113,030	110,50	110,072	110,712	Rp 4	11	113,030	110,00	109,860	110,289						

3) Kernloch-Ø und Muttergewinde Kern-Ø gem. DIN 336  
Drill-Ø and minor-Ø of nut thread according to DIN 336

4) Mutterkern-Ø gem. DIN 40430  
Minor-Ø of nut thread accord. to DIN 40430

Kernloch-Ø / Drill-Ø

# Gewinde - Kernloch-Ø und Kern-Ø Muttergewinde Drill-Ø for Threads and Minor-Ø of Nut Threads

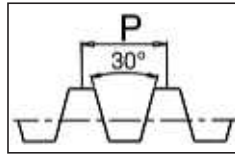
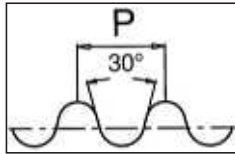
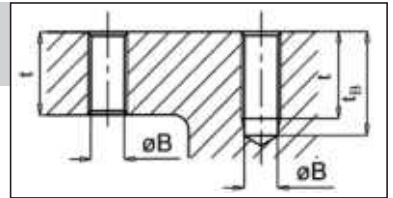

Rd Rundgewinde <sup>1)</sup> Round Thread					Tr Metrisches ISO-Trapezgewinde <sup>2)</sup> Metric ISO Trapezoidal Thread											
Ø	- Gg/1" TPI	Kernloch Drill-Ø ØB	Muttergewinde Kern-Ø Nut Thread Minor-Ø		Ø	x	P [mm]	Kernloch Drill-Ø ØB	Muttergewinde Kern-Ø Nut Thread Minor-Ø		Ø	x	P [mm]	Kernloch Drill-Ø ØB	Muttergewinde Kern-Ø Nut Thread Minor-Ø	
			Min.	Max.					Min.	Max.					Min.	Max.
Rd 8 x 1/10	8,254	6,00	5,714	6,274	Tr 8 x 1,5		6,60	6,500	6,690	Tr 20 x 2		18,20	18,000	18,236		
Rd 9 x 1/10	9,254	7,00	6,714	7,274	Tr 8 x 2		6,20	6,000	6,236	Tr 20 x 4		16,25	16,000	16,375		
Rd 10 x 1/10	10,254	8,00	7,714	8,274	Tr 9 x 1,5		7,60	7,500	7,690	Tr 22 x 3		19,25	19,000	19,315		
Rd 11 x 1/10	11,254	9,00	8,714	9,274	Tr 9 x 2		7,20	7,000	7,236	Tr 22 x 5		17,25	17,000	17,450		
Rd 12 x 1/10	12,254	10,00	9,714	10,274	Tr 10 x 1,5		8,60	8,500	8,690	Tr 24 x 3		21,25	21,000	21,315		
Rd 14 x 1/8	14,318	11,50	11,142	11,812	Tr 10 x 2		8,20	8,000	8,236	Tr 24 x 5		19,25	19,000	19,450		
Rd 16 x 1/8	16,318	13,50	13,142	13,812	Tr 10 x 3 <sup>3)</sup>		7,50			Tr 26 x 3		23,25	23,000	23,315		
Rd 18 x 1/8	18,318	15,50	15,142	15,812	Tr 11 x 2		9,20	9,000	9,236	Tr 26 x 5		21,25	21,000	21,450		
Rd 20 x 1/8	20,318	17,50	17,142	17,812	Tr 11 x 3		8,25	8,000	8,315	Tr 28 x 3		25,25	25,000	25,315		
Rd 22 x 1/8	22,318	19,50	19,142	19,812	Tr 12 x 2		10,20	10,000	10,236	Tr 28 x 5		23,25	23,000	23,450		
Rd 24 x 1/8	24,318	21,50	21,142	21,812	Tr 12 x 3		9,25	9,000	9,315	Tr 30 x 3		27,25	27,000	27,315		
Rd 26 x 1/8	26,318	23,50	23,142	23,812	Tr 14 x 2		12,20	12,000	12,236	Tr 30 x 6		24,25	24,000	24,500		
Rd 28 x 1/8	28,317	25,50	25,142	25,812	Tr 14 x 3		11,25	11,000	11,315	Tr 32 x 6		26,25	26,000	26,500		
Rd 30 x 1/8	30,318	27,50	27,142	27,812	Tr 14 x 4 <sup>3)</sup>		10,50			Tr 36 x 6		30,25	30,000	30,500		
Rd 32 x 1/8	32,318	29,50	29,142	29,812	Tr 16 x 2		14,20	14,000	14,236	Tr 40 x 7		33,50	33,000	33,560		
					Tr 16 x 4		12,25	12,000	12,375	Tr 42 x 7		35,50	35,000	35,560		
					Tr 18 x 2		16,20	16,000	16,236	Tr 44 x 7		37,50	37,000	37,560		
					Tr 18 x 4		14,25	14,000	14,375							

1) Mutterkern-Ø gem. DIN 405  
Minor-Ø of nut thread accord. to DIN 405

2) Mutterkern-Ø gem. DIN 103 / Minor-Ø of nut thread accord. to DIN 103

3) Tr 10 x 3 und Tr 14 x 4 in DIN 103 nicht mehr enthalten und sollten für Neukonstruktionen nicht mehr verwendet werden. / Tr 10 x 3 and Tr 14 x 4 not included in DIN 103, should not be used for new design.

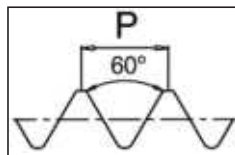

EGM Metrisches Einsatz-Gewinde - für Gewindeeinsätze aus Draht <sup>4)</sup> Metric Insert Thread - for Wire Inserts																			
Ø	P [mm]	Außen-Ø Out-side-Ø Min.	Kernloch Drill-Ø ØB	Muttergewinde Kern-Ø Nut Thread Minor-Ø		Ø	x	P [mm]	Außen-Ø Out-side-Ø Min.	Kernloch Drill-Ø ØB	Muttergewinde Kern-Ø Nut Thread Minor-Ø		Ø	x	P [mm]	Außen-Ø Out-side-Ø Min.	Kernloch Drill-Ø ØB	Muttergewinde Kern-Ø Nut Thread Minor-Ø	
				Min.	Max.						Min.	Max.						Min.	Max.
EG M 2	0,4	2,520	2,10	2,087	2,177	EG M 8 x 1		9,300	8,30	8,217	8,407	EG M 30 x 2		32,598	30,50	30,433	30,733		
EG M 2,5	0,45	3,084	2,65	2,597	2,697	EG M 9 x 1		10,300	9,30	9,217	9,407	EG M 30 x 3		33,897	31,00	30,649	31,049		
EG M 3	0,5	3,650	3,15	3,108	3,220	EG M 10 x 1		11,300	10,30	10,217	10,407	EG M 33 x 2		35,598	33,50	33,433	33,733		
EG M 3,5	0,6	4,280	3,70	3,630	3,755	EG M 10 x 1,25		11,624	10,40	10,271	10,483	EG M 33 x 3		36,897	34,00	33,649	34,049		
EG M 4	0,7	4,910	4,20	4,152	4,292	EG M 11 x 1		12,300	11,30	11,217	11,407	EG M 36 x 2		38,598	36,50	36,433	36,733		
EG M 5	0,8	6,040	5,25	5,174	5,334	EG M 12 x 1		13,300	12,30	12,217	12,407	EG M 36 x 3		39,897	37,00	36,649	37,049		
EG M 6	1	7,300	6,30	6,217	6,407	EG M 12 x 1,25		13,624	12,40	12,271	12,483	EG M 39 x 2		41,598	39,50	39,433	39,733		
EG M 7	1	8,300	7,30	7,217	7,407	EG M 12 x 1,5		13,948	12,50	12,324	12,560	EG M 39 x 3		42,897	40,00	39,649	40,049		
EG M 8	1,25	9,624	8,40	8,271	8,483	EG M 14 x 1		15,300	14,30	14,217	14,407	EG M 42 x 2		44,598	42,50	42,433	42,733		
EG M 10	1,5	11,948	10,50	10,324	10,560	EG M 14 x 1,25		15,624	14,40	14,271	14,483	EG M 42 x 3		45,897	43,00	42,649	43,049		
EG M 12	1,75	14,274	12,50	12,379	12,644	EG M 14 x 1,5		15,948	14,50	14,324	14,560	EG M 42 x 4		47,196	43,00	42,866	43,311		
EG M 14	2	16,598	14,50	14,433	14,733	EG M 15 x 1,5		16,948	15,50	15,324	15,560	EG M 45 x 2		47,598	45,50	45,433	45,733		
EG M 16	2	18,598	16,50	16,433	16,733	EG M 16 x 1,5		17,948	16,50	16,324	16,560	EG M 45 x 3		48,897	46,00	45,649	46,049		
EG M 18	2,5	21,248	18,75	18,541	18,896	EG M 18 x 1,5		19,948	18,50	18,324	18,560	EG M 48 x 2		50,598	48,50	48,433	48,733		
EG M 20	2,5	23,248	20,75	20,541	20,896	EG M 18 x 2		20,598	18,50	18,433	18,733	EG M 48 x 3		51,897	49,00	48,649	49,049		
EG M 22	2,5	25,248	22,75	22,541	22,896	EG M 20 x 1,5		21,948	20,50	20,234	20,560								
EG M 24	3	27,897	24,75	24,649	25,049	EG M 20 x 2		22,598	20,50	20,433	20,733								
EG M 27	3	30,897	27,75	27,649	28,049	EG M 22 x 1,5		23,948	22,50	22,234	22,560								
EG M 30	3,5	34,546	31,00	30,757	31,207	EG M 22 x 2		24,598	22,50	22,433	22,733								
EG M 33	3,5	37,546	34,00	33,757	34,207	EG M 24 x 1,5		25,948	24,50	24,324	24,560								
EG M 36	4	41,196	37,00	36,866	37,341	EG M 24 x 2		26,598	24,50	24,433	24,733								
EG M 39	4	44,196	40,00	39,866	40,431	EG M 26 x 1,5		27,948	26,50	26,324	26,560								
EG M 42	4,5	47,846	43,25	42,975	43,505	EG M 27 x 1,5		28,948	27,50	27,324	27,560								
EG M 45	4,5	50,846	46,25	45,975	46,505	EG M 27 x 2		29,598	27,50	27,433	27,733								
EG M 48	5	54,495	49,50	49,082	49,642	EG M 28 x 1,5		29,948	28,50	28,324	28,560								
EG M 52	5	58,495	53,50	53,082	53,642	EG M 30 x 1,5		31,948	30,50	30,324	30,560								

4) Maße des Muttergewindes gem. DIN 8140 Teil 2 / Sizes of nut thread accord. to DIN 8140 part 2

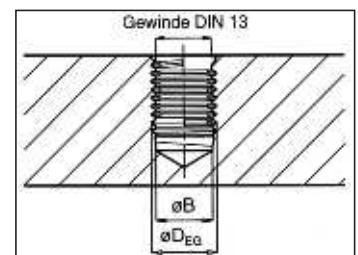

Kernloch-Ø / Drill-Ø

# Gewinde - Kernloch-Ø für konische Rohrgewinde

## Drill-Ø for Taper Pipe Threads

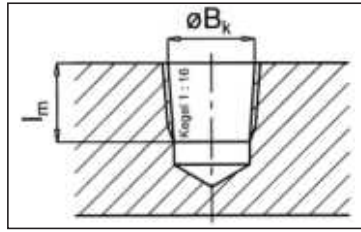
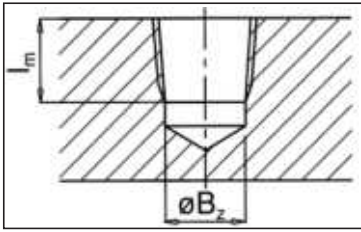

NPT amerikanisches kegeliges Rohrgewinde <sup>1)</sup> American Taper Pipe Thread					NPTF amerikanisches kegeliges Rohrgewinde American Taper Pipe Thread						
Ø"	Gg/1" TPI	Ø (Lm)	Kernloch Drill-Ø		Ø"	Gg/1" TPI	Ø (Lm)	Kernloch Drill-Ø			
			zyl. Bz cyl. Bz	kon. BK taper BK				zyl. Bz cyl. Bz	kon. BK taper BK		
NPT 1/16	27	7,84	9,20	6,20	6,39	NPTF 1/16	27	7,84	9,20	6,20	6,42
NPT 1/8	27	10,18	9,30	8,50	8,74	NPTF 1/8	27	10,18	9,30	8,50	8,76
NPT 1/4	18	13,54	13,50	11,10	11,36	NPTF 1/4	18	13,54	13,50	11,00	11,40
NPT 3/8	18	16,98	13,90	14,55	14,80	NPTF 3/8	18	16,98	13,90	14,50	14,84
NPT 1/2	14	21,14	18,10	18,00	18,32	NPTF 1/2	14	21,14	18,10	17,80	18,33
NPT 3/4	14	26,49	18,60	23,25	23,67	NPTF 3/4	14	26,49	18,60	23,10	23,68
NPT 1	11,5	33,14	22,30	29,20	29,69	NPTF 1	11,5	33,14	22,30	29,10	29,72
NPT 1.1/4	11,5	41,90	22,80	37,95	38,45	NPTF 1.1/4	11,5	41,90	22,80	37,80	38,48
NPT 1.1/2	11,5	47,97	22,80	44,00	44,52	NPTF 1.1/2	11,5	47,97	22,80	43,90	44,55
NPT 2	11,5	60,00	22,80	56,00	56,56	NPTF 2	11,5	60,00	22,80	55,90	56,59

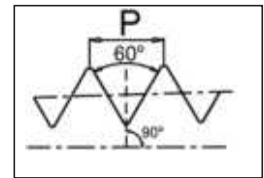

- Für Serienfertigung empfehlen wir die Kernlöcher konisch vorzuarbeiten (BK)  
For mass production preparation of a taper core hole is recommended.
- Die Messlänge L<sub>m</sub> von HAHNREITER Standard Gewindebohrern umfasst die Einschraubängen L<sub>1</sub> (Verschraubung von Hand) und L<sub>3</sub> (Kraftverschraubung) nach ANSI B1.20.1 und ANSI B1.20.3 sowie eine Anschnittlänge von 2-3 Gewindegängen. Bei Sacklöchern muss zur Sicherheit min. 1-2 Gewindegänge tiefer gebohrt werden.  
Gauge length L<sub>m</sub> of HAHNREITER standard taps covers L<sub>1</sub> (screwing by hand) and L<sub>3</sub> (screwing by means of wrenching tools) accord. to ANSI B1.20.1 and ANSI B1.20.3 and chamfer length of 2-3 threads. Blind holes have to be machined 1-2 threads deeper for safety.

Rc kegeliges Whitworth-Rohrgewinde Kegel 1:16, gem. ISO 7/1 und BS 21 taper Whitworth Pipe-Thread, Taper 1:16, accord. to ISO 7/1 and BS 21					
	Gg/1" TPI	Ø-Nominal (Lm)	Messebene Gewindebohrer Gauge plane of tap L <sub>m</sub>	Kernloch / Drill-Ø	
			zylindrisch cylindrical Bz	konisch taper <sup>3)</sup> BK	
Rc 1/8	28	9,728	10,10	8,2	8,57
Rc 1/4	19	13,157	15,00	11,0	11,45
Rc 3/8	19	16,662	15,40	14,5	14,95
Rc 1/2	14	20,955	20,40	18,0	18,63
Rc 3/4	14	26,441	21,70	23,4	24,12
Rc 1	11	33,249	26,00	29,5	30,29
Rc 1.1/4	11	41,910	28,30	38,0	38,95
Rc 1.1/2	11	47,803	28,30	43,9	44,85
Rc 2	11	59,614	32,60	55,5	56,66
Rc 2.1/2	11	75,184	37,10	70,9	72,23
Rc 3	11	87,884	40,20	83,4	84,93
Rc 4	11	113,030	46,20	108,2	110,07

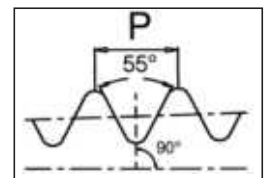

- Für Serienfertigung empfehlen wir die Kernlöcher konisch vorzuarbeiten (BK)  
For mass production preparation of a taper core hole is recommended.

W zylindrisches Whitworth Gewinde DIN 477 / Cylindrical Whitworth Thread according to DIN 477				
	P Gg/1" / TPI	Kern-Ø / Core-Ø Min. <sup>4)</sup>	Mutter / Nut Thread	Kernloch / Drill-Ø ØB
			Minor-Ø Max.	
W 21,8 x 1/14	14	19,496	20,066	19,75
W 24,32 x 1/14	14	22,016	22,586	22,25
W 1 x 1/8	8	21,339	22,152	22,00

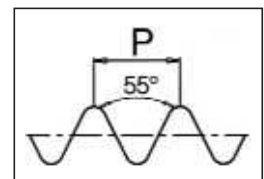

W kegeliges Whitworth Gewinde DIN 477 / Taper Whitworth Thread according to DIN 477				
	P Gg/1" / TPI	Messebene Gewindebohrer Gauge plane of tap L <sub>m</sub>	Kernloch / Drill-Ø	
		zylindrisch cylindrical Max.	konisch taper <sup>5)</sup> ØB	
W 19,8 x 1/14 keg.	14	24,2	14,7	16,8
W 28,8 x 1/14 keg.	14	29,2	22,7	25,4
W 31,3 x 1/14 keg.	14	29,2	25,2	27,9

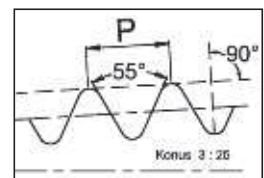

- Mutterkern-Ø gem. DIN 477 Teil 1 / Minor-Ø of nut thread accord. to DIN 477 part 1
- Für Serienfertigung empfehlen wir die Kernlöcher konisch vorzuarbeiten (BK)  
For mass production preparation of a taper core hole is recommended.

# Vorbohr-Ø Gewindeformer Drill-Ø for Cold Forming Taps

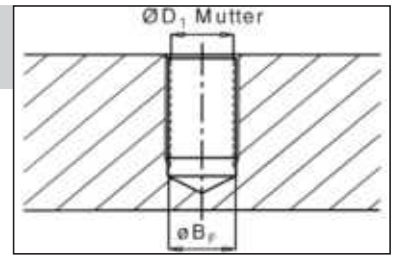
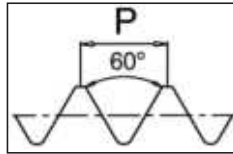

<b>M</b> Metrisches ISO - Regelgewinde, 6HX <i>Metric ISO - Coarse Thread 6HX</i>				<b>MF</b> Metrisches ISO - Feingewinde, 6HX <i>Metric ISO - Fine Thread 6HX</i>					
Ø	P [mm]	Vorbohr-Ø Drill-Ø B <sub>F</sub>	Muttergewinde Kern-Ø <sup>1)</sup> Nut Thread Minor - Ø <sup>1)</sup> 7H		Ø	P [mm]	Vorbohr-Ø Drill-Ø B <sub>F</sub>	Muttergewinde Kern-Ø <sup>1)</sup> Nut Thread Minor - Ø <sup>1)</sup> 7H	
			Min.	Max.				Min.	Max.
M 1	0,25	0,90	0,729	0,785	M 6 x	0,75	5,65	5,188	5,424
M 1,2	0,25	1,10	0,929	0,985	M 8 x	0,75	7,65	7,188	7,424
M 1,4	0,3	1,25	1,075	1,142	M 8 x	1	7,55	6,917	7,217
M 1,6	0,35	1,45	1,221	1,321	M 10 x	1	9,55	8,917	9,217
M 1,7	0,35	1,55	1,256	1,346	M 10 x	1,25	9,40	8,647	8,982
M 1,8	0,35	1,65	1,421	1,521	M 12 x	1	11,55	10,917	11,217
M 2	0,4	1,85	1,567	1,679	M 12 x	1,25	11,40	10,647	10,982
M 2,5	0,45	2,30	2,013	2,138	M 12 x	1,5	11,30	10,376	10,751
M 3	0,5	2,80	2,459	2,639	M 14 x	1,5	13,30	12,376	12,751
M 3,5	0,6	3,25	2,850	3,050	M 16 x	1,5	15,30	14,376	14,751
M 4	0,7	3,70	3,242	3,466	M 18 x	1,5	17,30	16,376	16,751
M 5	0,8	4,65	4,134	4,384	M 20 x	1,5	19,30	18,376	18,751
M 6	1	5,55	4,917	5,217					
M 8	1,25	7,40	6,647	6,982					
M 10	1,5	9,30	8,376	8,751					
M 12	1,75	11,20	10,106	10,531					
M 14	2	13,10	11,835	12,310					
M 16	2	15,10	13,835	14,310					
M 18	2,5	16,90	15,294	15,854					
M 20	2,5	18,90	17,294	17,854					
M 22	2,5	20,90	19,294	19,854					
M 24	3	22,70	20,752	21,382					
M 27	3	25,70	23,752	24,382					
M 30	3,5	28,50	26,211	26,921					
M 33	3,5	31,50	29,211	29,921					
M 36	4	34,30	31,670	32,420					
M 39	4	37,30	34,670	35,420					

1) Ab M 3 - empfohlene Toleranzfeldkombination für gefurchte Gewinde 6H 7H (D<sub>2</sub>, D<sub>1</sub>) vgl. DIN 13 Teil 50  
Over M 3 - recommended combination of tolerances for threads being produced by cold forming taps 6H / 7H see DIN 13 Teil 50

<b>UNC</b> Unified Grobgewinde ANSI B 1.1 <i>Unified Coarse Threads ANSI B 1.1</i>				<b>UNF</b> Unified Feingewinde ANSI B 1.1 <i>Unified Fine Threads ANSI B 1.1</i>					
Ø	P [Gg/1"]	Vorbohr-Ø Drill-Ø B <sub>F</sub>	Muttergewinde Kern-Ø <sup>1)</sup> Nut Thread Minor - Ø <sup>1)</sup> 2B		Ø	P [Gg/1"]	Vorbohr-Ø Drill-Ø B <sub>F</sub>	Muttergewinde Kern-Ø <sup>1)</sup> Nut Thread Minor - Ø <sup>1)</sup> 2B	
			Min.	Max.				Min.	Max.
Nr. 4 -	40	2,55	2,156	2,385	Nr. 4 -	48	2,60	2,271	2,459
Nr. 5 -	40	2,90	2,487	2,697	Nr. 5 -	44	2,90	2,550	2,741
Nr. 6 -	32	3,15	2,642	2,896	Nr. 6 -	40	3,20	2,819	3,023
Nr. 8 -	32	3,80	3,302	3,531	Nr. 8 -	36	3,85	3,404	3,607
Nr. 10 -	24	4,35	3,683	3,962	Nr. 10 -	32	4,45	3,962	4,166
Nr. 12 -	24	5,00	4,343	4,597	Nr. 12 -	28	5,10	4,496	4,724
1/4 -	20	5,75	4,976	5,268	1/4 -	28	5,95	5,367	5,580
5/16 -	18	7,30	6,411	6,734	5/16 -	24	7,45	6,792	7,038
3/8 -	16	8,80	7,805	8,164	3/8 -	24	9,05	8,379	8,626
7/16 -	14	10,30	9,149	9,550	7/16 -	20	10,55	9,738	10,030
1/2 -	13	11,80	10,584	11,013	1/2 -	20	12,10	11,326	11,618
9/16 -	12	13,30	11,996	12,456	9/16 -	18	13,65	12,761	13,084
5/8 -	11	14,80	13,376	13,868	5/8 -	18	15,25	14,348	14,671
3/4 -	10	17,90	16,299	16,833	3/4 -	16	18,35	17,330	17,689

<b>G</b> Whitworth Rohrgewinde DIN ISO 228 <i>Whitworth Pipe Threads. DIN ISO 228</i>				
Ø	P [Gg/1"]	Vorbohr-Ø Drill-Ø B <sub>F</sub>	Muttergewinde Kern-Ø <sup>1)</sup> Nut Thread Minor - Ø <sup>1)</sup>	
			Min.	Max.
G 1/8 -	28	9,30	8,566	8,848
G 1/4 -	19	12,50	11,445	11,890
G 3/8 -	19	16,00	14,950	15,395
G 1/2 -	14	20,00	18,631	19,172
G 3/4 -	14	25,50	24,117	24,658

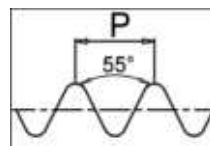



**Gewinde - Kernloch-Ø und Kern-Ø Muttergewinde**  
**Drill-Ø for Threads and Minor-Ø of Nut Threads**

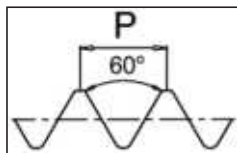
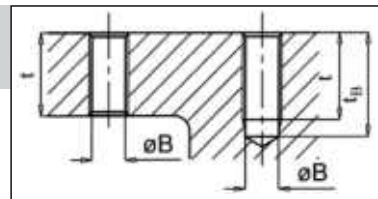

EG-UNC						EG-UNF							
Unified Grobgewinde für Draht-Gewindeeinsätze						Unified Feingewinde für Draht-Gewindeeinsätze							
Unified Coarse Threads for wire inserts						Unified Fine Threads for wire inserts							
Ø	-	Gg/1" TPI	Außen Ø	Kernloch	Muttergewinde Kern-Ø		Ø	-	Gg/1" TPI	Außen Ø	Kernloch	Muttergewinde Kern-Ø	
			Outside Ø	Drill-Ø	Nut Thread Minor-Ø					Outside Ø	Drill-Ø	Nut Thread Minor-Ø	
			Min 2B/3B	ØB	Min. 2B/3B	Max. 3B				Min 2B/3B	ØB	Min. 2B/3B	Max. 3B
EG Nr. 2	-	56	2,774	2,35	2,283	2,441	EG Nr. 4	-	48	3,533	3,00	2,962	3,122
EG Nr. 3	-	48	3,203	2,70	2,631	2,804	EG Nr. 6	-	40	4,331	3,70	3,645	3,818
EG Nr. 4	-	40	3,670	3,10	2,985	3,180	EG Nr. 8	-	36	5,083	4,40	4,321	4,498
EG Nr. 5	-	40	4,001	3,40	3,315	3,487	EG Nr. 10	-	32	5,857	5,10	4,999	5,184
EG Nr. 6	-	32	4,536	3,80	3,678	3,879	EG 1/4	-	28	7,529	6,60	6,546	6,721
EG Nr. 8	-	32	5,197	4,40	4,338	4,524	EG 5/16	-	24	9,312	8,25	8,166	8,352
EG Nr. 10	-	24	6,200	5,20	5,055	5,283	EG 3/8	-	24	10,899	9,80	9,754	9,931
EG Nr. 12	-	24	6,861	5,80	5,715	5,944	EG 7/16	-	20	12,764	11,50	11,387	11,585
EG 1/4	-	20	8,001	6,70	6,624	6,868	EG 1/2	-	20	14,351	13,10	12,974	13,172
EG 5/16	-	18	9,771	8,40	8,242	8,489	EG 9/16	-	18	16,121	14,70	14,592	14,798
EG 3/8	-	16	11,587	10,00	9,868	10,127	EG 5/8	-	18	17,709	16,30	16,180	16,386
EG 7/16	-	14	13,470	11,70	11,506	11,783	EG 3/4	-	16	21,112	19,50	19,393	19,609
EG 1/2	-	13	15,237	13,30	13,122	13,393	EG 7/8	-	14	24,582	22,75	22,619	22,845
EG 9/16	-	12	17,038	14,90	14,747	15,032	EG 1	-	12	28,151	26,00	25,860	26,114
EG 5/8	-	11	18,875	16,50	16,375	16,673							
EG 3/4	-	10	22,349	19,75	19,599	19,909							
EG 7/8	-	9	25,890	23,00	22,835	23,162							
EG 1	-	8	29,525	26,20	26,088	26,469							

1) Kernloch-Ø und Muttergewinde Kern-Ø gem. NASM 33537  
 Drill-Ø and minor-Ø of nut thread according to NASM 33537

# HAHNREITER Beschichtungen / Coatings

	TiN	TiCN	Stygian (Multifix)	STY(WC)	CrB2	NiT	VAP
Mikrohärte, (HV 0,05)	2.300	3.000	3.300	3.300	5.000	1.000	-
Max. Einsatz-Temperatur, °C	600°	400°	900°	900°	500°	-	-
Reibwert gegen Stahl / Friction	0,4	0,4	0,35	0,2	< 0,15	0,5	-

- TiN** PVD Hartstoffschicht Titan-Nitrid, Farbe: Gold.  
Für Gewindebohrer hervorragend geeignete universelle Verschleißschicht Schichtdicke ca 3µ. Sehr verschleißfest, vermindert Reibung und Aufschweißungen. Erlaubt höhere Schnittgeschwindigkeiten. Serienmäßig bei Type "TiN".
- TiCN** PVD Hartstoffschicht Titan-Carbonitrid, Farbe: Blau/Grau.  
Härter als TiN. Hervorragende Verschleißfestigkeit aber geringere Temperaturbeständigkeit als TiN. Geeignet für hochlegierte und harte Stähle sowie Aluminiumgusslegierungen mit hohen Siliziumanteilen. Serienmäßig bei Type "TiCN".
- STYGIAN** PVD Hartstoffschicht, Monolayer, eine moderne Weiterentwicklung der TiAlN Schicht, Farbe: Braun/Violett  
Vereint die Verschleißfestigkeit von Titan-Carbonitrid und die gute Temperaturbeständigkeit von Titan-Aluminiumnitrid. Hervorragende Temperaturbeständigkeit und Zähigkeit. Auch geeignet für Trockenschnitt und hohe Schnittgeschwindigkeiten. Serienmäßig bei Type "Multifix".
- STY/WC** Stygian Basis Schicht mit zusätzlicher Gleit-Schmierschicht, Farbe: Dunkelgrau.  
Sehr gute Gleiteigenschaften durch geringen Reibwert gegen Stahl. Hoher Widerstand gegen Abrasiv-Verschleiß, geringe Neigung zu Aufschweißungen. Serienmäßig bei Type "Nirofix Z" und "Nirofix 48".
- CrB2** DLC Hartstoff-Dünnschicht aus tetraedrisch amorphem Kohlenstoff, Farbe: Schwarz-Violett.  
Hohe Härte und geringer Reibwert. Hervorragend geeignet zur Bearbeitung von Aluminium-, Kupfer-, Messing- und Bronzelegierungen. Wegen geringer Schichtdicke und geringer Beschichtungstemperatur auch für Lehren geeignet. Serienmäßig bei Type „Drückfix N CrB2“.
- Nit** Oberflächenbehandlung Nitrieren, Farbe: Schwarz/Grau.  
Stickstoffanreicherung in der Oberfläche durch Salzbadverfahren. Preiswerter Verschleißschutz. Geeignet zur Bearbeitung von metallischen Gusswerkstoffen. Serienmäßig bei Type "Gussfix".
- VAP** Oberflächenbehandlung Vaporisieren, Farbe: Blau/Schwarz.  
Aufdampfen einer nichtmetallischen Oxydschicht. Wirkt als Trennschicht und vermindert Kaltaufschweißungen bei der Stahlbearbeitung. Serienmäßig bei Typen "VAP" und "Nirofix".
- 
- TiN** *PVD Hard-coating of Titanium-nitride, colour: gold.  
Universal coat for taps. Thickness about 3 µ. Excellent wear resistance. Decreased friction. Against cold weldings. Allows higher cutting speeds. Standard for type "TiN".*
- TiCN** *PVD Hard-coating of Titanium-carbonitride, colour: blue/violet.  
Harder than TiN. Excellent wear resistance, but lower temperature-resistance. Some advantages in hard materials. Useful for high alloyed and hard materials as well as aluminium castings with high contents of silicon. Standard for type "TiCN".*
- STYGIAN** *PVD Mono-layer hard coating, a modern development of the TiAlN coating, colour: brown-violet. Combination of the wear resistance of TiCN and the high temperature-resistance of TiAlN. Excellent oxidizing resistance and toughness. Suitable also for dry cutting and high cutting speeds. Standard for type "Multifix".*
- STY/WC** *Stygian basic coat plus additional slide-coating, colour: dark-grey.  
Very good sliding characteristics against steel. High resistance against contact-wear. and pick-ups. Standard for type „Nirofix Z" and "Nirofix 48".*
- CrB2** *DLC thin Hard-coating of amorphous carbon. Colour: black-violet.  
High hardness, very low friction. Most Suitable to work aluminium-, copper- brass- and bronze-alloys due to it's composition. Because of thin coating thickness and low coating temperature also useful for gauges. Standard for type „Drückfix N CrB2“.*
- Nit** *Surface treatment Nitriding, colour: black/grey.  
Case hardens the surface of the tool by saltbath treatment. Low cost wear resistance. Suitable for ferrous castings. Standard for type "Gussfix".*
- VAP** *Surface treatment Vaporisation, colour: blue/black.  
Steam tempering process. The non-ferrous oxide film reduces pick ups when machining steels with low carbon content. Standard for type "VAP" and "Nirofix".*



# Begriffe und Bezeichnungen an Gewindebohrern Terms on Taps

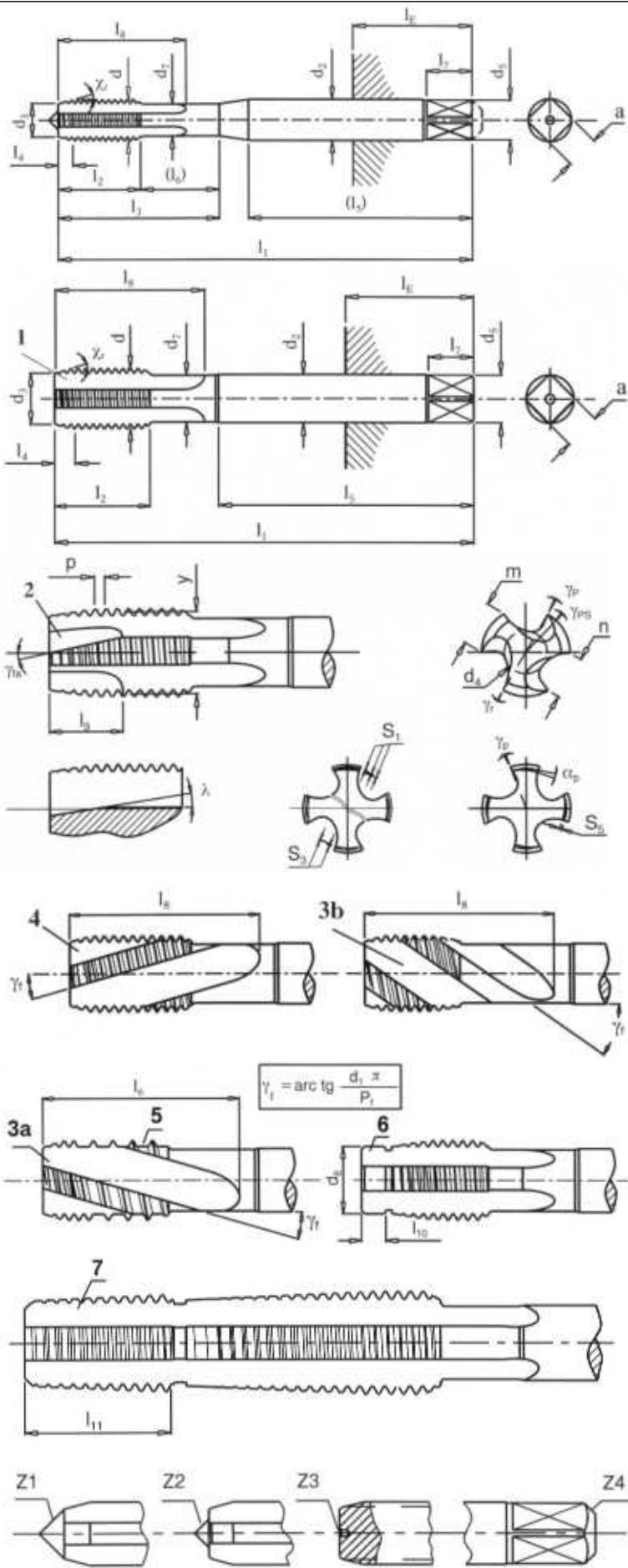

a	Schlüsselfläche Vierkant	size across flats of square
d	Gewinde Nenn-Ø	nominal-Ø of thread
d <sub>2</sub>	Schaft-Ø	shank-Ø
d <sub>3</sub>	Anschnitt-Ø	chamfer-Ø
d <sub>4</sub>	Seelen-Ø Nute	core-Ø of flute
d <sub>5</sub>	Vierkantfreidrehung	undercut for square
d <sub>7</sub>	Hals-Ø	neck-Ø
d <sub>8</sub>	Führungszapfen-Ø	plain cylindrical pilot
l <sub>1</sub>	Gesamtlänge	total length
l <sub>2</sub>	Gewindelänge	thread length
l <sub>3</sub>	Nutzlänge	useful length
l <sub>4</sub>	Anschnittlänge	chamfer length
l <sub>5</sub>	Schaftlänge	length of shank
l <sub>6</sub>	Halslänge	length of neck
l <sub>7</sub>	Vierkantlänge	length of square
l <sub>8</sub>	Nutenlänge	length of flute
l <sub>9</sub>	Schälanschnittlänge	length of spiral point
l <sub>10</sub>	Länge Führungszapfen	length of cylindrical pilot
l <sub>11</sub>	Länge Vorschneidstufe	length of cutting step
l <sub>E</sub>	Einspannlänge	reception length
m	Stegbreite	width of land
N	Anzahl Spannuten	number of flutes
n	Nutenbreite	width of flute
p	Gewindesteigung	pitch
P <sub>f</sub>	Spiralsteigung	pitch of helix
S <sub>1</sub>	Hinterschliff des gesamten Gewindeprofils auf Stegbreite gemessen	thread relief (on major-Ø, thread flanks and minor-Ø)
S <sub>3</sub>	Hinterschliff nur auf Flanke und Kern, auf Stegbreite gemessen	thread relief (on thread flanks and minor-Ø only)
S <sub>5</sub>	Anschnittinterschliff (bezogen auf Stegbreite)	radial relief of chamfer (on width of land)
y	Konus im Gewinde	cone in thread
Z <sub>1</sub>	Vollspitze	external centre
Z <sub>2</sub>	abgesetzte Spitze	external centre with reduced point
Z <sub>3</sub>	Zentrierbohrung	internal centre
Z <sub>4</sub>	Zentrierfase	centring chamfer
α <sub>p</sub>	Anschnittfreiwinkel	chamfer relief angle
χ <sub>r</sub>	Anschnittwinkel	chamfer angle
γ <sub>f</sub>	Spiralwinkel	angle of helical flute
γ <sub>fA</sub>	Schälanschnittwinkel horizontal	spiral point angle (horizontal)
γ <sub>p</sub>	Spanwinkel	rake angle
γ <sub>ps</sub>	Spanwinkel Schälanschnitt (Messpunkt: l <sub>4</sub> ÷ 2)	rake angle of spiral point (measuring point: l <sub>4</sub> ÷ 2)
γ <sub>r</sub>	Rückenwinkel	back angle
λ	Schälanschnittwinkel vertikal	spiral point angle (vertical)
1	gerade Nuten	straight flutes
2	Schälanschnitt	spiral point
3a	Rechtsspiralnuten (≈ 15°)	helical flute RH (≈ 15°)
3b	Rechtsspiralnuten (≈ 35°)	helical flute RH (≈ 35°)
4	Linksspiralnuten (≈ 15°)	helical flute LH (≈ 15°)
5	ausgesetzte Zähne	interrupted teeth
6	Führungszapfen	cylindrical pilot
7	Vorschneidstufe	cutting step

# Begriffe und Bezeichnungen an Gewindebohrern Terms on Taps

	<p>Gewindeformer ohne Schmiernuten</p> <p>Gewindeformer mit Schmiernuten</p>	<p>d Gewinde Nenn-Ø <i>nominal-Ø of thread</i></p> <p>d<sub>3</sub> Einlaufkegel-Ø <i>chamfer-Ø</i></p> <p>l<sub>5</sub> Länge Einlaufkegel <i>length of chamfer</i></p> <p>K Anzahl Polygone <i>number of polygons</i></p> <p>N Anzahl Schmiernuten <i>number of oil grooves</i></p>
	<p>Gewindeprofil Gewindebohrer</p>	<p>p Steigung <i>pitch</i></p> <p>α Flankenwinkel <i>included angle of thread</i></p> <p>α/2 Teilflankenwinkel <i>1/2 included angle of thread</i></p> <p>R Radius Gewindekern <i>radius at minor-Ø of thread</i></p> <p>d Außen-Ø <i>major-Ø</i></p> <p>d<sub>2</sub> Flanken-Ø <i>pitch-Ø</i></p> <p>d<sub>1</sub> Kern-Ø <i>minor-Ø</i></p> <p>B<sub>k</sub> Breite Gewindekern <i>width of core of thread</i></p> <p>Steigungswinkel / lead angle = <math>\arctan^{-1}(p / (d_2 \cdot \pi))</math></p>

## Anschnittformen an Gewindebohrern / Chamfer Forms on Taps

	Anschnittform DIN 2197 / chamfer form Winkel / angle ≈	Anzahl Gewindegänge / number of threads	Nutenform / shape of flutes	Anwendung überwiegend für / main application for
	<b>A</b> 5°	<b>6 - 8</b>	gerade genutet / straight flutes	flache Durchgangsbohrung short through holes
	<b>B</b> 8°	<b>3,5 - 5,5</b>	gerade genutet mit Schälanschnitt / straight flutes with spiral point	Durchgangsbohrungen in mittel bis lang spanenden Werkstoffen / through holes being cut in medium to long chipping material
	<b>C</b> 15°	<b>2 - 3</b>	gerade oder spiral- genutet / straight or helical flutes	Sacklöcher und auch für Durch- gangslöcher bei kurz spanenden Werkstoffen / blind holes and through holes in short chipping materials
	<b>D</b> 8°	<b>3,5 - 5,5</b>	gerade oder spiral- genutet / straight or helical flutes	Sacklöcher mit langem Gewindeauslauf sowie Durchgangslöcher / blind holes with long thread run out or through holes
	<b>E</b> 23°	<b>1,5 - 2</b>	gerade oder spiral- genutet / straight or helical flutes	Sacklöcher mit kurzem Gewindeauslauf / blind holes with short thread run-out
	<b>F</b> 35°	<b>1</b>	gerade oder spiral- genutet / straight or helical flutes	Sacklöcher mit sehr kurzem Gewindeauslauf / blind holes with extremely short thread run-out

### Berechnung anderer Anschnittwinkel:

$$\tan \chi_c = \frac{\text{Außen-Ø } (d_A) - \text{Anschnitt-Ø } (d_3)}{\text{Anschnittlänge } (l_5) \cdot 2}$$

Der Anschnitt-Ø muss unter dem Mindestmaß des Gewindekern-Ø des zu schneidenden Muttergewindes liegen. Bei nicht in den Baumaßnormen festgelegten Anschnitt-Ø empfehlen wir die Anwendung folgender Formel:

$$\text{Anschnitt-Ø } (d_3) \text{ (Tol. h13)} = D_1 \text{ (min.)} - 0,05 \cdot P$$

D<sub>1</sub> = Min. Kern-Ø Muttergewinde  
d<sub>A</sub> = Außen-Ø des Gewindebohrers

### Calculation of other chamfer angles

$$\tan \chi_c = \frac{\text{Outside-Ø } (d_A) - \text{Chamfer-Ø } (d_3)}{\text{Length of Chamfer } (l_5) \cdot 2}$$

Chamfer-Ø always has to be produced below min. value of minor diameter of the thread that is to be produced. For those applications where the design standards do not specify the chamfer-Ø we recommend the following formula:

$$\text{chamfer-Ø } (d_3) \text{ (Tol. h13)} = D_1 \text{ (min.)} - 0,05 \cdot P$$

D<sub>1</sub> = Min. minor-Ø of thread  
d<sub>A</sub> = outside-Ø of tap

# Toleranzen am Gewindeteil von Gewindebohrern für metrisches ISO Gewinde

## Tolerances on the Thread of Taps for Metric ISO-Thread

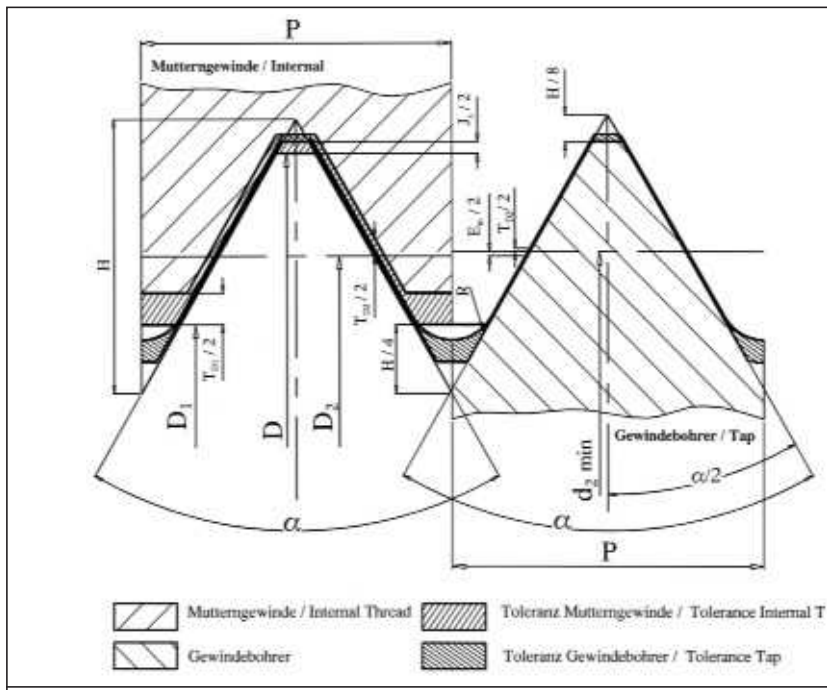

Muttergewinde / Internal Thread	
H	Höhe des Spitzprofils / height of sharp thread profile
D	Nenn-Außen-Ø / basic outside-Ø
D <sub>1</sub>	Nenn-Kern-Ø / basic minor-Ø
D <sub>2</sub>	Nenn-Flanken-Ø / basic effective-Ø
P	Gewindesteigung / pitch
T <sub>D1</sub>	Toleranz des Kern-Ø / tolerance of minor-Ø
T <sub>D2</sub>	Toleranz des Flanken-Ø / tolerance of effective-Ø
EI	Grundabmaß / fundamental deviation
α	Flankenwinkel (60°) / included angle of thread (60°)
Gewindebohrer / Taps	
d	Nenn-Außen-Ø (d = D) / basic outside-Ø (d=D)
d <sub>2</sub>	Flanken-Ø Gewindebohrer / effective-Ø of tap
E <sub>m</sub>	Unteres Grenzabmaß für d <sub>2</sub> / lower deviation for d <sub>2</sub>
T <sub>d2</sub>	Toleranz des Flanken-Ø / tolerance of effective-Ø
t = T <sub>D2(Qual5)</sub>	Tol. Klasse 5 des Muttergew. / tol. class 5 of internal thread
Js	unteres Abmaß des Außen-Ø / lower deviation of outside-Ø
P	Gewindesteigung / pitch
α	Flankenwinkel (60°) / thread flank angle (60°)
α/2	Teilflankenwinkel (30°) / 1/2 included angle of thread (30°)
R	H/6 = 0,14434·P Nennradius / nom. Radius

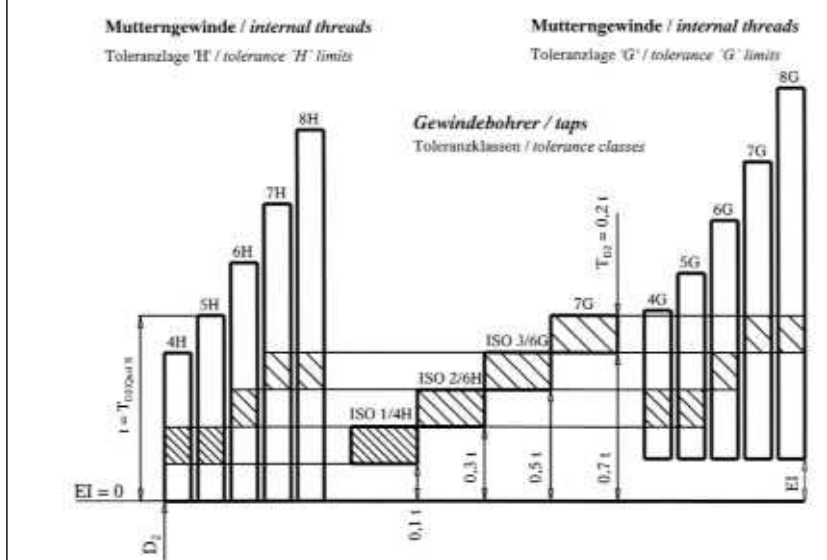

Der Flanken-Ø bei metrischen Gewinden wird berechnet als / effective-Ø of Metric thread is calculated as	$D_2 = d_2 = D - 0,64952 \cdot P$
Toleranzen und Grundabmaße von Flanken- und Außen-Ø des Gewindebohrers für metrische Gewinde werden ausgehend von der Toleranzeinheit „t“ berechnet / tolerances and fundamental deviations of major- and effective-Ø are calculated based on tolerance unit „t“	$t = T_{D2(Qual5)}$ (vgl. Tab. 5 ISO 965-1) $T_{D2(Qual5)} = 90 \cdot P^{0,4} \cdot d^{0,1} \cdot 1,06$ <small>(d = geometrischen Mittel der Durchmesser / d = geometric mean of diameters)</small>

Toleranzklasse / tolerance class	Flanken-Ø Min. und Max. effective-Ø Min. and Max.	Außen-Ø / major-Ø (DIN 802/1 (zurückgezogen / withdrawn))
ISO 1 / 4H	$d_{2min} = d_2 + 0,1 \cdot t$ $d_{2max} = d_2 + 0,3 \cdot t$	$d_{min.} = D + 0,3 \cdot t$
ISO 2 / 6H	$d_{2min} = d_2 + 0,3 \cdot t$ $d_{2max} = d_2 + 0,5 \cdot t$	$d_{min.} = D + 0,5 \cdot t$
ISO 3 / 6G	$d_{2min} = d_2 + 0,5 \cdot t$ $d_{2max} = d_2 + 0,7 \cdot t$	$d_{min.} = D + 0,7 \cdot t$
7G (DIN 802/4)	$d_{2min} = d_2 + 0,7 \cdot t$ $d_{2max} = d_2 + 0,9 \cdot t$	$d_{min.} = D + 0,9 \cdot t$

Toleranzen



## Toleranzen am Gewindeteil von Gewindebohrern für metrisches ISO Gewinde Tolerances on the Thread of Taps for Metric ISO-Thread

Toleranzklasse Gewindebohrer <sup>1)</sup> / tolerance class of tap <sup>1)</sup>		Toleranzfeld des zu fertigenden Muttergewindes / tolerance field of internal thread to be cut					Bemerkungen / remarks	Technische Anwendung / Technical application
DIN 802 <sup>1)</sup>	DIN-EN22857							
4H (DIN 802 / 1) <sup>2)</sup>	ISO 1	4H	5H				Untermaß / undersize	Gewindeverbindungen mit wenig Spiel / Thread with small clearance
6H (DIN 802 / 1) <sup>2)</sup>	ISO 2	4G	5G	6H			Normal / normal	Normale Gewindeverbindung / Thread with normal clearance
6G (DIN 802 / 1) <sup>2)</sup>	ISO 3			6G	7H	8H	Aufmaß / oversize	Gewindeverbindungen mit viel Spiel / Thread with large clearance
7G (DIN 802 / 4) <sup>1)</sup>					7G	8G	Aufmaß / oversize	vorbeugend für Verzug durch Wärmebehandlung / Allowance for distortion caused by heat treatment
6H +0,1 <sup>3)</sup>							Aufmaß / oversize	galvan. Oberflächenbeh. mit Schichtdicke ≈ 25µm / Electroplating allowance ≈ 25µm thickness
6H +0,2 <sup>3)</sup>							Aufmaß / oversize	galvan. Oberflächenbeh. mit Schichtdicke ≈ 50µm / Electroplating allowance ≈ 50µm thickness

- 1) Die Gewindemaße der Gewindebohrer für metrische Gewinde sind in DIN-EN 22857 festgelegt. Da in der Praxis die Bezeichnungen gem. DIN 802 Teil 1 (zurückgezogen) noch sehr gebräuchlich sind, werden unsere Gewindebohrer mit beiden Toleranzangaben beschriftet. Die Toleranzklasse 7G ist in DIN EN 22857 nicht enthalten und wird in DIN 802 Teil 4 festgelegt. Die erhöhten X-Toleranzlagen sind nicht genormt und werden nach Werksnorm gefertigt. Durch diese Maßerhöhung soll der Deformation bei der Bearbeitung oder dem Verschleiß bei der Zerspanung abrasiver Werkstoffe begegnet werden. Das Aufmaß hat keinen Einfluss auf die Toleranz des zu schneidenden Muttergewindes. /  
Thread dimensions of taps are specified in DIN-EN 22857. However the terms given in DIN 802 part 1 (withdrawn) are more common therefore our taps will be marked with both tolerance terms. Tolerance class 7G is not specified in DIN-EN 22857 but is given in DIN 802 part 4. The increased X-tolerances are non standard and will be produced according to manufacturer's standard. This oversize is an allowance to compensate shrinkage or wear when machining abrasive materials. It doesn't affect tolerance of internal thread.
- 2) DIN 802/1 zurückgezogen / DIN 802/1 standard withdrawn
- 3) Die Erhöhung des Flanken-Ø (A) durch galvanische Überzüge (Schichtstärke T) hängt vom Flankenwinkel (α) ab. Das Aufmaß des Gewindebohrers sollte durch Versuche ermittelt werden. / The increase of effective-Ø (A) caused by electroplating (Thickness of coating T) depends on the thread angle (α). The oversize of the tap should be determined through tests.  $(A = T \cdot f \text{ mit } f = 2 / \sin(\alpha/2))$

Flankenwinkel (α) / thread angle (α)	30°	47,5°	55°	60°	80°	90°
f	7,727	4,966	4,331	4,000	3,111	2,828

Flanken-Ø Aufmaß auf Gewindebohrer-Toleranz 6H/ISO 2 / oversize on effective-Ø based on tolerance 6H/ISO 2														
	6G/ISO3	7G		6G/ISO3	7G		6G/ISO3	7G		6G/ISO3	7G		6G/ISO3	7G
M2	0,014	0,028	M 27	0,042	0,084	M 8 x 1	0,024	0,048	M 17 x 1,5	0,030	0,060	M 27 x 1	0,026	0,052
M 2,5	0,015	0,030	M 30	0,045	0,090	M 9 x 1	0,024	0,048	M 18 x 1	0,025	0,050	M 27 x 1,5	0,032	0,064
M 3	0,016	0,032	M 33	0,045	0,090	M 10 x 0,5	0,018	0,036	M 18 x 1,5	0,030	0,060	M 27 x 2	0,036	0,072
M 3,5	0,018	0,036	M 36	0,047	0,094	M 10 x 0,75	0,021	0,042	M 18 x 2	0,034	0,068	M 28 x 1	0,026	0,052
M 4	0,019	0,038	M 39	0,047	0,094	M 10 x 1	0,024	0,048	M 20 x 1	0,025	0,050	M 28 x 1,5	0,032	0,064
M 5	0,020	0,040	M 42	0,050	0,100	M 10 x 1,25	0,025	0,050	M 20 x 1,5	0,030	0,060	M 28 x 2	0,036	0,072
M 6	0,024	0,048	M 45	0,050	0,100	M 11 x 1	0,024	0,048	M 20 x 2	0,034	0,068	M 30 x 1	0,026	0,052
M 8	0,025	0,050	M 48	0,053	0,106	M 12 x 1	0,025	0,050	M 22 x 1	0,025	0,050	M 30 x 1,5	0,032	0,064
M 10	0,028	0,056	M 52	0,053	0,106	M 12 x 1,25	0,028	0,056	M 22 x 1,5	0,030	0,060	M 30 x 2	0,036	0,072
M 12	0,032	0,064	M 56	0,056	0,112	M 12 x 1,5	0,030	0,060	M 22 x 2	0,034	0,068	M 33 x 1,5	0,032	0,064
M 14	0,034	0,068	M 4 x 0,5	0,016	0,032	M 13 x 1	0,025	0,050	M 24 x 1	0,026	0,052	M 33 x 2	0,036	0,072
M 16	0,034	0,068	M 5 x 0,5	0,016	0,032	M 14 x 1	0,025	0,050	M 24 x 1,5	0,032	0,064	M 36 x 1,5	0,032	0,064
M 18	0,036	0,072	M 6 x 0,5	0,018	0,036	M 14 x 1,25	0,028	0,056	M 24 x 2	0,036	0,072	M 36 x 2	0,036	0,072
M 20	0,036	0,072	M 6 x 0,75	0,021	0,042	M 14 x 1,5	0,030	0,060	M 25 x 1,5	0,032	0,064	M 36 x 3	0,042	0,084
M 22	0,036	0,072	M 8 x 0,5	0,018	0,036	M 16 x 1	0,025	0,050	M 26 x 1	0,026	0,052	M 40 x 1,5	0,032	0,064
M 24	0,042	0,084	M 8 x 0,75	0,021	0,042	M 16 x 1,5	0,030	0,060	M 26 x 1,5	0,032	0,064	M 40 x 3	0,042	0,084

## Whitworth Rohrgewinde

Bei Verwendung von Whitworth Rohrgewinden ist grundsätzlich zwischen im Gewinde dichtende Verbindungen und rein mechanischen Verbindungen ohne Dichteigenschaften zu unterscheiden.

Die internationale Normung der im Gewinde dichtenden Verbindungen wurde vereinheitlicht. Die ISO 7 wurde mit der EN 10226 in eine europäische Norm überführt und in nationalen Normen übernommen. Die bisher verwendeten entsprechenden nationalen Normen wie die DIN 2999 oder die BS 21 wurden zurückgezogen.

Die nicht im Gewinde dichtende Verbindung nach DIN ISO 228 sieht zylindrische Innen- und Außengewinde vor. Die Gewindedurchmesser und Steigungen stimmen mit denen der Dichtgewinde überein.

Norm:	ISO 7/1 / DIN EN 10226		DIN ISO 228 Teil 1
<b>Titel der Norm:</b>	Rohrgewinde für im Gewinde dichtende Verbindungen		Rohrgewinde für nicht im Gewinde dichtende Verbindungen
<b>Art der Verbindung:</b>	Im Gewinde dichtende Verbindung		Nicht im Gewinde dichtende Verbindung
<b>Innen-, Außengewinde:</b>	Innengewinde zylindrisch	Innengewinde konisch ( 1:16)	Innen- und Außengewinde zylindrisch
<b>Gewindekurzzeichen Norm:</b>	<b>Rp</b> ISO 7/1 DIN EN 10226/1	<b>Rc</b> ISO 7/1 DIN EN 10226/2	<b>R</b> ISO 7/1 DIN EN 10226 1 + 2
<b>Ausführung der Lehren:</b>	konische Gewindegrenzlehndorn (1) gem. ISO 7/2 (2000) und DIN EN 10226-3a)		zylindrische Gewindegrenzlehrring (3) gem. ISO 7/2 und DIN EN 10226-3a)

- a) Die Lehrensysteme der ISO 7/2 (2000) und der DIN EN 10226/3 sind identisch. Neben den hier aufgeführten Lehren sind weitere Lehren für spezielle Anforderungen definiert. Die genannten Normen wurden überarbeitet und weichen von der ISO 7/2 (1982), der DIN 2999 Teil 2 bis 6 sowie der BS 21 zum Teil ab. Werkstückprüfungen mit unterschiedlichen Lehrensystemen können zu abweichenden Ergebnissen führen.

G <sup>1)</sup>	P Gg <sup>2)</sup>	p [mm]	A-Ø d = D	FI-Ø d <sub>2</sub> = D <sub>2</sub>	Kern-Ø d <sub>1</sub> = D	Rp / Rc R	a [mm]	Toleranzen Innengewinde FI-Ø [mm]	Toleranzen Außengewinde U	Toleranzen Außengewinde mm
1/16	28	0,907	7,723	7,142	6,561	1/16	4	±0,071	±1.1/4	±1 ±0,9
1/8	28	0,907	9,728	9,147	8,566	1/8	4	±0,071	±1.1/4	±1 ±0,9
1/4	19	1,337	13,157	12,301	11,445	1/4	6	±0,104	±1.1/4	±1 ±1,3
3/8	19	1,337	16,662	15,806	14,950	3/8	6,4	±0,104	±1.1/4	±1 ±1,3
1/2	14	1,814	20,955	19,793	18,631	1/2	8,2	±0,142	±1.1/4	±1 ±1,8
5/8	14	1,814	22,911	21,749	20,587					
3/4	14	1,814	26,441	25,279	24,117	3/4	9,5	±0,142	±1.1/4	±1 ±1,8
7/8	14	1,814	30,201	29,039	27,877					
1	11	2,309	33,249	31,770	30,291	1	10,4	±0,18	±1.1/4	±1 ±2,3
1.1/8	11	2,309	37,897	36,418	34,939					
1.1/4	11	2,309	41,910	40,431	38,952	1.1/4	12,7	±0,18	±1.1/4	±1 ±2,3
1.1/2	11	2,309	47,803	46,324	44,845	1.1/2	12,7	±0,18	±1.1/4	±1 ±2,3
1.3/4	11	2,309	53,746	52,267	50,788					
2	11	2,309	59,614	58,135	56,656	2	15,9	±0,18	±1.1/4	±1 ±2,3
2.1/4	11	2,309	65,710	64,231	62,752					
2.1/2	11	2,309	75,184	73,705	72,226	2.1/2	17,5	±0,217	±1.1/2	±1.1/2 ±3,5
2.3/4	11	2,309	81,534	80,055	78,576					
3	11	2,309	87,884	86,405	84,926	3	20,6	±0,217	±1.1/2	±1.1/2 ±3,5
3.1/2	11	2,309	100,330	98,851	97,372					
4	11	2,309	113,030	111,551	110,072	4	25,4	±0,217	±1.1/2	±1.1/2 ±3,5

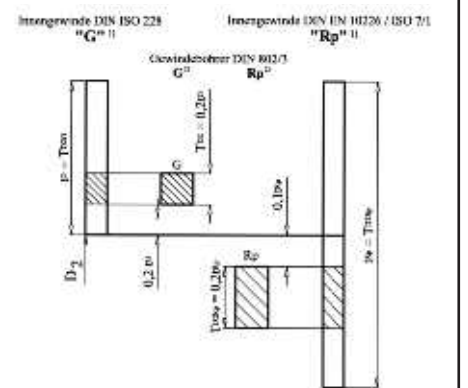

Toleranzen für Whitworth Rohrgewinde an Innengewinden und Gewindebohrern

- 1) Die Toleranzen des „G“ Innengewindes entsprechen der im Plus liegenden Toleranz des „Rp“ Innengewindes
- 2) Hahnreiter Gewindebohrer werden mit eingeschränkten Toleranzen gefertigt
- 3) L<sub>m</sub> = Prüflänge (Nennmaß)

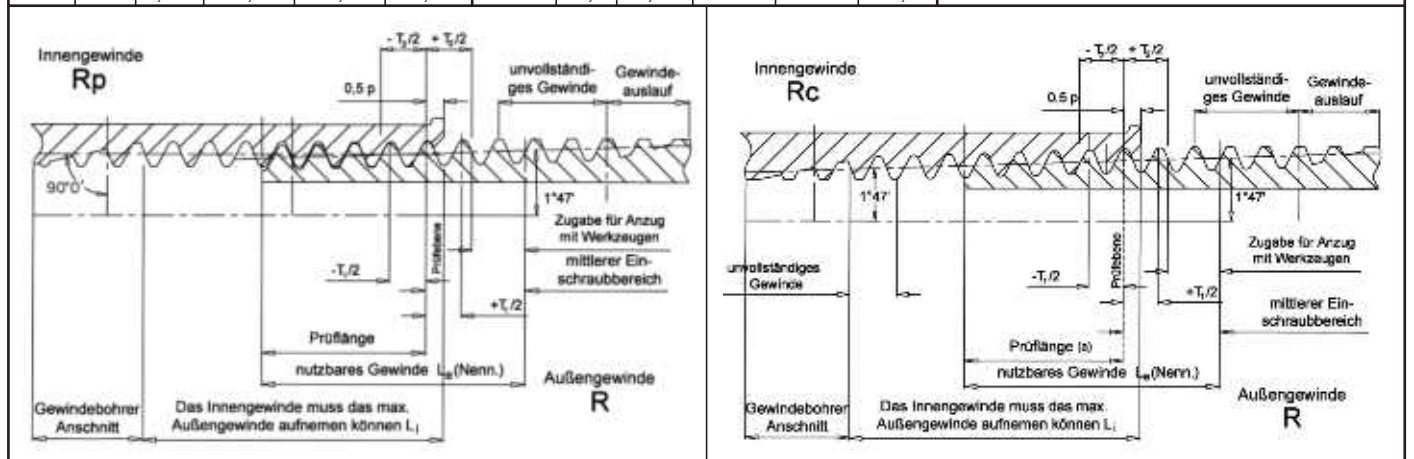

# Rohrgewinde

## Amerikanisches Rohrgewinde

		Rohrgewinde	Außengewinde	Innengewinde	Bemerkungen
NPT		„allg. Anwendung“	konisch	konisch	
NPTF		trockendichtend	konisch	konisch	
NPSC	C=Verschraubung	„allg. Anwendung“	konisch (NPT)	zylindrisch	Profil wie NPT
NPSM	M=mechanisch	Befestigungsgewinde	zylindrisch	zylindrisch	UN-Gewindeprofil
NPSF		trockendichtend	konisch (NPTF)	zylindrisch	Profil wie NPTF
NPSI		trockendichtend	kon. (NPT-SAE / NPTF)	zylindrisch	Im Durchmesser etwas größer als NPSF, bei gleicher Toleranz
NPSL	L=Gegenmutter	Gegenmutterverbindung	zylindrisch	zylindrisch	

NPT-, NPSC-, NPSM- und NPSL-Gewinde werden in ANSI/ASME B1.20 festgelegt, NPTF, NPSF und NPSI-Gewinde in ANSI B1.20.3

Fitting	Rohr	L <sub>3</sub>	L <sub>1</sub>	L <sub>5</sub>	2P	v	L <sub>2</sub>	L <sub>4</sub>	NPT	D	P	P	E <sub>1</sub>	L <sub>1</sub>	L <sub>1</sub>	L <sub>2</sub>	L <sub>3</sub> (3Gg)	L <sub>5</sub>
										[mm]	[Gg/°]	[mm]	Ø-Flanke	[mm]	[Gg]	[mm]	[mm]	[mm]
									1/16	7,938	27	0,941	7,142	4,064	4,32	6,632	2,822	4,750
									1/8	10,287	27	0,941	9,489	4,102	4,36	6,703	2,822	4,821
									1/4	13,716	18	1,411	12,487	5,786	4,10	10,206	4,234	7,384
									3/8	17,145	18	1,411	15,926	6,096	4,32	10,358	4,234	7,536
									1/2	21,336	14	1,814	19,772	8,128	4,48	13,556	5,443	9,929
									3/4	26,670	14	1,814	25,117	8,611	4,75	13,861	5,443	10,234
									1	33,401	11,5	2,209	31,461	10,160	4,60	17,343	6,627	12,924
									1.1/4	42,164	11,5	2,209	40,218	10,668	4,83	17,953	6,627	13,536
									1.1/2	48,260	11,5	2,209	46,287	10,668	4,83	18,377	6,627	13,960
									2	60,325	11,5	2,209	58,325	11,074	5,01	19,215	6,627	14,798
									2.1/2	73,025	8	3,175	70,159	17,323	5,46	28,892	6,350	22,542
									3	88,900	8	3,175	86,068	19,456	6,13	30,480	6,350	24,130
									3.1/2	101,600	8	3,175	98,776	20,853	6,57	31,750	6,350	25,400
									4	114,300	8	3,175	111,433	21,438	6,75	33,020	6,350	26,670

Darstellung NPT-Gewinde

D	Außen-Ø des Rohrs	L <sub>3</sub>	Einschraublänge bei Kraftverschraubung für Innengewinde
E <sub>1</sub>	Flanken-Ø nach L <sub>1</sub>	L <sub>4</sub>	Außengewinde
L <sub>1</sub>	Einschraublänge von Hand	L <sub>5</sub>	Außengewinde mit voll ausgeschnittenem Gewindeprofil (auf die Länge von 2 P hinter L <sub>5</sub> ist das Außengewinde an den Gewindespitzen nicht voll ausgebildet, da der Kegel des Gewindeprofils den zylindrischen Rohr-außen-Ø schneidet).
L <sub>2</sub>	nutzbares Außengewinde	v	unvollständiges Profil durch Anschnitt des Gewindeschneidwerkzeuges

Die Gewindeprofile von NPT und NPTF Gewinde unterscheiden sich durch die Breiten der Profilabflachung im Außen- und Kern-Ø des Gewindes. Beim NPTF Profil ergibt sich eine Überschneidung der Profile von Innen- und Außengewinde, wodurch bei Verschraubung eine druckdichte Verbindung ohne Verwendung von Dichtmitteln entsteht. Beim NPTF Gewinde sind die Längen L<sub>1</sub> + L<sub>3</sub> sowie L<sub>2</sub> um 1 Gang verlängert.

P [G/°]	NPT				NPTF			
	Innengewinde		Außengewinde		Innengewinde		Außengewinde	
	min.	max.	min.	max.	min.	max.	min.	max.
	Breite der Profilabflachung		Profilhöhen		Breite der Profilabflachung			
					Grund		Spitze	
	min.	max.	min.	max.	min.	max.	min.	max.
27	0,036	0,104	0,634	0,753	0,102	0,152	0,051	0,102
18	0,053	0,145	0,974	1,129	0,127	0,178	0,076	0,127
14	0,069	0,163	1,288	1,451	0,127	0,178	0,076	0,127
11 1/2	0,084	0,185	1,590	1,767	0,152	0,229	0,102	0,152
8	0,122	0,229	2,356	2,540	0,203	0,279	0,152	0,203



# Pipe Threads

## Whitworth Pipe Threads

Using Whitworth pipe threads it has to be distinguished between those threads which are thought to be sealing on the thread and those which produce a mechanical connection without sealing function.

International standardization of those threads producing a sealing connection has been united. ISO 7 has been transferred to EN 10226 and has been taken over to national standards. Those national standards that have been used before as DIN 2999 or BS 21 have been withdrawn.

The thread connection given in DIN ISO 228 is not meant to be sealing on the thread. Basic thread dimensions and pitch is common to the sealing threads.

Standard:	ISO 7/1 / DIN EN 10226		DIN ISO 228 Part 1
Title of standard:	Pipe threads where pressure-tight joints are made on the thread		Pipe threads where pressure-tight joints are not made on the threads
Kind of thread connection:	Threads which are sealing on the thread		Threads which are not sealing on the thread
Internal external thread:	cylindrical	internal thread taper (1:16)	external thread taper (1:16)
Short sign for thread standard:	<b>Rp</b> ISO 7/1 DIN EN 10226/1	<b>Rc</b> ISO 7/1 DIN EN 10226/2	<b>R</b> ISO 7/1 DIN EN 10226 1 + 2
Design of gauges:	Taper thread plug gauge (1) according to ISO 7/2 (2000) and DIN EN 10226-3 a)		Cylindrical thread ring gauge (3) according to ISO 7/2 and a) DIN EN 10226-3 a)

a) Gauge systems of ISO 7/2 (2000) and DIN EN 10226 are identical. There are additional gauges for special purposes specified. Those standards have been reworked and differ to ISO 7/2 (1982), DIN 2999 (part 2 to 6) and BS 21. Checking parts with gauges which belong to different gauge systems may lead to different results.

G	P [TPI]	p [mm]	Out.-Ø d = D	Pitch-Ø d <sub>2</sub> = D <sub>2</sub>	Minor-Ø d <sub>1</sub> = D <sub>1</sub>	Rp / Rc R	a	Tolerances of internal thread pitch-Ø [mm]	Toleran. of external thr. turns	mm
1/16	28	0,907	7,723	7,142	6,561	1/16	4	±0,071	±1.1/4	±1 ±0,9
1/8	28	0,907	9,728	9,147	8,566	1/8	4	±0,071	±1.1/4	±1 ±0,9
1/4	19	1,337	13,157	12,301	11,445	1/4	6	±0,104	±1.1/4	±1 ±1,3
3/8	19	1,337	16,662	15,806	14,950	3/8	6,4	±0,104	±1.1/4	±1 ±1,3
1/2	14	1,814	20,955	19,793	18,631	1/2	8,2	±0,142	±1.1/4	±1 ±1,8
5/8	14	1,814	22,911	21,749	20,587					
3/4	14	1,814	26,441	25,279	24,117	3/4	9,5	±0,142	±1.1/4	±1 ±1,8
7/8	14	1,814	30,201	29,039	27,877					
1	11	2,309	33,249	31,770	30,291	1	10,4	±0,18	±1.1/4	±1 ±2,3
1.1/8	11	2,309	37,897	36,418	34,939					
1.1/4	11	2,309	41,910	40,431	38,952	1.1/4	12,7	±0,18	±1.1/4	±1 ±2,3
1.1/2	11	2,309	47,803	46,324	44,845	1.1/2	12,7	±0,18	±1.1/4	±1 ±2,3
1.3/4	11	2,309	53,746	52,267	50,788					
2	11	2,309	59,614	58,135	56,656	2	15,9	±0,18	±1.1/4	±1 ±2,3
2.1/4	11	2,309	65,710	64,231	62,752					
2.1/2	11	2,309	75,184	73,705	72,226	2.1/2	17,5	±0,217	±1.1/2	±1.1/2 ±3,5
2.3/4	11	2,309	81,534	80,055	78,576					
3	11	2,309	87,884	86,405	84,926	3	20,6	±0,217	±1.1/2	±1.1/2 ±3,5
3.1/2	11	2,309	100,330	98,851	97,372					
4	11	2,309	113,030	111,551	110,072	4	25,4	±0,217	±1.1/2	±1.1/2 ±3,5

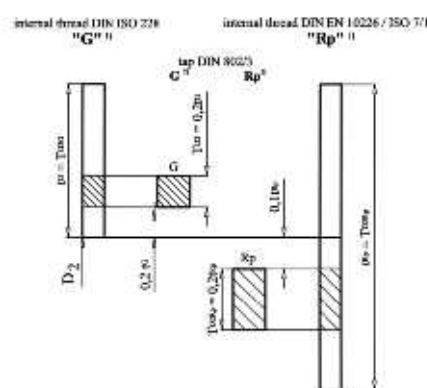

Tolerances for internal Whitworth pipe threads and taps.

- 1) Tolerances of internal „G“ thread correspond to the „+“ part of „Rp“ internal thread tolerances
- 2) Hahnreiter taps are being produced with closer tolerance band
- 3) L<sub>m</sub> = gauge length (nominal)

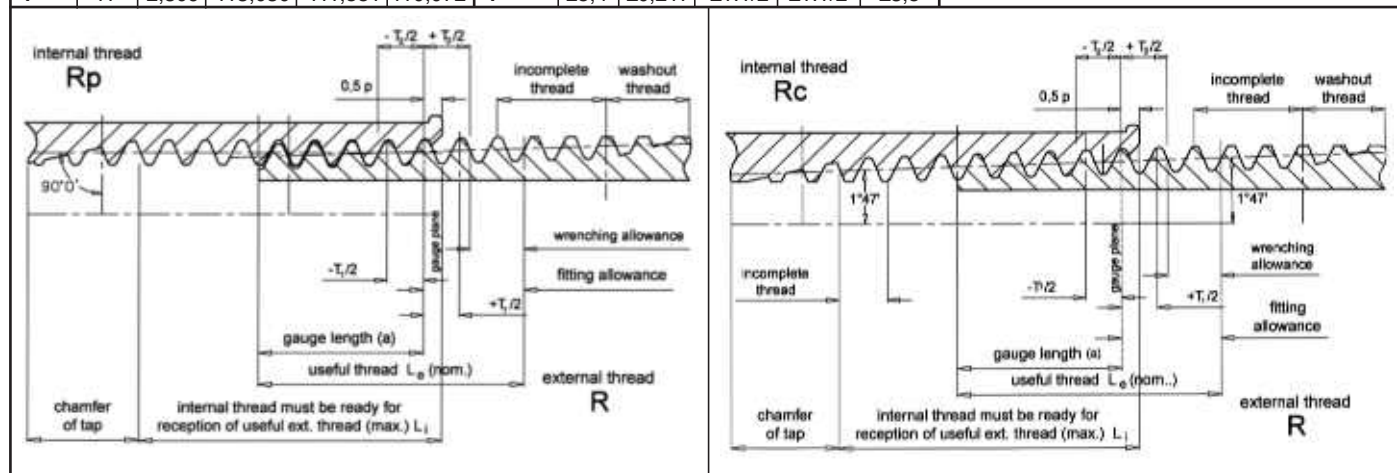

# Pipe Threads

## American Pipe Threads

		pipe thread	external thread	internal thread	remarks
<b>NPT</b>		„general purpose”	taper	taper	
<b>NPTF</b>		dry sealing	taper	taper	
<b>NPSC</b>	C=coupling	„general purpose”	taper (NPT)	cylindrical	profile as NPT
<b>NPSM</b>	M=mechanical	fastening thread	cylindrical	cylindrical	UN-thread profile
<b>NPSF</b>		dry sealing	taper (NPTF)	cylindrical	profile as NPTF
<b>NPSI</b>		dry sealing	taper (NPT-SAE / NPTF)	cylindrical	thread diameter slightly increased with same width of tolerance field
<b>NPSL</b>	L=Locknut		cylindrical	cylindrical	

NPT-, NPSC-, NPSM- and NPSL-thread are defined in ANSI/ASME B1.20.1, NPTF, NPSF and NPSI-thread are given in ANSI B1.20.3

fitting	pipe	line pitch-ø	L <sub>3</sub>	L <sub>1</sub>	L <sub>5</sub>	2P	v	L <sub>2</sub>	L <sub>4</sub>	D	NPT	D	P	P	E <sub>1</sub>	L <sub>1</sub>	L <sub>1</sub>	L <sub>2</sub>	L <sub>3</sub> (3Turns)	L <sub>5</sub>
												[mm]	[TPI]	[mm]	Ø-pitch	[mm]	[Gg]	[mm]	[mm]	[mm]
											1/16	7,938	27	0,941	7,142	4,064	4,32	6,632	2,822	4,750
											1/8	10,287	27	0,941	9,489	4,102	4,36	6,703	2,822	4,821
											1/4	13,716	18	1,411	12,487	5,786	4,10	10,206	4,234	7,384
											3/8	17,145	18	1,411	15,926	6,096	4,32	10,358	4,234	7,536
											1/2	21,336	14	1,814	19,772	8,128	4,48	13,556	5,443	9,929
											3/4	26,670	14	1,814	25,117	8,611	4,75	13,861	5,443	10,234
											1	33,401	11,5	2,209	31,461	10,16	4,60	17,343	6,627	12,924
											1.1/4	42,164	11,5	2,209	40,218	10,668	4,83	17,953	6,627	13,536
											1.1/2	48,260	11,5	2,209	46,287	10,668	4,83	18,377	6,627	13,960
											2	60,325	11,5	2,209	58,325	11,074	5,01	19,215	6,627	14,798
											2.1/2	73,025	8	3,175	70,159	17,323	5,46	28,892	6,350	22,542
											3	88,900	8	3,175	86,068	19,456	6,13	30,480	6,350	24,130
											3.1/2	101,600	8	3,175	98,776	20,853	6,57	31,750	6,350	25,400
											4	114,300	8	3,175	111,433	21,438	6,75	33,020	6,350	26,670

portrayal of NPT-thread

<b>D</b>	outside-Ø of pipe	<b>L<sub>3</sub></b>	wrenching allowance
<b>E<sub>1</sub></b>	pitch-Ø at length L <sub>1</sub>	<b>L<sub>4</sub></b>	length of external thread
<b>L<sub>1</sub></b>	position of handtight engagement	<b>L<sub>5</sub></b>	external thread with complete thread profile (on the length of 2 P beyond L <sub>5</sub> external thread profile is incomplete at the top of the threads because the cone of thread profile meets the cylindrical outside diameter of the pipe)
<b>L<sub>2</sub></b>	useful external thread	<b>v</b>	incomplete thread produced by the chamfer of thread cutting tool

The difference between thread profile of NPT and NPTF threads is the width of flat of profile on the outside and minor diameter. NPTF thread has got an overlap of profiles of internal and external thread. By this method, drysealing property is achieved. Compared to the NPT, NPTF is one thread longer on L<sub>1</sub> + L<sub>3</sub> and L<sub>2</sub>.

P [TPI]	NPT				NPTF			
	internal thread				internal thread			
	external thread				external thread			
width of flat of profile		height of profile		width of flat of profile				
min.		max.		ground		top		
min.		max.		min.	max.	min.	max.	
27	0,036	0,104	0,634	0,753	0,102	0,152	0,051	0,102
18	0,053	0,145	0,974	1,129	0,127	0,178	0,076	0,127
14	0,069	0,163	1,288	1,451	0,127	0,178	0,076	0,127
11 1/2	0,084	0,185	1,590	1,767	0,152	0,229	0,102	0,152
8	0,122	0,229	2,356	2,540	0,203	0,279	0,152	0,203

# Gewindeschneiden - Einsatzfallbeschreibung



Wilh. Becker GmbH & Co.KG, D-42855 Remscheid  
 Tel.: +49 (0) 2191 378-0 · Fax: +49 (0) 2191 378-78  
 E-mail: info@hahnreiter.de · www.hahnreiter.de

<b>Kunde</b>		<b>Telefon</b>	
<b>Sachbearbeiter</b>		<b>Fax</b>	<b>e-mail</b>
		<b>Datum</b>	

## Werkstückdaten

<b>Gewindeabmessung</b>	<b>Toleranz</b>	<b>Gewinderichtung</b> O Rechts    O Links
<b>Material</b>	<b>Werkstoff Nr.</b>	<b>Spanform</b> O langspanend O kurzspanend O Bröckelspan
<b>Festigkeit</b> [N/mm <sup>2</sup> ]	<b>Bruchdehnung</b> [%]	
<b>Material Charakteristik</b>		

<b>Kernlochform</b> <input type="radio"/> Durchgangsloch <input type="radio"/> Sackloch	<b>Kernloch-Ø (BØ)</b>	
	<b>Kernlochtiefe (t<sub>B</sub>)</b>	
	<b>Gewindetiefe (t)</b>	

## Maschinendaten

<b>Maschine</b>	<input type="radio"/> ohne <input type="radio"/> Leitspindel	<b>Steigungsführung</b>	
Typ		Programmierung Axialvorschub Vorlauf [%]    Rücklauf [%]	
Baujahr	<input type="radio"/> CNC-Achse		
<b>Bearbeitungslage</b> O Horizontal O Vertikal	<b>Schnittgeschwindigkeit</b>		
	$V = D \cdot \pi \cdot N / 1.000$		$N = 1.000 \cdot V / D \cdot \pi$
<b>Gewindeschneidfutter</b> O starr O mit Längenausgleich (Zugrichtung) O Längenausgleich (Druckrichtung) O mit Überlastkupplung	<b>Kühlmittelzufuhr</b> O von außen (manuell) O von außen (Umlaufschmierung) O Innere Kühlmittelzufuhr O Minimalmengenschmierung (MMS)	<b>Schmiermittel</b> O Schneidöl O Emulsion ..... % Typ:	

## Erfahrungen

<b>Hersteller</b> O HAHNREITER O .....	<b>Type</b>	<b>Ausführung</b>	<b>Ergebnis</b>
<b>Verhalten bei Standzeitende</b>			
<b>Bemerkungen</b>			

## Anlagen

Werkzeugmuster / Werkstücke / Werkstück-Zeichnungen

## Tapping - Specification of Application



Wilh. Becker GmbH & Co.KG, D-42855 Remscheid  
 Phone: +49 2191 378-0 · Telefax: +49 2191 378-78  
 E-mail: info@hahnreiter.de · www.hahnreiter.de

<b>customer</b>	<b>phone</b>		
<b>name</b>	<b>fax</b>	<b>e-mail</b>	<b>date</b>

### Workpiece Information

<b>thread size</b>	<b>tolerance</b>	<b>thread direction</b> <input type="radio"/> right <input type="radio"/> left
<b>material</b>	<b>material standard</b>	<b>shape of chips</b> <input type="radio"/> long chipping <input type="radio"/> short chipping <input type="radio"/> brittle chipping
<b>tensile strength</b> [N/mm <sup>2</sup> ]	<b>elongation</b> [%]	
<b>material characteristics</b>		

<b>kind of core hole</b> <input type="radio"/> through hole <input type="radio"/> blind hole	<b>core hole-Ø (BØ)</b>	
	<b>depth of core hole (t<sub>B</sub>)</b>	
	<b>length of thread to be cut (t)</b>	

### Machine information

<b>machine</b>	<input type="radio"/> without <input type="radio"/> leadscrew	<b>pitch control</b>	
Type		programming of axial infeed	
year when built	<input type="radio"/> CNC control	cutting [%]	reversing [%]
<b>machining position</b> <input type="radio"/> horizontal <input type="radio"/> vertical	<b>cutting speed</b>		
	$V = D \cdot \pi \cdot N / 1.000$		$N = 1.000 \cdot V / D \cdot \pi$
<b>type of tapping head</b> <input type="radio"/> rigid <input type="radio"/> length compensation on tension <input type="radio"/> length compensation on compression <input type="radio"/> with overload clutch	<b>coolant supply</b> <input type="radio"/> from outside (manually) <input type="radio"/> from outside (circle) <input type="radio"/> internal coolant supply <input type="radio"/> minimum quantity lubrication (MMS)	<b>coolant</b> <input type="radio"/> cutting oil <input type="radio"/> emulsion ..... % type:	

### Experiences

<b>producer</b> <input type="radio"/> HAHNREITER <input type="radio"/> .....	<b>article</b>	<b>specification</b>	<b>tool-life</b>
<b>reasons for end of tool-life</b>			
<b>remarks</b>			

### enclosures

samples of tools / workpieces / drawings of workpiece

## Nachschleifen von Gewindebohrern Regrinding of taps

Zunehmender Verschleiß an Gewindebohrern führt zu verschlechterter Oberflächengüte und Maßhaltigkeit. Aufgrund erhöhter Schnittkräfte kann es zu Werkzeugbruch kommen. Bitte berücksichtigen Sie, dass sich der Verschleiß am Gewindebohrer nicht linear entwickelt - wir empfehlen deshalb ein häufigeres Nachschleifen des Bohrers, um eine optimale Gesamtstandzeit zu erreichen.

*Increasing wear on taps lead to impair surface quality of thread and may cause thread diameter problems. Increasing torque may lead to breakage of tap. Please consider that wear will not develop linear - therefore we recommend to regrind the tap frequently to achieve maximum overall tool life.*

### Nachschleifen des Spanwinkels $\gamma_p$ / *Regrinding of rake angle $\gamma_p$*

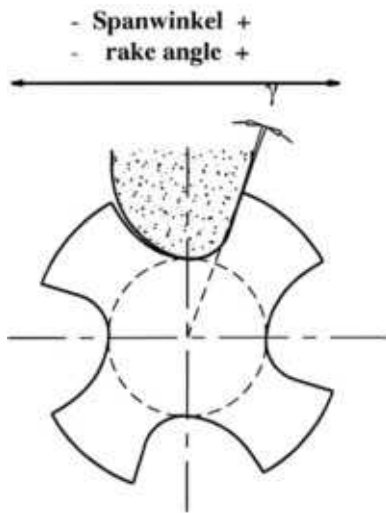

Der Spanwinkel sollte entsprechend dem zu bearbeitenden Material geschliffen werden. Eine Veränderung des Spanwinkels kann durch Verschiebung der Schleifscheibe, wie dargestellt, erreicht werden. Der Spanwinkel muss am ersten vollen Zahn gemessen werden, bei Schälanschnittbohrern in der Mitte des Anschnitts ( $l_4 / 2$ ).

Beim Nachschleifen der Spannuten ist besonders darauf zu achten, dass die Nutenteilung korrekt eingehalten wird, ansonsten kann der Gewindebohrer zu groß schneiden.

*Rake angle should be ground depending on the material that is to be machined. Modification of rake angle can be achieved by moving the grinding wheel as shown. The rake angle should be measured at the first full profile thread, rake angle of spiral point taps has be measured at mid of chamfer ( $l_4 / 2$ ).  
Regrinding the flutes care has to be taken that the indexing is restored properly, otherwise the tap might cut oversize*

	Zerspanungsgruppe		$\gamma_p$		Zerspanungsgruppe	$\gamma_p$
1.1 Baustähle <i>General structural steel</i>	1.1.0	< 500 N/mm <sup>2</sup>	12 - 17	3.20 Kupfer un-/niedriglegiert <i>Copper, low alloyed</i>	3.20	17 - 22
	1.1.1	500-800 N/mm <sup>2</sup>	13 - 15			
	1.1.2	800-1200 N/mm <sup>2</sup>	10 - 12			
1.2 Automatenstähle <i>Free cutting steel</i>	1.2.1	500-800 N/mm <sup>2</sup>	12 - 14	3.21 Kupfer-Zinklegierung, Messing kurzspanend <i>short chipping brass</i>	3.21	0 - 4
	1.2.2	800-1200 N/mm <sup>2</sup>	10 - 12			
1.3 Kaltfließpressstähle <i>Steel for cold extrusion</i>	1.3.1	500-800 N/mm <sup>2</sup>	12 - 15	3.22 Messing langspanend <i>long chipping brass</i>	3.22	10 - 14
1.4 Einsatzstähle <i>Case hardening steel</i>	1.4.1	500-800 N/mm <sup>2</sup>	12 - 15	3.23 Kupfer-Aluminiumlegierung, Aluminium Bronze, langspanend <i>Copper-aluminium alloys, long chipping</i>	3.23	5 - 10
	1.4.2-1.4.3	> 800 N/mm <sup>2</sup>	10 - 12			
1.5 Nitrierstähle <i>Nitriding steel</i>	1.5.1	500-800 N/mm <sup>2</sup>	12 - 15	3.24 Kupfer-Zinnlegierung, Zinnbronze Rotguss, kurzspanend <i>Copper-zinc alloys, short chipping</i>	3.24	5 - 10
	1.5.2-1.5.3	> 800 N/mm <sup>2</sup>	10 - 12			
1.6 Vergütungsstähle <i>Heat-treatable steel</i>	1.6.1	500-800 N/mm <sup>2</sup>	12 - 15	4.14 Aluminium und Aluminiumknetlegierung <i>Unalloyed aluminium and wrought alu-alloys</i>	4.14	17 - 22
	1.6.2-1.6.3	> 800 N/mm <sup>2</sup>	10 - 12			
1.7-8 Werkzeugstähle / HSS <i>Tool steel / HSS</i>	1.7-1.8		10 - 12	4.15 Aluminiumgusslegierung <10 % Si <i>Aluminium casting alloys &lt; 10 % Si</i>	4.15	12 - 15
1.9 Nichtrostende Stähle <i>Stainless steel</i>	1.9.4	ferritisch/ferr.-mart.	10 - 12			
	1.9.5	austenitisch	10 - 12	4.16 Aluminiumgusslegierung >10 % Si <i>Aluminium casting alloys &gt; 10 % Si</i>	4.16	10 - 12
1.10 Hitzebeständige Stähle <i>Heat-resisting steel</i>	1.10		10 - 12	4.17 Magnesiumlegierungen <i>Magnesium alloys</i>	4.17	5 - 10
2.11 Grauguss <i>Grey cast iron</i>	2.11		4 - 6	4.18 Zinklegierungen <i>Zinc alloys</i>	4.18	12 - 15
2.12 Sphäroguss <i>Spheroidal graphite cast iron</i>	2.12		8 - 10	5.25 Nickellegierungen <i>Nickel alloys</i>	5.25	5 - 7
2.13 Temperguss <i>Malleable cast iron</i>	2.13		8 - 10	5.26 Titan und Titanleg. <i>Titanium alloys</i>	5.26	-5 - 3 (neg.)



## Nachschleifen von Gewindebohrern Regrinding of taps

Beim Nachschleifen von spiralgenuteten Gewindebohrern muss die Schleifscheibe in den Spiralwinkel eingeschwenkt werden. Bei spiralgenuteten HAHNREITER Gewindebohrern sind Spiralsteigung und Spiralwinkel auf dem Schaft vermerkt. Der Einschwenkwinkel der Schleifscheibe sollte um ca. 1-2° größer gewählt werden als der Spiralwinkel (auch bei geraden Nuten) um eine geringere Kontaktfläche zwischen Werkstück und Schleifscheibe zu erreichen.

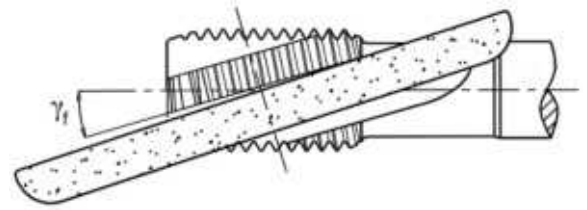

*When regrinding spiral fluted taps the grinding wheel has to be swivelled to helix angle. Spiral fluted HAHNREITER taps are labelled with helix angle and pitch of helix on the shank. Swivelling angle of grinding should be chosen 1-2° bigger than helix angle (even while grinding straight flutes) to reduce contact between workpiece and grinding wheel.*

Beim Nachschärfen des Schälanschnitts sind folgende Werte anzustreben / grinding spiral point the following is recommended:

Schälanschnittwinkel horizontal ( $\gamma_{fA}$ ) spiral point angle (horizontal)	9 – 12°
Schälanschnittwinkel vertikal ( $\lambda$ ) spiral point angle (vertical)	6 – 8°

Beim Nachschleifen des Spanwinkels muss der Verschleiß der Schleifscheibe (auch bei CBN-Schleifscheiben) überwacht werden und die Scheibe entsprechend nachprofiliert werden. Ansonsten können falsche Spanwinkel erreicht werden.

*While regrinding rake angle the wear of the grinding wheel should be watched (even if CBN wheels are in use) otherwise wrong rake angles might be achieved.*

## Nachschärfen des Anschnitts / Regrinding of chamfer

Beim Nachschleifen des Anschnitts muss die Achse des Gewindebohrers um den Anschnittwinkel  $\chi_r$  zur Achse der Schleifscheibe eingeschwenkt werden. Hinweise zur Bestimmung des Anschnittwinkels und -durchmessers entnehmen Sie bitte dem Abschnitt "Anschnittformen an Gewindebohrern" Seite T17. Wichtig ist, dass der Durchmesser des Anschnitts nicht zu groß gewählt wird, da es sonst zum stirnseitigen Auflaufen des Bohrers und damit zu geringen Standzeiten kommt. Soll der Anschnitt gekürzt werden, muss der Anschnittwinkel vergrößert und der Bohrer anschließend gekürzt werden.

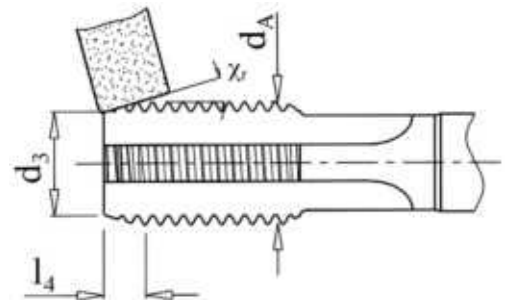

*When regrinding the chamfer the axis of the tap has to be swivelled by the chamfer angle relative to the axis of the grinding wheel. For information about computing chamfer angle and -diameter please see chapter "Chamfer forms on taps" page T17. It is very important that the diameter of the chamfer is not produced too big because otherwise the tap's face might run upon the component that is to be cut. If the chamfer is to be shortened chamfer angle has to be increased before shortening the tap.*

Der Anschnittfreiwinkel  $\alpha_p$  sollte an die Geometrie des Gewindebohrers angepasst werden. Die Messuhr sollte auf dem mittleren Anschnittgang positioniert werden.

*The chamfer relief angle  $\alpha_p$  should be adopted to the geometry of the tap. The measuring dial should be positioned at the middle of the chamfer.*

Anschnittform chamfer form	$\alpha_p$	$S_5 = h \cdot m$ $h^*$
B (Schälanschnitt 4-5 Gg.)	3°30'	0,06
C (2-3 Gg) / E (1-2 Gg)	2°0' - 2°30'	0,035 - 0,045
Automat MS + extrem kurze Anschnitte / extra short chamfer	3°30' - 5°45'	0,06 - 0,1

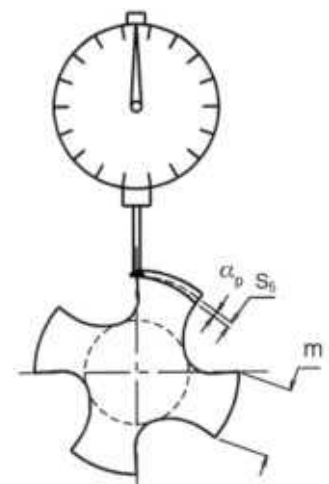

\*h = Hinterschliff pro mm  
\*h = chamfer relief per mm

Nach dem Schärfen sollten Gewindebohrer mit Hilfe einer Drahtbürste entgratet werden. Wichtig ist, dass die Bewegung vom Schneidrücken zur Schneide hin ausgeführt wird.

*After grinding it is recommended to deburr the tap with means of a wire brush. It is important that the movement is always executed from the back to the cutting edge.*





# Werkstoffe

## *Materials*

Diese Tabelle enthält eine Auswahl von Werkstoffen mit Angabe der für die Zerspanung wichtigen Werkstoffeigenschaften im internationalen Vergleich. Die Daten wurden mit größter Sorgfalt aus unterschiedlichen Quellen zusammengetragen. Für den Inhalt können wir keine Gewähr übernehmen.

Innerhalb der Werkstoffgruppen sind die Werkstoffe nach der deutschen Werkstoff-Nr. sortiert. Die Zerspanungsgruppe ist eine interne Kennzahl und dient der Verbindung zur Anwendungstabelle auf den Seiten 13-18.

*This table contains a choice of materials with characteristics, that are important for the cutting process, in international comparison. The data was assembled with great care. The contents is without obligation.*

*Within the „Groups of Materials”, the materials are sorted to the German material code. The „Machinability Group” is an internal number to connect this list to the „Selector Chart” on pages 13-18.*

Materialgruppen Group of materials	Werkstoffe Materials		Zerspanungsgruppe Machinability-group	Werkstoff-Nr. German material code	DIN Bezeichnung DIN Symbol	Name	Zugfest min N(mm <sup>2</sup> ) Tensile strength min	Zugfest max N(mm <sup>2</sup> ) Tensile strength max	Bruchdehnung Elongation min. %	Bruchdehnung Elongation max. %	Glühhärt Annealing hardness
<b>1</b>	<b>Stahl</b> <i>Steel</i>										
<b>1.1</b>	<b>Baustähle</b> <i>General structural steel</i>										
	<b>1.1.1</b>	1.0035	St33				290	510	16	18	
	<b>1.1.0</b>	1.0036	USt37-2				320	470	21	26	
	<b>1.1.0</b>	1.0037	St37-2				320	470	21	26	
	<b>1.1.0</b>	1.0038	RSt37-2				320	470	21	26	
	<b>1.1.1</b>	1.0040	UST42-2				410	500			
	<b>1.1.1</b>	1.0044	St44-2				380	560	17	22	
	<b>1.1.1</b>	1.0050	St50-2				440	610	14	20	
	<b>1.1.1</b>	1.0060	St60-2				540	710	10	16	
	<b>1.1.2</b>	1.0070	St70-2				640	830	6	11	
	<b>1.1.0</b>	1.0114	St37-3U				320	470	21	26	
	<b>1.1.0</b>	1.0116	St37-3N				320	470	21	26	
	<b>1.1.0</b>	1.0123	Q-St37-3				320	470	21	24	
	<b>1.1.1</b>	1.0143	St44-3U				380	560	17	22	
	<b>1.1.1</b>	1.0144	St44-3N				380	560	17	22	
	<b>1.1.0</b>	1.0303	Q-St32-3				340	470			
	<b>1.1.1</b>	1.0482	19Mn5				410	530	23	23	
	<b>1.1.1</b>	1.0553	St52-3U				450	630	17	22	
	<b>1.1.1</b>	1.0570	St52-3N				450	630	17	22	
	<b>1.1.0</b>	1.1013	RFe100		Magnetweicheisen		250	400			
	<b>1.1.0</b>	1.1014	RFe80		Magnetweicheisen		250	400			
	<b>1.1.0</b>	1.1015	RFe60		Magnetweicheisen		250	400			
	<b>1.1.1</b>	1.7219	26CrMo4				590	740	18	18	
<b>1.2</b>	<b>Automatenstähle</b> <i>Free cutting steel</i>										
	<b>1.2.1</b>	1.0710	15S10				360	600			
	<b>1.2.1</b>	1.0711	9S20				460	710	9	9	
	<b>1.2.1</b>	1.0715	9SMn28				380	570	8	8	
	<b>1.2.1</b>	1.0718	9SMnPb28				410	760	6	10	
	<b>1.2.1</b>	1.0721	10S20				390	740	7	11	
	<b>1.2.1</b>	1.0722	10SPb20				360	740	7	11	
	<b>1.2.1</b>	1.0723	15S20				410	760	6	10	
	<b>1.2.2</b>	1.0726	35S20				510	830	6	10	
	<b>1.2.2</b>	1.0727	45S20				610	930	5	9	
	<b>1.2.2</b>	1.0728	60S20				710	1030	5	9	
	<b>1.2.1</b>	1.0736	9SMn36				430	780	6	10	
	<b>1.2.1</b>	1.0737	9SMnPb36				430	780	6	10	
	<b>1.2.2</b>	1.0756	35SPb20				510	830	6	10	
	<b>1.2.2</b>	1.0757	45SPb20				610	930	5	9	
	<b>1.2.2</b>	1.0758	60SPb20				710	1030	5	9	
<b>1.3</b>	<b>Kaltfließpressstähle</b> <i>Steel for cold extrusion</i>										
	<b>1.3.1</b>	1.1132	Cq15				500	650	20	22	
	<b>1.3.1</b>	1.1152	Cq22				500	650	20	22	
	<b>1.3.1</b>	1.1172	Cq35				600	750	17	20	
	<b>1.3.1</b>	1.1192	Cq45				650	800	14	17	
<b>1.4</b>	<b>Einsatzstähle</b> <i>Case hardening steel</i>										
	<b>1.4.1</b>	1.0301	C10				490	640	13	16	
	<b>1.4.1</b>	1.0302	C10Pb				490	640	13	16	
	<b>1.4.1</b>	1.0401	C15				590	780	12	14	
	<b>1.4.1</b>	1.0403	C15Pb				590	780	12	14	
	<b>1.4.1</b>	1.1121	Ck10				490	640	13	16	
	<b>1.4.1</b>	1.1140	Cm15				590	780	12	14	
	<b>1.4.1</b>	1.1141	Ck15				590	780	12	14	
	<b>1.4.2</b>	1.5732	14NiCr10				880	1180	9	11	

EU	ISO	GB (BS)	USA (AISI/ASTM)	Italy (UNI)	France (AFNOR)	Sweden (SS)	Spain (UNE)	Japan (JIS)
----	-----	---------	-----------------	-------------	----------------	-------------	-------------	-------------

S185	Fe310-0	Fe310-0	A283 Grade A	Fe310-0	A33	1300-00	A310	
S235 JRG1	Fe360B	Fe360BF4	A283 Grade C	Fe360BFU	E24-2	1311-00	A360BNE	
S235JR	Fe360B	Fe360B	A283 Grade C	Fe360B	E24-2	1311-00	A360BN	
S235JRG2	Fe360C	40B	A283 Grade C	F360BFN	E24-2NE	1312-00	A360BNE	
S275JR	Fe430B	43B	A283 Grade D	F430B	E28-2	A430B	A430B	SM400B
E295	Fe490	50B	A572 Grade 50	Fe490-2	A50-2	2172-00	Fe490-2	SS490
E335	Fe590	55C	A572 Grade 65	Fe590-2	A60-2	Fe590-2	Fe590-2	SM570
E360	Fe690	Fe690-2		Fe690-2	A70-2	Fe690-2	Fe690-2	
S235JO	Fe360C	40C		Fe360C	E24-3	1312-00	A360C	
S235J2G3	Fe360D	40D	A573 Grade 58	Fe360D1	E24-4	Fe360D1	A360D	
S275JO	Fe430C	43C	A572 Grade 42	Fe430C	E28-3	1412-00	A430C	SM400C
S275J2G3	Fe430D	43D	A572 Grade 42	Fe430D1	E28-4	1414-00	A430D	
				CB4FU				SWRCH6R
							SG365	
S355JO	Fe510C	50C	A572 Grade 50	Fe510C	E36-3	2132-01	A510C	SM520B
S355J2G3	Fe510D	50D	A572 Grade 50	Fe510D1	E36-4	2134-01	A510D	SM520C

10S22	9S20	170M15	1212	CF10S20		1922-04	F2111	SUM12
11SMn28	11SMn28	080M15	1213	CF9SMn28	S250	1912-04	F2111	SUM22
11SMnPb28	11SMnPb28		12L14	CF9SMnPb28	S250Pb	1914-04	F2112	SUM22L
10S20	10S20	210M15	1102	CF10S20	13MF4	1912-04	F2121	
10SPb20	10SPb20		1108	CF10SPb20	CC10Pb	1914-04	F2122	SUM12
		210A15				1922	F210.F	SUM32
35S20	30S20	212M36	1141	CF35SMn10	35MF6	1957-03	F2131	SUM41
45S20	46S20	216M44	1146	CF44SMn28	45MF61	1973-03	F2133	SUM42
60S20			1151					
12SMn35	12SMn35	240M07	1215	CF9SMn36	S300	1912-04	F2113	SUM25
12SMnPb35	12SMnPb35		12L14	CF9MnPb36	S300Pb	1914-04	F2114	SUM24L

				C20				
				3CD45	XC45		F1145	

		045M10	1010	C10	XC10		F151	S10C
		080M15	1015	C15	XC12	1350	F111	S15C
2C10	C10	045M10	1010	C10	XC10	1265	F1510	S10C
2C15	C15E4	080M15	1015	C15	XC12	1370-04	F1511	S15C
		655M13	3415	16NiCr11	12NC15		F1540	SNC21H

Materialgruppen Group of materials	Werkstoffe Materials		Zerspanungsgruppe Machinability-group	Werkstoff-Nr. German material code	DIN Bezeichnung DIN Symbol	Name	Zugfest min N(mm <sup>2</sup> ) Tensile strength min	Zugfest max N(mm <sup>2</sup> ) Tensile strength max	Bruchdehnung Elongation min. %	Bruchdehnung Elongation max. %	Glühhärt Annealing hardness
1.4 Einsatzstähle <i>Case hardening steel</i>	1.4.3	1.5752		14NiCr14			930	1230	9	10	
	1.4.3	1.5860		14NiCr18			1180	1370	7	7	
	1.4.2	1.5919		15CrNi6			780	1060	8	10	
	1.4.3	1.5920		18CrNi8			1180	1420	7	8	
	1.4.2	1.6523		21NiCrMo2			780	1080	9	11	
	1.4.3	1.6587		17CrNiMo6			1080	1320	7	8	
	1.4.1	1.7012		13Cr2			540	690	14	17	
	1.4.2	1.7015		15Cr3			690	880	10	11	
	1.4.2	1.7016		17Cr3			700	900	10	11	
	1.4.2	1.7131		16MnCr5			780	1080	9	11	
	1.4.2	1.7139		16MnCrS5			780	1080	9	11	
	1.4.3	1.7147		20MnCr5			980	1270	7	10	
	1.4.3	1.7149		20MnCrS5			980	1270	7	10	
	1.4.2	1.7262		15CrMo5			780	1080	9	11	
	1.4.3	1.7264		20CrMo5			980	1270	7	10	
	1.4.3	1.7271		23CrMoB3-3			1080	1370	7	8	
	1.4.2	1.7311		20CrMoS2			780	1080	9	10	
	1.4.2	1.7321		20MoCr4			780	1080	9	10	
	1.4.2	1.7323		20MoCrS4			780	1080	9	10	
	1.4.3	1.7325		25MoCr4			980	1270	7	8	
1.4.3	1.7326		25MoCrS4			980	1270	7	8		
1.5 Nitrierstähle <i>Nitriding steel</i>	1.5.1	1.8504		34CrAl6			780	780	14	14	
	1.5.2	1.8506		34CrAlS5			930	930	12	12	
	1.5.2	1.8507		34CrAlMo5			1100	1200	14	14	
	1.5.2	1.8509		41CrAlMo7			980	980	12	12	
	1.5.2	1.8515		31CrMo12			1100	1130	10	12	
	1.5.3	1.8519		31CrMoV9			1100	1230	9	12	
	1.5.2	1.8521		15CrMoV5-9			1050	1100	10	12	
	1.5.3	1.8523		39CrMoV139			1080	1420	8	8	
	1.5.3	1.8550		34CrAlNi7			1000	1470	12	13	
1.6 Vergütungsstähle <i>Heat-treatable steel</i>	1.6.1	1.0402		C22			470	650	20	22	
	1.6.1	1.0406		C25			500	700	19	21	
	1.6.1	1.0501		C35			550	780	17	20	
	1.6.2	1.0503		C45			630	850	14	17	
	1.6.1	1.0511		C40			600	800	16	19	
	1.6.1	1.0528		C30			500	750	18	21	
	1.6.2	1.0535		C35			700	950	12	15	
	1.6.2	1.0540		C50			650	900	13	16	
	1.6.2	1.0601		C60			750	1000	11	14	
	1.6.1	1.1133		20Mn5			490	690	18	22	
	1.6.1	1.1151		C22E			470	650	20	22	
	1.6.2	1.1157		40Mn4			690	1080	12	15	
	1.6.1	1.1158		C25E			500	700	19	21	
	1.6.2	1.1165		30Mn5			640	930	14	16	
	1.6.2	1.1167		36Mn5			640	1080	9	15	
	1.6.2	1.1170		28Mn6			650	950	13	16	
	1.6.1	1.1178		C30E/Ck30			500	750	18	21	
	1.6.1	1.1181		C35E/Ck35			550	780	17	20	
	1.6.1	1.1186		C40E/Ck40			600	800	16	19	
	1.6.2	1.1191		C45E/Ck45			630	850	14	17	
	1.6.2	1.1203		C55E/Ck55			700	950	12	15	
	1.6.2	1.1206		C50E/Ck50			650	900	13	16	

EU	ISO	GB (BS)	USA (AISI/ASTM)	Italy (UNI)	France (AFNOR)	Sweden (SS)	Spain (UNE)	Japan (JIS)
		655M13	3310		12NC15			SNC22H
14CrNi6		815M17	4320		16NC6	2512-03	F1581	SNC15
		822M17		16NiCrMo12	20NC6		F1525	SNCM616
		805M20	8620	20NiCrMo2	20NCD2	2506	F1522	SNCM220
17CrNiMo7	17NiCrMo6	820M17		18NiCrMo12	18NCD6	2523-03	F1560	SNCM815
		523M15	5015		12C3			SCr415
15Cr2	C16E4	523M15	5615					
16MnCr5	16MnCr5	527M17	5115	16MnCr5	16MC5	2511-03	F1516	
	18CrMo4		5120	20MnCr5	20MC5	2523-03	F1523	SMnC420
					15CD4	2216	F1551	SCM415(H)
					18CD4		F1559	SCM421
					18CD4		F1559	SCM421
20MoCr4		805M20	8620	16NiCrMo2	18CD4	2506-03	F1523	SNCM220

33CrAlMo5	33CrAlMo54	905M31	A355/D	34CrAlMo7	30CAD6.12		F1741	
41CrAlMo7	41CrAlMo7	905M39	A355/A	41CrAlMo7	40CAD6.12	2940-04/03	F1740	
31CrMo12	31CrMo12	722M24		31CrMo12	30CD12	2240-05/04	F1721	
39CrMoV13		897M39		36CrMoV12				
			A355/C		40CAD612			

		1C22	1020	1C22	1C22	1C22	1C22	
	C25	1C25	1025	1C25	1C25	1C25	1C25	
	C35	1C35	1035	1C35	1C35	1C35	1C35	
	C45	1C45	1045	1C45	1C45	1C45	1C45	
	C40	1C40	1040	1C40	1C40	1C40	1C40	
	C30	1C30	1030	1C30	1C30	1C30	1C30	
	C35	1C35	1035	1C35	1C35	1C35	1C35	
	C50	1C50	1050	1C50	1C50	1C50	1C50	
	C60	1C60	1060	1C60	1C60	1C60	1C60	
		120M19	1022	G22Mn3			20Mn6	G22Mn3
		2C22		2C22	2C22	2C22	2C22	S22C
		150M36	1039		35M5			
		2C25	1025	2C25	2C25	2C25	2C25	S25C
		120M36	1330				30Mn5	SMn433H
			1335		40M5	2120	30Mn6	SMn438
	28Mn6	28Mn6	1330	28Mn6	28Mn6	28Mn6	28Mn6	SMn433
	C30E4	2C30		2C30	2C30	2C30	2C30	S30C
	C35E4	2C35	1035	2C35	2C35	2C35	2C35	S35C
	C40E4	2C40	1040	2C40	2C40	2C40	2C40	S40C
	C45E4	2C45	1045	2C45	2C45	2C45	2C45	S45C
	C55E4	2C55	1055	2C55	2C55	2C55	2C55	S55C
	C50E4	2C50	1050	2C50	2C50	2C50	2C50	S50C



Materialgruppen Group of materials	Werkstoffe Materials	Zerspanungsgruppe Machinability-group	Werkstoff-Nr. German material code	DIN Bezeichnung DIN Symbol	Name	Zugfest min N(mm <sup>2</sup> ) Tensile strength min	Zugfest max N(mm <sup>2</sup> ) Tensile strength max	Bruchdehnung Elongation min. %	Bruchdehnung Elongation max. %	Glühhärt Annealing hardness
1.6	Vergütungsstähle Heat-treatable steel	1.6.2	1.1221	C60E/Ck60		750	1000	11	14	
		1.6.3	1.1273	90Mn4		1670	1670	5	5	
		1.6.2	1.3401	X120Mn12		780	1130	40	45	
		1.6.2	1.3553	X82WMoCrV6-5-4	Wälzlagerstahl	800	1000			300
		1.6.2	1.3561	44Cr2		690	1080	12	15	
		1.6.3	1.3563	43CrMo4		780	1270	10	13	
		1.6.3	1.3565	48CrMo4		830	1270	9	13	
		1.6.2	1.5120	GS-38MnSi4		640	1130	11	14	
		1.6.3	1.5121	46MnSi4		640	1230	11	15	
		1.6.2	1.5122	37MnSi5		780	1180	11	14	
		1.6.2	1.5131	50MnSi4		740	990	11	13	
		1.6.2	1.5141	53MnSi4		690	1030	12	15	
		1.6.3	1.5223	42MnV7		880	1270	10	12	
		1.6.2	1.5710	36NiCr6		690	1180	11	15	
		1.6.2	1.5736	36NiCr10		740	1180	10	14	
		1.6.2	1.5755	31NiCr14		780	1080	11	13	
		1.6.3	1.5864	35NiCr18		1080	1470	7	9	
		1.6.3	1.6511	36CrNiMo4		800	1300	10	13	
		1.6.2	1.6513	28NiCrMo4		740	930	13	13	
		1.6.3	1.6580	30CrNiMo8		1000	1450	9	10	
		1.6.3	1.6582	34CrNiMo6		900	1400	9	12	
		1.6.1	1.6755	22NiMoCr4-7		560	710	19	19	
		1.6.2	1.6932	28NiCrMoV8-5		800	950	14	14	
		1.6.3	1.6956	33NiCrMo14-5		1130	1470	7	7	
		1.6.2	1.7003	38Cr2		600	950	14	17	
		1.6.2	1.7006	46Cr2		650	1100	12	15	
		1.6.2	1.7020	32Cr2		500	850	15	17	
		1.6.2	1.7023	38CrS2		900	1100			
		1.6.2	1.7025	46CrS2		900	1100			
		1.6.2	1.7030	28Cr4		650	1000	12	15	
		1.6.2	1.7033	34Cr4		700	1100	12	15	
		1.6.2	1.7034	37Cr4		750	1150	11	14	
		1.6.2	1.7035	41Cr4		800	1200	11	14	
		1.6.2	1.7036	28CrS4		750	1100			
		1.6.2	1.7037	34 CrS4		900	1100			
		1.6.2	1.7038	37CrS4		900	1100			
		1.6.2	1.7039	41CrS4		900	1100			
		1.6.2	1.7213	25CrMoS4		650	950			
		1.6.2	1.7218	25CrMo4		700	1100	12	15	
		1.6.2	1.7220	34CrMo4		800	1200	11	15	
		1.6.3	1.7225	42CrMo4		900	1300	10	13	
		1.6.2	1.7226	34CrMoS4		900	1100			
		1.6.2	1.7227	42CrMoS4		900	1100			
		1.6.3	1.7228	50CrMo4		850	1300	9	13	
		1.6.3	1.7361	32CrMo12		980	1420	9	11	
		1.6.3	1.7561	42CrV6		740	1270	10	14	
		1.6.3	1.7707	30CrMoV9		1000	1450	9	11	
1.6.3	1.7735	14CrMoV6-9		700	1300	10	12			
1.6.3	1.8159	51CrV4		850	1300	9	13			
1.6.3	1.8161	58CrV4		980	1570	7	12			
1.7	Werkzeugstähle Tool steel	1.7	1.1520	C70W1						190
		1.7	1.1525	C80W1						190
		1.7	1.1545	C105W1						190

EU	ISO	GB (BS)	USA (AISI/ASTM)	Italy (UNI)	France (AFNOR)	Sweden (SS)	Spain (UNE)	Japan (JIS)
	C604E	2C60	1060	2C60	2C60	2C60	2C60	S58C
		Z120M12		G-X120Mn12	Z120M12		X120Mn12	
X80WMoCrV6				X82WMoV65	Z85WDCV6			
		CLA1-GradeC	A732Grade3A					SCC3
		640A35	3135		35NC6			SNC236
			3435	35NiCr9				SNC631
		653M31			18NC13		F123	SNC836
	36CrNiMo4	36CrNiMo4	9840	36CrNiMo4	36CrNiMo4	36CrNiMo4	36CrNiMo4	SNCM439
	30CrNiMo8	30CrNiMo8		30CrNiMo8	30CrNiMo8	30CrNiMo8	30CrNiMo8	SNCM630
	34CrNiMo6	34CrNiMo6	4340	34CrNiMo6	34CrNiMo6	34CrNiMo6	34CrNiMo6	SNCM447
		38Cr2		38Cr2	38Cr2	38Cr2	38Cr2	SMn438
		46Cr2	5045	46Cr2	46Cr2	46Cr2	46Cr2	SMn443
		38CrS2		38CrS2	38CrS2	38CrS2	38CrS2	
		46CrS2		46CrS2	46CrS2	46CrS2	46CrS2	
		530A30	5130		30CD4			
	34Cr4	530A32	5132	34Cr4	34Cr4	34Cr4	34Cr4	SCr430
	37Cr4	37Cr4	5135	37Cr4	37Cr4	37Cr4	37Cr4	SCr435
	41Cr4	41Cr4	5140	41Cr4	41Cr4	41Cr4	41Cr4	SCr440
		28CrS4		28CrS4	28CrS4	28CrS4	28CrS4	
	34CrS4	34CrS4		34CrS4	34CrS4	34CrS4	34CrS4	3SCr3
	37CrS4	37CrS4		37CrS4	37CrS4	37CrS4	37CrS4	
	41CrS4	41CrS4		41CrS4	41CrS4	41CrS4	41CrS4	
	25CrMoS4	25CrMoS4		25CrMoS4	25CrMoS4	25CrMoS4	25CrMoS4	
	25CrMo4	25CrMo4	4130	25CrMo4	25CrMo4	25CrMo4	25CrMo4	SCM430
	34CrMo4	34CrMo4	4137	34CrMo4	34CrMo4	34CrMo4	34CrMo4	SCM435
	42CrMo4	42CrMo4	4140	42CrMo4	42CrMo4	42CrMo4	42CrMo4	SCM400
	34CrMoS4	34CrMoS4		34CrMoS4	34CrMoS4	34CrMoS4	34CrMoS4	
	42CrMoS4	42CrMoS4		42CrMoS4	42CrMoS4	42CrMoS4	42CrMoS4	
	50CrMo4	50CrMo4	4150	50CrMo4	50CrMo4	50CrMo4	50CrMo4	
		722M24		32CrMo12	30CD12			
	51CrV4	735A50	6150	51CrV4	51CrV4	51CrV4	51CrV4	SUP20
			W108	C80KU	Y190		F513	
			W110	C98KU	Y105	1880	F515	

Materialgruppen Group of materials	Werkstoffe Materials	Zerspanungsgruppe Machinability-group	Werkstoff-Nr. German material code	DIN Bezeichnung DIN Symbol	Name	Zugfest min N(mm <sup>2</sup> ) Tensile strength min	Zugfest max N(mm <sup>2</sup> ) Tensile strength max	Bruchdehnung Elongation min. %	Bruchdehnung Elongation max. %	Glühhärtigkeit Annealing hardness
1.7	Werkzeugstähle Tool steel	1.7	1.1554	C110W						195
		1.7	1.1563	C125W						210
		1.7	1.1573	C135W						230
		1.7	1.1620	C70W2						190
		1.7	1.1625	C80W2						190
		1.7	1.1645	C105W2						190
		1.7	1.1730	C45W						190
		1.7	1.1740	C60W						207
		1.7	1.1744	C67W						217
		1.7	1.1750	C75W						217
		1.7	1.1820	C55W						170
		1.7	1.1830	C85W						225
		1.7	1.2002	125Cr1						200
		1.7	1.2003	75Cr1						200
		1.7	1.2004	85Cr1						210
		1.7	1.2008	140Cr3						235
		1.7	1.2056	90Cr3						210
		1.7	1.2057	105Cr4						210
		1.7	1.2063	145Cr6						225
		1.7	1.2067	100Cr6						230
		1.7	1.2080	X210Cr12						250
		1.7	1.2082	X21Cr13						200
		1.7	1.2083	X42Cr13						225
		1.7	1.2085	X33CrS16						230
		1.7	1.2101	62SiMnCr4						225
		1.7	1.2103	58SiCr8						230
		1.7	1.2108	90CrSi5						230
		1.7	1.2109	125CrSi5						230
		1.7	1.2127	105MnCr4						220
		1.7	1.2129	200CrMn8						250
		1.7	1.2162	21MnCr5						215
		1.7	1.2201	X165CrV12						230
		1.7	1.2206	140CrV1						210
		1.7	1.2208	31CrV3						220
		1.7	1.2210	115CrV3						220
		1.7	1.2235	80CrV2						250
		1.7	1.2241	51CrV4						225
		1.7	1.2242	59CrV4						225
		1.7	1.2243	61CrSiV5						220
		1.7	1.2248	38SiCrV6						215
		1.7	1.2249	45SiCrV6						220
		1.7	1.2303	100CrMo5						230
		1.7	1.2305	102CrMo6						230
		1.7	1.2307	29CrMoV9						240
		1.7	1.2309	65MnCrMo4						230
		1.7	1.2311	40CrMnMo7						230
		1.7	1.2312	40CrMnMoS8-6						230
		1.7	1.2313	21CrMo10						200
		1.7	1.2316	X36CrMo17						250
		1.7	1.2319	X64CrMo14						240
1.7	1.2323	48CrMoV6-7						215		
1.7	1.2327	86CrMoV7						250		
1.7	1.2328	45CrMoV7						250		
1.7	1.2341	6CrMo15-5						110		

EU	ISO	GB (BS)	USA (AISI/ASTM)	Italy (UNI)	France (AFNOR)	Sweden (SS)	Spain (UNE)	Japan (JIS)
		BW1B	W1	C80KU	Y180			SKC3-6
				C100KU	Y1105			SK3
					Y342			
					Y355			SK7
		BW1A	W1					
						14 1665		
					Y390			SK5
			W5	2955 L4B	XC85		F120K	
					Y75C			
							F120J	SUJ1
		BL3	L3		Y100C6			
		BD3	D3	X210Cr12KU	Z200C12			SKC1
				X41Cr13KU	Z40C14			SUS420J2
					Y45SCD6			
			L5					SUJ3
					20NC5			SCR420H
			D2	2955 DTC-ARW				
					Y(2)140C		F520K	
			L2	107CrV3KU	100C3			
			L2					SKC11
			L7				F520F	
				UC12	35CMD7			
				X38CrMo16 1KU	Z40CD16			
			P20					

Materialgruppen Group of materials	Werkstoffe Materials	Zerspanungsgruppe Machinability-group	Werkstoff-Nr. German material code	DIN Bezeichnung DIN Symbol	Name	Zugfest min N(mm <sup>2</sup> ) Tensile strength min	Zugfest max N(mm <sup>2</sup> ) Tensile strength max	Bruchdehnung Elongation min. %	Bruchdehnung Elongation max. %	Glühhärtigkeit Annealing hardness
1.7	Werkzeugstähle Tool steel	1.7	1.2342	X35CrMoV5-1-1						230
		1.7	1.2343	X38CrMoV5-1						235
		1.7	1.2344	X40CrMoV5-1						235
		1.7	1.2353	27CrMoV6-12						223
		1.7	1.2360	X48CrMoV8-1-1						240
		1.7	1.2361	X91CrMoV18						265
		1.7	1.2362	X63CrMoV5-1						225
		1.7	1.2363	X100CrMoV5-1						230
		1.7	1.2365	X32CrMoV33						230
		1.7	1.2367	X38CrMoV5-3						235
		1.7	1.2369	81MoCrV42-16						250
		1.7	1.2376	X96CrMoV12						250
		1.7	1.2378	X220CrVMo12-2						255
		1.7	1.2379	X155CrVMo12-1						250
		1.7	1.2381	73MoV5-2						280
		1.7	1.2414	120W4						220
		1.7	1.2419	105WCr6						230
		1.7	1.2436	X210CrW12						255
		1.7	1.2442	115W8						220
		1.7	1.2453	X130W5						225
		1.7	1.2510	100MnCrW4						230
		1.7	1.2516	120WV4						230
		1.7	1.2519	110WCrV5						225
		1.7	1.2542	45WCrV7						225
		1.7	1.2550	60WCrV7						225
		1.7	1.2552	80WCrV8						230
		1.7	1.2562	142WV13						240
		1.7	1.2564	30WCrV15-1						230
		1.7	1.2567	X30WCrV53						240
		1.7	1.2581	X30WCrV9-3						240
		1.7	1.2601	X165CrMoV12						255
		1.7	1.2603	45CrVMoW5-8						240
		1.7	1.2604	73WCrMoV2-2						225
		1.7	1.2606	X37CrMoW5-1						230
		1.7	1.2622	X60WCrMoV9-4						270
		1.7	1.2631	X50CrMoW9-1-1						230
		1.7	1.2662	X30WCrCoV9-3						250
		1.7	1.2678	X45CoCrWV5-5-5						260
		1.7	1.2703	74NiCr2						248
		1.7	1.2709	X3NiCoMoTi18-9-5						270
		1.7	1.2710	45NiCr6						240
		1.7	1.2711	54NiCrMoV6						225
		1.7	1.2713	55NiCrMoV6						240
		1.7	1.2714	56NiCrMoV7						250
		1.7	1.2718	55NiCr10						250
		1.7	1.2721	50NiCr13						250
		1.7	1.2726	26NiCrMoV5						240
		1.7	1.2731	X50NiCrWV13-13						
		1.7	1.2735	15NiCr14						200
		1.7	1.2737	28NiCrV5						240
1.7	1.2738	40CrMnNiMo8-6-4						235		
1.7	1.2740	28NiCrMoV10						240		
1.7	1.2743	60NiCrMoV12-4						235		
1.7	1.2744	57NiCrMoV7-7						250		

EU	ISO	GB (BS)	USA (AISI/ASTM)	Italy (UNI)	France (AFNOR)	Sweden (SS)	Spain (UNE)	Japan (JIS)
		BH11	H11	X37CrMoV51KU	Z38CDV5			SKD6
		BH13	H13	X35CrMoV05KU	Z40CDV5	2242		SKD61
		BA2	A2	X100CrMoV51KU	Z100CDV5	2260		SKD12
		BH10	H10	30CrMoV12.27KU	32DCV28			SKD7
					Y80DCV 42.16			
			D7		Z230CVA12.4			
		BD2	D2	X155CrVMo121KU	Z160CDV12			SKD11
				VAL7				
				10WCr5KU	105WC13			SKS31
				X215CrW12 1KU		2312		SKD2
		BO1	O1	95MnWCr5KU	90MWCV5	2140		SKS3
		BF1		110W4KU	110MC20			
					105WC13			
		BS1	S1	45WCrV8KU		2710		
				55WCrV8KU	SSWC20			
			F2					SKST
				X30WCrV5.3KU	Z32WCV5			SKD4
		BH21	H21	X28W09KU	Z30WCV9			SKD5
				X165CrMoW12KU		2310		
		BH19	H19					SKD8
					55NCDV6			
			L6		55NCDV7			SKT4
					10NC12			SNC22



Materialgruppen Group of materials	Werkstoffe Materials		Zerspanungsgruppe Machinability-group	Werkstoff-Nr. German material code	DIN Bezeichnung DIN Symbol	Name	Zugfest min N(mm <sup>2</sup> ) Tensile strength min	Zugfest max N(mm <sup>2</sup> ) Tensile strength max	Bruchdehnung Elongation min. %	Bruchdehnung Elongation max. %	Glühhärt HB Annealing hardness
1.7 Werkzeugstähle <i>Tool steel</i>	1.7	1.2745		15NiCr18							250
	1.7	1.2746		45NiCrMoV16-6							295
	1.7	1.2747		28NiMo17							285
	1.7	1.2762		75CrMoNiW6-7							210
	1.7	1.2764		X9NiCrMo4							255
	1.7	1.2766		35NiCrMo16							260
	1.7	1.2767		X45NiCrMo4							260
	1.7	1.2779		X6NiCrTi2615							250
	1.7	1.2782		X16CrNiSi25-20							
	1.7	1.2786		X13NiCrSi36-16							
	1.7	1.2787		X23CrNi17							
	1.7	1.2823		70Si7							240
	1.7	1.2826		60MnSiCr4							220
	1.7	1.2833		100V1							230
	1.7	1.2838		145V33							230
	1.7	1.2842		90MnCrV8							220
	1.7	1.2880		X165CrCoMo12							260
	1.7	1.2884		X210CrCoW12							260
	1.7	1.2885		X32CrMoCoV3-3-3							230
	1.7	1.2886		X15CrCoMoV10-10-5							320
1.7	1.2888		X20CoCrWMo10-9							320	
1.7	1.2889		X45CoCrMoV5-5-3							240	
1.8 Schnellarbeitsstähle <i>High speed steel</i>	1.8	1.3202		S12-1-4-5							300
	1.8	1.3207		S10-4-3-10							300
	1.8	1.3243		S6-5-2-5							300
	1.8	1.3245		S6-5-2-5S							300
	1.8	1.3246		S7-4-2-5							300
	1.8	1.3247		S2-10-1-8							300
	1.8	1.3249		S2-9-2-8							300
	1.8	1.3255		S18-1-2-5							300
	1.8	1.3257		S18-1-2-15							300
	1.8	1.3265		S18-1-2-10							300
	1.8	1.3302		S12-1-4							300
	1.8	1.3318		S12-1-2							280
	1.8	1.3333		S5-3-2							280
	1.8	1.3341		S6-5-2-S							300
	1.8	1.3342		SC6-5-2							280
	1.8	1.3343		S6-5-2							280
	1.8	1.3344		S6-5-3							280
	1.8	1.3346		S2-9-1							280
	1.8	1.3348		S2-9-2							280
	1.8	1.3355		S18-0-1							300
1.8	1.3392		S1-5-2							270	
1.9 Nichtrostende Stähle 1.9.4 ferritisch/martensitisch <i>Stainless steel</i> 1.9.4 ferritic/martensitic	1.9.4	1.4000		X6Cr13			400	600	20	20	
	1.9.4	1.4001		X7Cr14			400	600	20	20	
	1.9.4	1.4002		X6CrAl13			400	600	20	20	
	1.9.4	1.4003		X2CrNi12			450	600	18	20	
	1.9.4	1.4005		X12CrS13			650	850	12	12	
	1.9.4	1.4006		X12Cr13			590	780	16	16	
	1.9.4	1.4008		GX8CrNi13			590	780	15	15	
	1.9.4	1.4016		X6Cr17			400	630	18	20	
1.9.4	1.4021		X20Cr13			750	950	13	13		

EU	ISO	GB (BS)	USA (AISI/ASTM)	Italy (UNI)	France (AFNOR)	Sweden (SS)	Spain (UNE)	Japan (JIS)
			P6		10NC12			SKC31
				42NiCrMo15.7	Y35NCD16			
		BS5	S5					
		BW2	W210	102V2KU	Y1105V			SKS43
		BO2	O2	90MnVCr8KU	90MV8			
					Z169CKDV12.03			

		BT15	T15					
		BT42			Z130WKCDV			SKH57
				HS6-5-2-5	Z85WDKCV	2723		SKH55
			M41		Z110WKCDV			
		BM42	M42		Z110DKCWV			
		BM34	M34					
		BT4	T4		Z80WKCV			SKH3
		BT5	T5					SKH4A
			M3		Z90WDCV			
		BM2	M2		Z85WDCV	2722		SKH9
			M3 Class2		Z120WDCV			SKH52
		BM1	M1		Z85DVVV			
			M7		Z100DCWV	2782		
		BT1	T1		Z80WCV			

X6Cr13	Type 1	403S17	403	X6Cr13	Z6C13	2301	X6Cr13	SUS403
		403S17	410S	X6Cr13	Z3C14	2301	X12Cr13	SUS410S
	Type 2		405	X6CrAl13	Z6CA13		X6CrAl13	SUS405
		416S21	416	X12CrS13	Z12CF13	2380		SUS416
	Type 3	410S21	410	X12Cr13	Z12C13	2302	X12Cr13	SUS410
		410C21		GX12Cr13	Z12CN13M			SCS1
X8Cr17	Type 8	430S17	430	X8Cr17	Z8C17	2320	X6Cr17	SUS430
	Type 4	420S37	420	X20Cr13	Z20C13	2303	X20Cr13	SUS420J1

Materialgruppen Group of materials	Werkstoffe Materials	Zerspanungsgruppe Machinability-group	Werkstoff-Nr. German material code	DIN Bezeichnung DIN Symbol	Name	Zugfest min N(mm <sup>2</sup> ) Tensile strength min	Zugfest max N(mm <sup>2</sup> ) Tensile strength max	Bruchdehnung Elongation min. %	Bruchdehnung Elongation max. %	Glühhärt Annealing hardness
1.9	Nichtrostende Stähle 1.9.4 ferritisch/martensitisch Stainless steel 1.9.4 ferritic/martensitic	1.9.4	1.4024	X15Cr13		650	800	14	14	
		1.9.4	1.4027	GX20Cr14		590	790	12	12	
		1.9.4	1.4028	X30Cr13		850	1000			
		1.9.4	1.4031	X39Cr13		650	800			
		1.9.4	1.4034	X46Cr13		650	800			
		1.9.4	1.4037	X65Cr13		650	840			
		1.9.4	1.4057	X17CrNi16-2		800	950	12	14	
		1.9.4	1.4059	GX22CrNi17		780	980	4	4	
		1.9.4	1.4085	GX70Cr29		880	980			
		1.9.4	1.4086	GX120Cr29		880	1080			
		1.9.4	1.4104	X14CrMoS17	Automatenstahl	650	850	10	12	
		1.9.4	1.4105	X6CrMoS17	Automatenstahl	430	630	20	20	
		1.9.4	1.4109	X70CrMo15		800	900			
		1.9.4	1.4110	X55CrMo14		800	900			
		1.9.4	1.4111	X11XCrMoV15		800	900			
		1.9.4	1.4112	X90CrMoV18		800	900			
		1.9.4	1.4113	X6CrMo17-1		450	660	18	18	
		1.9.4	1.4116	X50CrMoV15		800	900			
		1.9.4	1.4117	X38CrMoV15		800	900			
		1.9.4	1.4120	X20CrMo13		750	900	14	14	
		1.9.4	1.4122	X39CrMo17-1		750	950	12	12	
		1.9.4	1.4125	X105CrMo17		800	1000			
		1.9.4	1.4136	GX70CrMo29-2		880	980			
		1.9.4	1.4138	GX120CrMo29-2		880	1080			
		1.9.4	1.4313	X3CrNiMo13-4		650	830	12	15	
		1.9.4	1.4313	X5CrNi13-4		900	1100	12	12	
		1.9.4	1.4340	GX40CrNi27-4		440	640			
		1.9.4	1.4347	GX8CrNiN26-7		590	790	20	20	
		1.9.4	1.4362	X2CrNiN23-4		600	830	25	25	
		1.9.4	1.4405	GX4CrNiMo16-5-1		760	960	15	15	
		1.9.4	1.4418	X4CrNiMo16-5-1		760	960			
		1.9.4	1.4460	X3CrNiMoN27-5-2	Duplex	620	880	20	20	
		1.9.4	1.4510	X3CrTi17		420	600	23	23	
		1.9.4	1.4511	X3CrNb17		420	600	23	23	
		1.9.4	1.4512	X2CrTi12		380	560	25	25	
		1.9.4	1.4520	X2CrTi17		450	700			
		1.9.4	1.4521	X2CrMoTi18-2		450	650	20	20	
		1.9.4	1.4535	X90CrCoMoV17						
		1.9.4	1.4542	X5CrNiCuNb16-4	17.4PH	1070	1270	10	10	
		1.9.4	1.4589	X5CrNiMoTi15-2		600	800			
1.9	Nichtrostende Stähle 1.9.5 austenitisch Stainless steel 1.9.5 austenitic	1.9.5	1.4301	X5CrNi18-10	V2A	500	750	45	45	
		1.9.5	1.4303	X4CrNi18-12		500	700	45	45	
		1.9.5	1.4305	X10CrNiS18-9	Automatenstahl	500	750	35	35	
		1.9.5	1.4306	X2CrNi19-11		520	670	45	45	
		1.9.5	1.4307	X2CrNi18-9		460	670	45	45	
		1.9.5	1.4308	GX5CrNi19-10		440	640	20	20	
		1.9.5	1.4310	X10CrNi18-8		500	950	40	40	
		1.9.5	1.4311	X2CrNi18-10		550	750	40	40	
		1.9.5	1.4312	GX10CrNi18-8		440	640	20	20	
		1.9.5	1.4318	X2CrNi18-7		630	850	35	45	
		1.9.5	1.4335	X1CrNi25-21		470	670	40	40	
		1.9.5	1.4361	X1CrNiSi18-15-4		530	730	30	40	
		1.9.5	1.4401	X5CrNiMo17-12-2		500	700	40	45	

EU	ISO	GB (BS)	USA (AISI/ASTM)	Italy (UNI)	France (AFNOR)	Sweden (SS)	Spain (UNE)	Japan (JIS)
		420S29						SUS410-J1
		420C29			Z20C13M			
X30Cr13	Type 5	420S37		X30Cr13	Z33C13	2304	X30Cr13	SUS420J2
X40Cr13	Type 6			X40Cr14	Z44C14	2304-03	X40Cr13	SUS420J2
X45Cr13	Type 6a	420S45		X40Cr13	Z40CM		X45Cr13	
	Type 9b	431S29	431	X16CrNi16	Z15CNI6.02	2321	X19CrNi172	SUS431
X14CrS17	Type 9a		430F	X10CrS17	Z10CH17	2383	X8CrS17	SUS430F
		434S17	434	X8CrMo17	Z8CD17.01	2325		SUS434
			440C	X105CrMo17	Z100CD17			SUS440C
		424C11	CA6NM	X6CrNi13.04	Z4CND13.4M	2385		SCS5
			S32304					
			329					SUS319J1
X8CrTi17	Type 8b		430Ti	X6CrTi17	Z8CT17		X5CrTi17	SUS430LX
				X6CrNb17	Z8CNb17			SUS430LX
		409S19	409	X6CrTi12	Z6CT12			SUH409
			630		Z5CNU174			

X5CrNi18-10	Type 11	304S15	304	X5CrNi18-10	Z7CN18.09	2332-02	X5CrNi18-10	SUS304
X8CrNi1812	Type 13		308	X8CrNi19.10	Z8CN18.12		X5CrNi18-12	
X10CrNiS189	Type 17	303S31	303	X10CrNiS18.09	Z10CNF18.09	2346	X10CrNiS189	SUS303
X2CrNi1810	Type 10	304S12	304L	X2CrNi18.11	Z3CN19.09	2333	X2CrNi19-10	SUS304L
		304C15			Z6CN18.10M			
		301S21		X12CrNi17.07	Z12CN17.07			
		304S62	304LN	X2CrNiN18.11	Z2CN18.10	2371		SUS304LN
X5CrNiMo17122	Type 20	316S31	316	X5CrNiMo17.12	Z7CND17.11.02	2347	X5CrNiMo17-12-02	SUS316

Materialgruppen Group of materials	Werkstoffe Materials	Zerspanungsgruppe Machinability-group	Werkstoff-Nr. German material code	DIN Bezeichnung DIN Symbol	Name	Zugfest min N(mm <sup>2</sup> ) Tensile strength min	Zugfest max N(mm <sup>2</sup> ) Tensile strength max	Bruchdehnung Elongation min. %	Bruchdehnung Elongation max. %	Glühhärt Annealing hardness
1.9	Nichtrostende Stähle 1.9.5 austenitisch Stainless steel 1.9.5 austenitic	1.9.5	1.4404	X2CrNiMo17-12-2		500	700	40	45	
		1.9.5	1.4406	X2CrNiMoN17-11-2		580	800	30	40	
		1.9.5	1.4408	GX5CrNiMo19-11-2		440	640	20	20	
		1.9.5	1.4429	X2CrNiMoN17-13-3		580	800	35	40	
		1.9.5	1.4435	X2CrNiMo18-14-3		500	700	40	45	
		1.9.5	1.4436	X3CrNiMo17-13-3		500	730	40	40	
		1.9.5	1.4437	GX6CrNiMo18-12		440	640	20	20	
		1.9.5	1.4438	X2CrNiMo18-15-4		500	700	30	40	
		1.9.5	1.4439	GX3CrNiMoN17-13-5		490	690	20	20	
		1.9.5	1.4439	X2CrNiMoN17-13-5		580	800	35	40	
		1.9.5	1.4446	GX2CrNiMoN17-13-4		490	640	20	20	
		1.9.5	1.4448	GX6CrNiMo17-13		440	640	20	20	
		1.9.5	1.4462	X2CrNiMoN22-5-3	Duplex	640	950	20	25	
		1.9.5	1.4463	GX6CrNiMo24-8-2		590	790	20	20	
		1.9.5	1.4464	GX40CrNiMo27-5		800	1000			
		1.9.5	1.4465	X1CrNiMoN25-25-2		540	740	40	40	
		1.9.5	1.4465	GX2CrNiMoN25-25-2		440	640	25	25	
		1.9.5	1.4466	X1CrNiMoN25-22-2		540	740	40	40	
		1.9.5	1.4468	GX3CrNiMoN26-6-3		650	850	22	22	
		1.9.5	1.4469	GX2CrNiMoN26-7-4		650	850	22	22	
		1.9.5	1.4501	X2CrNiMoCuWN25-7-4	Duplex	500	700			
		1.9.5	1.4505	X4NiCrMoCuNb20-18-2		490	740	40	40	
		1.9.5	1.4506	X5NiCrMoCuTi20-18		490	740	40	40	
		1.9.5	1.4515	GX3CrNiMoCuN26-6-3		650	850	22	22	
		1.9.5	1.4517	GX2CrNiMoCuN25-6-3-3		650	850	22	22	
		1.9.5	1.4529	X1NiCrMoCuN25-20-7		650	850	40	40	
		1.9.5	1.4531	GX2NiCrMoCuN20-18		440	640	20	20	
		1.9.5	1.4536	GX2NiCrMoCuN25-20		440	640	20	20	
		1.9.5	1.4539	X1NiCrMoCuN25-20-5		520	730	35	35	
		1.9.5	1.4540	GX4CrNiCuNb16-4		950	1035	9	9	
		1.9.5	1.4541	X6CrNiTi18-10		500	720	40	40	
		1.9.5	1.4550	X6CrNiNb18-10		500	740	40	40	
		1.9.5	1.4552	GX5CrNiNb19-11		440	640	20	20	
		1.9.5	1.4558	X2NiCrAlTi32-20		450	700	35	35	
		1.9.5	1.4561	X1CrNiMoTi18-13-2		490	690	40	40	
		1.9.5	1.4562	X1NiCrMoCu32-28-7		650	850	40	40	
		1.9.5	1.4563	X1NiCrMoCu31-27-4		500	750	30	35	
		1.9.5	1.4565	X2CrNiMnMoNbN25		800	950	35	35	
		1.9.5	1.4568	X7CrNiAl17-7	17.7PH	700	850			
		1.9.5	1.4569	GX2CrNiMnMoNNb21		570	800	20	20	
		1.9.5	1.4571	X6CrNiMoTi17-12-2	V4A	500	700	40	40	
		1.9.5	1.4573	X10CrNiMoTi18-12		490	740	40	40	
		1.9.5	1.4575	X1CrNiMoNb28-4-2		600	750	20	20	
		1.9.5	1.4577	X3CrNiMoTi25-25		490	740	40	40	
		1.9.5	1.4580	X6CrNiMoNb17-12-2		510	740	30	35	
		1.9.5	1.4581	GX5CrNiMoNb19-11-2		440	640	20	20	
		1.9.5	1.4582	X4CrNiMoNb25-7		640	900	25	25	
1.9.5	1.4583	GX10CrNiMoNb18-12		440	640	20	20			
1.9.5	1.4583	X10CrNiMoNb18-12		490	740	40	40			
1.9.5	1.4585	GX7CrNiMoCuNb18-18		440	640	15	15			
1.9.5	1.4586	X5NiCrMoCuNb22-18		540	740	30	30			

EU	ISO	GB (BS)	USA (AISI/ASTM)	Italy (UNI)	France (AFNOR)	Sweden (SS)	Spain (UNE)	Japan (JIS)
X2CrNiMo17132	Type 19	316S11	316L	X2CrNiMo17.12	Z3CND17.11.02	2348	X2CrNiMo17-13-02	SUS316L
		316S61	316LN	X2CrNiMoN17.12	Z2CND17.12Az			SUS316LN
		316C16						
		316S62	316LN		Z2CND17.13	2375		SUS316LN
X2CrNiMo18164	Type 19a	316S12	316L	X2CrNiMo17.13	Z3CND18.12.02	2353	X2CrNiMo1816-4	SUS316L
		316S16	316	X5CrNiMo17.13	Z6CND17.12	2343		SUS316
X2CrNiMo18164	Type 24	317S33	317L	X2CrNiMo18.16	Z3CND18.14.03	2367	X2CrNiMo1816-4	SUS317L
X2CrNiMoN17135				X2CrNiMoN17135				
						Z3CND225Az		
						Z1CNDU2520		
X6CrNiTi1810	Type 15	321S31	321	X6CrNiTi1811	Z6CNT18-10	2337	X6CrNiTi18-10	SUS321
X6CrNiNb1810	Type 16	347S31	347	X6CrNiNb1811	Z6CNNb18-10	2338	X6CrNiNb18-10	SUS347
		347C17			Z6CnNNb18-10M			SCS21
			631		Z9CNA17-07			
X6CrNiMoTi17122	Type 21	320S17	316Ti	X6CrNiMoTi1712	Z6CNDT17-12	2350	X6CrNiMoTi1712-2	
		320S33	316Ti	X6CrNiMo17.13				
X6CrNiMoNb17122	Type 23	318S17	316Cb	X6CrNiMoNb1712	Z6CNDNb17-12		X6CrNiMoNb1712-2	
		318C17		XG8CrNiMo	Z4CNDNb			SCS22
			318	X6CrNiMoNb	Z6CNDNb			



Materialgruppen Group of materials	Werkstoffe Materials		Zerspanungsgruppe Machinability-group	Werkstoff-Nr. German material code	DIN Bezeichnung DIN Symbol	Name	Zugfest min N(mm <sup>2</sup> ) Tensile strength min	Zugfest max N(mm <sup>2</sup> ) Tensile strength max	Bruchdehnung Elongation min. %	Bruchdehnung Elongation max. %	Glühhärt Annealing hardness
1.10 Hitzebeständige Stähle Heat-resisting steel	1.10	1.4700	8CrSi7-7				490	640	20	20	
	1.10	1.4712	X10CrSi6				540	690	18	18	
	1.10	1.4713	X10CrAl7				420	620	20	20	
	1.10	1.4718	X45CrSi9-3		Ventilstahl		900	1100	14	14	
	1.10	1.4720	X7CrTi12				400	600	25	25	
	1.10	1.4724	X10CrAl13				450	650	15	15	
	1.10	1.4742	X10CrAl18				500	700	12	12	
	1.10	1.4762	X10CrAl24				520	720	10	10	
	1.10	1.4821	X20CrNiSi25-4				600	850	16	16	
	1.10	1.4828	X15CrNiSi20-12				500	750	30	30	
	1.10	1.4833	X7CrNi23-14				500	750	26	26	
	1.10	1.4841	X15CrNiSi25-20				550	800	30	30	
	1.10	1.4845	X12CrNi25-21				500	750	35	35	
	1.10	1.4861	X10NiCr32-20				490	740	30	30	
	1.10	1.4864	X12NiCrSi36-16		Incoloy DS		550	800	30	30	
	1.10	1.4876	X10NiCrAlTi32-20		Incoloy 800		500	750	30	30	
	1.10	1.4878	X12CrNiTi18-9				500	750	40	40	
	1.10	1.4881	X70CrMnNiN21-6		Ventilstahl		980	1180	8	8	
	1.10	1.4885	X12CrNiMoNb20-15				590	730	40	40	
	1.10	1.4922	X20CrMoV12-1				780	850	16	16	
1.10	1.5310	8SiTi4				350	500	20	20		
1.10	1.5406	17MoV8-4				690	830	17	17		
1.10	1.7337	16CrMo4-4				540	690	20	20		
1.10	1.8070	21CrMoV5-11				690	830	16	16		
2 Gusseisen Cast iron											
2.11 Gusseisen mit Lamellengraphit (Grauguss) Grey cast iron	2.11	0.6010	GG-10		EN-GJL-100		100	150	0,3	0,8	150
	2.11	0.6015	GG-15		EN-GJL-150		150	200	0,3	0,8	160
	2.11	0.6020	GG-20		EN-GJL-200		200	300	0,3	0,8	180
	2.11	0.6025	GG-25		EN-GJL-250		250	350	0,3	0,8	190
	2.11	0.6030	GG-30		EN-GJL-300		300	400	0,3	0,8	200
	2.11	0.6035	GG-35		EN-GJL-350		350	450	0,3	0,8	210
2.12 Gusseisen mit Kugelgraphit (Sphäroguss) Spheroidal graphite cast iron (Nodular iron / Ductile iron)	2.12	0.7033	GGG-35-3				350	350	22	22	150
	2.12	0.7040	GGG-40		EN-GJS-400-15		370	390	12	15	185
	2.12	0.7043	GGG-40-3		EN-GJS-400-18		370	390	12	15	165
	2.12	0.7060	GGG-60		EN-GJS-600-3		550	600	1	2	250
	2.12	0.7070	GGG-70		EN-GJS-700-2		650	700	1	2	285
	2.12	0.7080	GGG-80		ADI		800	800	1	2	335
2.13 Temperguss Malleable cast iron											
2.13 Temperguss Malleable cast iron	2.13	0.8038	GTWS-38-12		EN-GJMW-360-12		320	400	8	15	200
	2.13	0.8040	GTW-40-05		EN-GJMW-400-5		360	420	4	8	220
	2.13	0.8045	GTW-45-07		EN-GJMW-450-7		400	450	4	10	220
	2.13	0.8055	GTW-55		EN-GJMW-550-4		490	570	3	5	250
	2.13	0.8135	GTS-35-10		EN-GJMB-350-10		350	350	10	10	150
	2.13	0.8145	GTS-45-06		EN-GJMB-450-6		450	450	6	6	200
	2.13	0.8155	GTS-55-04		EN-GJMB-550-4		550	550	4	4	230
	2.13	0.8165	GTS-65-02		EN-GJMB-650-2		650	650	2	2	260
	2.13	0.8170	GTS-70-02		EN-GJMB-700-2		700	700	2	2	290

EU	ISO	GB (BS)	USA (AISI/ASTM)	Italy (UNI)	France (AFNOR)	Sweden (SS)	Spain (UNE)	Japan (JIS)
X10CrAl7					Z8CA7		X10CrAl07	
		401S45	HW3	X45CrSi8	Z45CS9			SUH1
X5CrTi12					Z6CT12			
X10CrSiAl13	X10CrSiAl13	403S17	405	X10CrAl12	Z10C13		X10CrAl13	SUS405
X10CrSiAl18	X10CrSiAl18	403S15	430	X8Cr17	Z12CAS18		X10CrAl18	SUS430
X10CrSiAl24	X10CrSiAl25		446	X16Cr26	Z10CAS24	2322	X10CrAl24	SUH446
X15CrNiSi25-4					Z20CNS25.04		X15CrNiSi25.04	
X15CrNiSi20.12	X15CrNiSi20.12	309S24	309		Z15CN23.13		X10CrNiSi20.12	SUS309S
X6CrNi23-14	X6CrNi22-13		309S	X6CrNi23.14	Z15CN23.13			SUH309
X15CrNiSi25.21	X15CrNiSi25.21		314	X16CrNiSi25.20	Z15CNS25.20		X15CrNiSi25.20	
X6CrNi25.21	X6CrNi25.21	310S31	310S	X6CrNi25.20	Z12CN26.21	2361		SUH310
X12NiCrSi35.16	X12CrNiSi35.16	NA17	330		Z20NCS33.16		X12NiCrSi36.16	SUH330
X10NiCrAlTi32.21	X8CrNiAlTi32.21	NA15(H)			Z8NC33.21		X10NiCrAlTi32.20	NCF800
X10CrNiTi18-10	X7CrNiTi18.10	321S21	321	X6CrNiTi18.11	Z6CNT18.12	2337		SUS321

EN-JL 1010	Grade100	Grade100	A48-20B	G10	Ft10D	0110-00		
EN-JL 1020	Grade150	Grade150	A48-25B	G15	Ft15D	0115-00		Fi15
EN-JL 1030	Grade220	Grade220	A48-30B	G20	Ft20D	0120-00		Fi20
EN-JL 1040	Grade260	Grade260	A48-35B	G25	Ft25D	0125-00		Fi25
EN-JL 1050	Grade300	Grade300	A48-45B	G30	Ft30D	0130-00		Fi30
EN-JL 1060	Grade350	Grade350	A48-50B	G35	Ft35D	0135-00		Fi35

EN-JS 1030	400-15	Grade420/12	60-40-18	GS400-12	FGS400-15	0717-02		FCD400
EN-JS 1049		Grade370/17			FGS370-17	0717-15		FCD370
EN-JS 1050	500-15	Grade500/7	65-45-12	GS500-7	FGS500-7	0727-02		FCD500
EN-JS 1060	600-15	Grade600/3	80-55-06	GS600-3	FGS600-3	0732-03		FCD600
EN-JS 1070	700-15	Grade700/2	100-70-03	GS700-2	FGS700-2	0737-01		FCD700
EN-JS 1080	800-15		120-80-02	GS800-2	FGS800-2			FCD800

EN-JM 1010	W35-04	W35-04		GMB35	MB35-7		Type B	FCMW330
EN-JM 1020	W38-12	W38-12			MB380-12			
EN-JM 1030	W40-05	W40-05			MB400-5		Type A	FCMW370
EN-JM 1040	W45-07	W45-07	45006		MB450-7			FCMW440
EN-JM 1050			60004					
EN-JM 1130	B35-10	B35-12	32510	B35-10	MN35-10	08.15-00	Type A	
EN-JM 1140	P45-06	P45-06	40010	P45-06		08.54-00	Type E	
EN-JM 1160	P55-04	P55-04	50005	P55-04	MP50-5	08.56-00	Type C	
EN-JM 1180	P65-02	P65-02	70003	P65-02	MP60-3	08.62-03	Type B	
EN-JM 1190	P70-02	P70-02		P70-02	IP70-2	08.64-03	Type A	

Materialgruppen Group of materials	Werkstoffe Materials		Zerspanungsgruppe Machinability-group	Werkstoff-Nr. German material code	DIN Bezeichnung DIN Symbol	Name	Zugfest min N(mm <sup>2</sup> ) Tensile strength min	Zugfest max N(mm <sup>2</sup> ) Tensile strength max	Bruchdehnung Elongation min. %	Bruchdehnung Elongation max. %	Glühhärt Annealing hardness
<b>3</b>	<b>Kupferlegierungen</b> <i>Copper alloys</i>										
<b>3.20</b>	<b>Kupfer un-/niedriglegiert</b> <i>Copper, low alloyed</i>		<b>3.20</b>	2.0040	OF-Cu		250	370			
			<b>3.20</b>	2.0060	E-Cu57		250	370			
			<b>3.20</b>	2.0065	E-Cu58		250	370			
			<b>3.20</b>	2.0070	SE-Cu		250	370			
			<b>3.20</b>	2.0076	SW-Cu		250	370			
			<b>3.20</b>	2.0090	SF-Cu		250	370			
			<b>3.20</b>	2.1203	CuAg0,1		300	370			
			<b>3.20</b>	2.1245	CuBe1,7		400	500			
			<b>3.20</b>	2.1247	CuBe2		450	550			
			<b>3.20</b>	2.1285	CuCo2Be						
			<b>3.20</b>	2.1293	CuCrZr						
			<b>3.20</b>	2.1310	CuFe2P						
<b>3.21</b>	<b>Kupfer-Zinklegierung, Messing kurzspanend</b> <i>short chipping brass</i>		<b>3.21</b>	2.0290	G-CuZn33Pb2	G-Ms65	180	180	12	12	50
			<b>3.21</b>	2.0331	CuZn35Pb2	Ms63Pb					
			<b>3.21</b>	2.0332	CuZn37Pb0,5	Ms63Pb					
			<b>3.21</b>	2.0372	CuZn39Pb0,5	Ms60Pb					
			<b>3.21</b>	2.0375	CuZn36Pb3						
			<b>3.21</b>	2.0380	CuZn39Pb2	Ms58	380	500			
			<b>3.21</b>	2.0401	CuZn39Pb3	Ms58					
			<b>3.21</b>	2.0402	CuZn40Pb2	Ms58					
			<b>3.21</b>	2.0580	CuZn40Mn1Pb1	SoMs58Pb	380	500			
<b>3.22</b>	<b>Kupfer-Zinklegierung, Messing langspanend</b> <i>long chipping brass</i>		<b>3.22</b>	2.0220	CuZn5	Ms95	150	220			
			<b>3.22</b>	2.0240	CuZn15	Ms85					
			<b>3.22</b>	2.0250	CuZn20	Ms80					
			<b>3.22</b>	2.0261	CuZn28	Ms72	300	440			
			<b>3.22</b>	2.0265	CuZn30	Ms70					
			<b>3.22</b>	2.0280	CuZn33	Ms67					
			<b>3.22</b>	2.0321	CuZn37	Ms63	310	550			
			<b>3.22</b>	2.0330	CuZn10	Ms90	380	500			
			<b>3.22</b>	2.0335	CuZn36		310	550			
			<b>3.22</b>	2.0360	CuZn40	Ms60	340	490			
			<b>3.22</b>	2.0421	G-CuZn15		160	160	20	20	45
			<b>3.22</b>	2.0460	CuZn20Al2As	SoMs76					
			<b>3.22</b>	2.0470	CuZn28Sn1As	SpMs71					
			<b>3.22</b>	2.0490	CuZn31Si1	SoMs68					
			<b>3.22</b>	2.0530	CuZn39Sn1	SoMs60					
			<b>3.22</b>	2.0591	G-CuZn38Al	G-Ms60	380	380	30	30	75
			<b>3.22</b>	2.0595	G-CuZn37Al1	G-SoMsF45	450	450	25	25	105
			<b>3.22</b>	2.0598	G-CuZn25Al5Mn4Fe3	SoMs75	750	750	3	8	190
			<b>3.22</b>		CuZn21Si3P	Ecobrass / Cuphin	500	670	10	15	170
<b>3.23</b>	<b>Kupfer-Aluminiumlegierung, Aluminium-Bronze, langspanend</b> <i>Copper-aluminium alloys</i>		<b>3.23</b>	2.0916	CuAl5	AlBz5	340	440	18	50	100
			<b>3.23</b>	2.0932	CuAl8Fe3	AlBz8	470	590	10	25	120
			<b>3.23</b>	2.0940	G-CuAl10Fe2	G-FeAlBzF50	500	600	15	20	130
			<b>3.23</b>	2.0966	CuAl10Ni5Fe4	AlBz10Ni	500	800	12	14	140
			<b>3.23</b>	2.0975	G-CuAl10Fe5Ni5	G-NiAlBzF60	600	650	7	13	150

EU	ISO	GB (BS)	USA (AISI/ASTM)	Italy (UNI)	France (AFNOR)	Sweden (SS)	Spain (UNE)	Japan (JIS)
CW008A	Cu-OF	C103	OF	Cu-OF	Cu/c2	145011		
CW005A	Cu-FRHC	C102	FRHC		Cu/a2	145013		
CW004A	Cu-ETP	C101	ETP	Cu-ETP	Cu/a1	145010		
CW023A	Cu-DLP		DLP	Cu-DLP				
CW024A	CU-DHP	C106	C12200	Cu-DHP	Cu/b	145015		
Cr013A		CuAG4	C11600/STP					
CW100C		CB101	C17000					
CW101C			C17200					
CW104C		C112	C17500					
CW106C		CC102	C18200					
CW107C			C19400					
CB750S								
CW601N								
CW604N			C33500					
CW610N								
CW603N		CZ124	C36000		UZ36Pb3		C6425	C3603
CW612N				P-OT59Pb	A51101	145168		
CW614N			C38500		A51105			
CW617N		CZ122						
CW720R								
CW500L		CZ125	C21000		UZ5		C6105	
CW502L		CZ102	C23000	P-CuZn15	UZ15		C6115	C2300
CW503L		CZ103	C24000	P-CuZn20	UZ20		C6120	C2400
CW504L							C6128	
CW505L		CZ106	C26000	P-OT70	UZ30		C6130	C2600
CW506L		CZ107	C26800		UZ33		C6133	C2680
CW508L		CZ108	C27200		UZ36		C6137	
CW501L		CZ101	C22000					
CW507L			C27000					
CW509L		CZ109	C28000	P-OT60	UZ40		C6140	
CB760S		SCB6						
CW702R		CZ110	C68700	P-OTS77Al	UZ22A2			
CW706R		CZ111	C44300					
CW708R			C69800					
CW719R								
CB767S		DCB1						
CB766S								
CB762S		HTB3	C86300					
CW724R			C69300					
CW300G			C60800					
CW303G		CA106	C61400					
CB331G		AB1	C95200					
CW307G		CA104	C63200					
CC333G								

Materialgruppen Group of materials	Werkstoffe Materials	Zerspanungsgruppe Machinability-group	Werkstoff-Nr. German material code	DIN Bezeichnung DIN Symbol	Name	Zugfest min N(mm <sup>2</sup> ) Tensile strength min	Zugfest max N(mm <sup>2</sup> ) Tensile strength max	Bruchdehnung Elongation min. %	Bruchdehnung Elongation max. %	Glühhärtigkeit Annealing hardness
3.24	Kupfer-Zinnlegierung, Zinnbronze, Rotguss, kurzspanend <i>Copper-zinc alloys</i>	3.24	2.1020	CuSn6	SnBz6	350	500			
		3.24	2.1030	CuSn8	SnBz8	450	600			
		3.24	2.1050	G-CuSn10	G-SnBz10	250	280	10	18	80
		3.24	2.1052	G-CuSn12	G-SnBz12	260	300	5	7	90
		3.24	2.1060	G-CuSn12Ni2		280	300	8	12	95
		3.24	2.1090	G-CuSn7Zn4Pb7	Rg7	230	260	12	15	70
		3.24	2.1096	G-CuSn5Zn5Pb5	Rg5	200	250	6	13	65
4	Leichtmetall-Legierungen <i>Light metal alloys</i>									
4.14	Aluminium und Aluminiumknetlegierung <i>Unalloyed aluminium and wrought alu-alloys</i>	4.14	3.0526	AlMn1Mg1		100	190			
		4.14	3.0205	Al99,0						
		4.14	3.0255	Al99,5						
		4.14	3.0257	EAl99,5						
		4.14	3.0275	Al99,7						
		4.14	3.0285	Al99,8						
		4.14	3.0305	Al99,9						
		4.14	3.0385	Al99,98R						
		4.14	3.0400	Al99,99R						
		4.14	3.0505	AlMn0,5Mg0,5						
		4.14	3.0506	AlMn0,6						
		4.14	3.0515	AlMn			100	190		
		4.14	3.0516	A-AlMn						
		4.14	3.0517	AlMnCu						
		4.14	3.0525	AlMn1Mg0,5						
		4.14	3.0615	AlMgSiPB			200	275		
		4.14	3.0915	AlFeSi						
		4.14	3.1255	AlCuSiMn						
		4.14	3.1305	AlCu2,5Mg0,5						
		4.14	3.1325	AlCu4MgSi						
		4.14	3.1355	AlCu4Mg2						
		4.14	3.1645	AlCuMgPb				370		
		4.14	3.1655	AlCuBiPb						
		4.14	3.2315	AlMgSi1			102	215		
		4.14	3.3206	AlMgSi0,5						
		4.14	3.3207	E-AlMgSi0,5						
		4.14	3.3208	Al99,9MgSi			95	130		
		4.14	3.3210	AlMgSi0,7						
		4.14	3.3214	AlMgSiCu						
		4.14	3.3307	Al99,85Mg0,5			95	130		
		4.14	3.3308	Al99,9Mg0,5			95	130		
		4.14	3.3309	AlMg0,5			170	240		
		4.14	3.3315	AlMg1			170	240		
		4.14	3.3316	AlMg1,5			170	240		
		4.14	3.3317	Al99,85Mg1			95	130		
		4.14	3.3319	AlRMg1						
		4.14	3.3326	AlMg1,8						
		4.14	3.3345	AlMg4,5						
		4.14	3.3523	AlMg2,5						
		4.14	3.3525	AlMg2Mn0,3			180	200		
		4.14	3.3527	AlMg2Mn0,8						
4.14	3.3535	AlMg3			170	240				
4.14	3.3537	AlMg2,7Mn								
4.14	3.3545	AlMg4Mn								
4.14	3.3547	AlMg4,5Mn								

EU	ISO	GB (BS)	USA (AISI/ASTM)	Italy (UNI)	France (AFNOR)	Sweden (SS)	Spain (UNE)	Japan (JIS)
CW452K		PB101	C51100					
CW453K		PB104	C52100	B8	UE9P			
CB480K		CT1	C90250					
CB483K		PB2	C90800					
CB484K		CT2	C91799					
CB493K			C93200					
CB491K		LG2	C83600					

3004				9003/2	A-M1G			A3004
1200		1C	A91200	AI99,0	A4	144010		A1200
1050A		1B		9001/2	A5	144007		A1x1
1350A								
1070A				9001/3	A7			
1080A		1A		9001/4	A8			
			A91085		A9			
1098								
3105		N31	A93105	9003/5	A-M05G05			A3105
3207								
3103	AlMn1	N3		9003/3				
3003	AlMn1Cu	3103	A39003	9003/1	A-M1		L-3810	A3003
3005			93005	9003/4	A-MG0,5			A3005
6012								
8011A			98011		A-FeS			
2014	AlCu4SiMg	2014A	A92014	9002/3	A-4USG		L-3130	A2014
2117	AlCu2,5Mg			9002/1	A-U2G			A2117
2017A				3579	A-U4G		L-3120	A2017
2024	AlCu4Mg1	2L97	A92924	9002/4	A-U4G1		L-3140	A2024
2007	AlCu4PbMg			9002/8				
2011	AlCu6BiPb	FC1		9002/5	A-U5PbBi			
6082		H30			A-SGM0,7			
6060	AlMgSi			9006/1	A-GS	144103		
6101B		91E	A96101		A-GS/L	144102	L34-31	A6101
6401								
6005A				9006/6	A-GS0,5			
6061	AlMg1SiCu	H20		9006/2	A-GSUC			
5110								
5505								
5310								
5005A		N41	A95005	5764	A-G0.6	144106	L-3350	A2x8
5050B		3L44	A95050	9005/7	A-G1.5		L-3380	
5305								
5605								
5051A								A5052
5082					A-G4,5			A5082
5052				9005/2	A-G2.5C			
5251	AlMg2	N4			A-G2M			
5049								
5754					A-G3M			
5454	AlMg3Mn	N51		9005/3	A-G2,5MC			A5454
5086	AlMg4			9005/4	A-G4MC			A5086
5083		N8	A95083	9005/5	A-G4,5MC	144140	L-3321	A5083



Materialgruppen Group of materials	Werkstoffe Materials		Zerspanungsgruppe Machinability-group	Werkstoff-Nr. German material code	DIN Bezeichnung DIN Symbol	Name	Zugfest min N(mm <sup>2</sup> ) Tensile strength min	Zugfest max N(mm <sup>2</sup> ) Tensile strength max	Bruchdehnung Elongation min. %	Bruchdehnung Elongation max. %	Glühhärtigkeit Annealing hardness
4.14 Aluminium und Aluminiumknetlegierung <i>Unalloyed aluminium and wrought alu-alloys</i>	4.14	3.3549	AlMg5Mn								
	4.14	3.3555	AlMg5								
	4.14	3.4335	ALZn4,5Mg1								
	4.14	3.4345	AlZnMgCu0,5								
	4.14	3.4365	AlZnMgCu1,5					530			
	4.14	3.4415	ALZn1								
4.15 Aluminiumgusslegierung < 10% Si <i>Aluminium casting alloys &lt; 10% Si</i>	4.15	3.1371	G-AlCu4TiMg				300	320	5	8	90
	4.15	3.1841	G-AlCu4Ti				280	320	3	8	90
	4.15	3.2134	G-AlSi5Cu1Mg								
	4.15	3.2151	G-AlSi6Cu4				150	170	1	1	75
	4.15	3.2161	G-AlSi8Cu3				160	250			
	4.15	3.2162	GD-AlSi8Cu3								
	4.15	3.2163	GD-AlSi9Cu3				150	240	1	1	75
	4.15	3.2341	G-AlSi5Mg				160	250			
	4.15	3.2371	G-AlSi7Mg				180	210	2	8	80
	4.15	3.2373	G-AlSi9Mg				230	290	2	6	80
	4.15	3.2382	G-AlSi10Mg				240	240	1	1	70
	4.15	3.2385	GD-AlSi10Mg								
	4.15	3.3241	G-AlMg3Si				140	280	2	10	65
	4.15	3.3261	G-AlMg5Si				160	180	3	3	65
	4.15	3.3292	GD-AlMg9				200	200	1	1	70
	4.15	3.3561	G-AlMg5				160	180	3	4	60
4.15	3.3581	G-AlSi12				150	230	5	12	60	
4.16 Aluminiumgusslegierung > 10% Si <i>Aluminium casting alloys &gt; 10% Si</i>	4.16	3.2211	G-AlSi11				150	170	6	7	45
	4.16	3.2381	G-AlSi10Mg				150	260	1	2,5	75
	4.16	3.2383	G-AlSi10Mg(Cu)				160	240	1	1	75
	4.16	3.2581	G-AlSi12				150	170	5	6	55
	4.16	3.2582	GD-AlSi12(Fe)				240	240	1	1	60
	4.16	3.2583	G-AlSi12(Cu)				150	240	1	4	55
	4.16	3.2982	GD-AlSi12(Cu)				240	240	1	1	70
4.17 Magnesium-Legierungen <i>Magnesium alloys</i>	4.17	3.5470	G-MgAl4Si1		AS41		200	250	3	6	
	4.17	3.5662	G-MgAl6		A6		190	230	4	8	
	4.17	3.5712	G-MgAl8Zn1		AZ81		160	230	2	6	
	4.17	3.5912	G-MgAl9Zn1		AZ91		160	220	2	5	
4.18 Zink-Legierungen <i>Zinc alloys</i>	4.18	-	ZnAl4		ZL3 (Zamak Z410)		250	300	3	6	
	4.18	-	ZnAl4Cu1		ZL5 (Zamak Z410)		280	350	2	5	
	4.18	-	ZnAl4Cu3		ZL2 (Zamak Z430)		360	400	2	5	
	4.18	-	ZnAl6Cu1		ZL6 (Zamak Z610)		350	400	3	6	
	4.18	-	ZnAl11Cu1		ZL12		390	415	2	3	
	4.18	-	ZnAl27Cu2		ZL27		405	440	1	2	
<b>5 Sonderlegierungen Special alloys</b>											
5.25 Nickellegierungen <i>Nickel alloys</i>	5.25	2.0872	CuNi10Fe1Mn		Cupronickel 90/10						
	5.25	2.0882	CuNi30Mn1Fe		Cupronickel 70/30						
	5.25	2.4061	Ni99,6		Nickel205		424	424	45	45	
	5.25	2.4066	Ni99,2		Nickel200		469	469	47	47	
	5.25	2.4068	LC-Ni99		Nickel201		403	403	50	50	
	5.25	2.4360	NiCu30Fe		Monel400		565	565	45	45	
	5.25	2.4375	NiCu30Al		MonelK-500		1179	1179	19	19	
	5.25	2.4602	NiCr21Mo14W		Inconel 622		793	793	54	54	

EU	ISO	GB (BS)	USA (AISI/ASTM)	Italy (UNI)	France (AFNOR)	Sweden (SS)	Spain (UNE)	Japan (JIS)
5182					A-G4,5M			A5182
5019		N6		AlMg5	AlMg5		L-3320	
7020		H17		9007/1	A-Z5G	144425	L-3741	
7022								
7075		2L88	B209	9007/2	A-Z5GU		L-3710	A7075
7072								

21000	Al-Cu4MgTi		204.0		A-U5GT			AC1B
21100	Al-Cu4Ti							
45000	Al-Si6Cu4	LM21	319.0	7369/4	A-S5UZ			AC2B
	AlSi8Cu3Fe							
46200	Al-Si8Cu3	LM24	380.0	7369/3	A-S9U3			
	Al-Si5Mg							
42100	Al-Si7Mg	2L99	A357.0	8024	A-S7G03			AC4CH
43300			359.0	3051	A-S9G			AC4A
43400					A-S10G			
G-AlMg3Si	Al-Mg3Si2		515.0					
51400	Al-Mg5Si1							
51200								
51300	Al-Mg6			3058	A-G3T			
G-AlSi12	Al-Si12	LM6	B413.0	3051	A-S13			AC3

44000								
43000	Al-Si10Mg				A-S10G			
43200					A-S10GU			
44200	Al-Si12	LM6	B413.0	3051	A-S13			AC3
44300	Al-Si12Fe	LM20		4514	A-S12			
47000	Al-Si12CuFe		A413.0	3048	A-S12U			
47100	AlSi12CuFe	LM20	384.0	5076	A-Si12U			ADC12

			AM60A					

ZnAl4	ZnAl4	Alloy A	AG40A	ZA4	Z-A4G	ZnAl4	F-ZnAl4	Class 2
ZnAl4Cu1	ZnAl4Cu1	Alloy B	AC41A	ZA4C1	Z-A4U1G	ZnAl4Cu1	F-ZnAlCu4-1	Class 1
ZnAl4Cu3			AC43A		Z-A4U3G			
ZnAl6Cu1								
ZnAl11Cu1								
ZnAl27Cu2								

			8.9		CuNi10Fe			
		CN107	C71500		CuNi30Mn1Fe	145682		C7150
			D=8.9		Ni01			VCNIT1B
		NA11	F1 Grade 2		Ni02			NNCP
		NA13	N04400		Nu30			
			8.5					
			N06022					

Materialgruppen Group of materials	Werkstoffe Materials	Zerspanungsgruppe Machinability-group	Werkstoff-Nr. German material code	DIN Bezeichnung DIN Symbol	Name	Zugfest min N(mm <sup>2</sup> ) Tensile strength min	Zugfest max N(mm <sup>2</sup> ) Tensile strength max	Bruchdehnung Elongation min. %	Bruchdehnung Elongation max. %	Glühhärt Annealing hardness
5.25 Nickellegierungen <i>Nickel alloys</i>		5.25	2.4603	NiCr30FeMo	Hastelloy G30	610	850			
		5.25	2.4605	NiCr23Mo16Al	Alloy59					
		5.25	2.4606	NiCr21Mo16W	Inconel 686	758	758	60	60	
		5.25	2.4610	NiMo16Cr16Ti	Hastelloy C4					
		5.25	2.4617	NiMo28	Hastelloy B2					
		5.25	2.4618	NiCr22Mo6Cu	Hastelloy G					
		5.25	2.4619	NiCr22Mo7Cu	Inco alloy G-3	690	690	50	50	
		5.25	2.4630	NiCr20Ti	Nimonic 75	758	758	40	40	
		5.25	2.4631	NiCr20TiAl	Nimonic 80A	1241	1241	30	30	
		5.25	2.4632	NiCr20Co18Ti	Nimonic 90	1172	1172	30	30	
		5.25	2.4634	NiCo20Cr15MoAlTi	Nimonic 105	1138	1138	22	22	
		5.25	2.4636	NiCo15Cr15MoAlTi	Nimonic 115	1240	1240	27	27	
		5.25	2.4642	NiCr29Fe	Inconel 690	696	696	45	45	
		5.25	2.4650	NiCo20Cr20MoTi	Nimonic 263	965	965	39	39	
		5.25	2.4654	NiCr19Co14Mo4Ti	Waspaloy	1310	1310	29	29	
		5.25	2.4660	NiCr20CuMo	Inco alloy 020	683	683	35	35	
		5.25	2.4662	NiCr13Mo6Ti3	Nimonic 901	1220	1220	15	15	
		5.25	2.4663	NiCr23Co12Mo	Inconel 617	724	724	62	62	
		5.25	2.4665	NiCr22Fe18Mo	Inco alloy H X	772	772	47	47	
		5.25	2.4668	NiCr19NbMo	Inconel 718	1345	1345	17	17	
		5.25	2.4669	NiCr15Fe7RiAl	Inconel X-750	1241	1241	25	25	
		5.25	2.4692		Incoloy 909	1276	1276	15	15	
		5.25	2.4693	NiCr25Mo7Ti	Incoloy 907	1207	1207	14	14	
		5.25	2.4816	NiCr15Fe	Inconel 600	683	383	43	43	
		5.25	2.4819	NiMo16Cr15W	Inco alloy C-276	793	793	60	60	
		5.25	2.4851	NiCr23Fe	Inconel 601	634	634	56	56	
		5.25	2.4856	NiCr22Mo9Nb	Inconel 625	896	896	50	50	
		5.25	2.4858	NiCr21Mo	Incoloy 825	690	690	45	45	
		5.25	2.4864		Incoloy 330	586	586	42	42	
		5.25	2.4867	NiCr60 15	Brightway B	620	620	45	45	
	5.25	2.4869	NiCr80 20	Brightway C	760	760	30	30		
	5.25	2.4980		Inco alloy A-286	1131	1131	25	25		
5.26 Titan und Titanlegierungen <i>Titanium and Titanium alloys</i>		5.26	3.7025	Ti 99,5	Reintitan	290	410	30	30	120
		5.26	3.7035	Ti 99,7	Reintitan	390	540	22	22	150
		5.26	3.7055	Ti 99,4	Reintitan	460	590	18	18	170
		5.26	3.7065	Ti 99,2	Reintitan	540	740	16	16	200
		5.26	3.7165	Ti6Al4V		890	1000	10	10	

EU	ISO	GB (BS)	USA (AISI/ASTM)	Italy (UNI)	France (AFNOR)	Sweden (SS)	Spain (UNE)	Japan (JIS)
		Hr6	8.2					
			8.5					
			8.6					
			9.2		ADNiC265D			
			N06007					
			8.3					
		HR5	8.4		NC20T			
		NA20	B637		NC20TA			NCF80A
		ANC10	8.2		NCK20TA			
			8		NK20CDA			
		HR4						
			N06690					
		NA38						
		NA37	N07001					
			8		Z2NCUD31-20Az			
			N06617		NC22KDA			
		NA60	N06002		NC22FeD			
		VMA13	N07718		NC19FeNb			
		HR505	8.3		NC15FeT			
		NA14	N06600		NC15Fe			NCF600
			A567 Grade 4		NiMo16Cr15			
			N06601		NC23Fe			
			N06625		NC22DNb			NCF601
		NA41	N08825		NCF825			
			B344					
		2TA1	Grade 1					
			Grade 2					T35
			Grade 3					
			Grade 4					
		TA28	Grade 5		TA 6V			

# Katalog-Nr. Verzeichnis / List of catalogue-no's

Kat. Nr. Cat. No.	Seite Page	Kat. Nr. Cat. No.	Seite Page	Kat. Nr. Cat. No.	Seite Page	Kat. Nr. Cat. No.	Seite Page	Kat. Nr. Cat. No.	Seite Page	Kat. Nr. Cat. No.	Seite Page
100100	G124	110241	G40	110329	G25	110455	G34	111354	G58	112256	G72
100101	G124	110242	G40	110331	G25	110456	G34	111356	G59	112257	G72
100102	G125	110243	G40	110332	G25	110457	G35	111357	G59	112260	G71
100103	G125	110244	G41	110333	G25	110458	G35	111360	G60	112263	G71
110000	G1	110245	G41	110334	G25	110500	G38	111363	G60	112266	G71
110001	G0	110246	G41	110335	G24	110530	G36	111365	G60	112267	G71
110002	G0	110247	G41	110336	G24	110531	G36	111366	G60	112268	G71
110003	G0	110248	G41	110338	G25	110532	G36	111367	G61	112269	G71
110010	G3	110249	G41	110339	G42	110550	G37	111368	G61	112270	G72
110011	G3	110252	G17	110341	G42	110551	G37	111369	G60	112271	G72
110012	G3	110253	G16	110342	G42	110552	G37	111370	G59	112273	G73
110013	G3	110254	G16	110343	G42	110600	G6	111371	G59	112274	G73
110020	G1	110256	G19	110344	G43	110601	G6	111373	G61	112276	G73
110021	G0	110257	G19	110345	G43	110602	G6	111374	G61	112277	G73
110040	G5	110260	G18	110346	G43	110605	G6	111376	G61	112278	G73
110041	G4	110261	G18	110347	G43	110606	G6	111377	G61	112279	G73
110042	G4	110263	G19	110349	G43	110607	G7	111380	G58	112281	G71
110043	G4	110265	G19	110352	G26	110608	G7	111381	G59	112292	G73
110050	G5	110266	G18	110353	G25	110609	G7	111382	G59	112293	G73
110051	G4	110267	G19	110354	G25	110611	G7	111383	G58	112295	G69
110100	G10	110268	G19	110356	G28	110612	G7	111384	G59	112296	G70
110118	G10	110269	G18	110357	G28	110613	G8	111385	G59	112300	G74
110126	G10	110270	G19	110360	G27	110614	G8	111392	G61	112305	G74
110180	G10	110271	G19	110361	G27	110615	G8	111393	G61	112310	G74
110184	G10	110273	G20	110363	G27	110616	G7	111395	G57	112318	G74
110200	G11	110274	G20	110365	G27	110617	G7	111396	G57	112326	G75
110201	G11	110276	G21	110366	G27	110618	G7	111452	G65	112335	G75
110202	G12	110277	G21	110367	G27	110619	G7	111453	G65	112345	G79
110204	G11	110278	G21	110368	G27	110685	G9	111454	G65	112352	G75
110205	G11	110279	G21	110369	G27	110686	G9	111455	G65	112353	G75
110206	G12	110280	G17	110370	G28	111060	G46	111456	G65	112356	G77
110207	G12	110281	G17	110371	G28	111061	G46	111600	G51	112357	G77
110208	G13	110282	G17	110373	G29	111062	G46	111601	G51	112360	G75
110209	G13	110283	G17	110374	G29	111070	G46	111602	G51	112363	G76
110210	G11	110284	G17	110376	G29	111071	G46	111605	G51	112366	G75
110212	G13	110285	G17	110377	G29	111072	G46	111606	G51	112367	G76
110214	G12	110286	G30	110378	G29	111080	G49	111607	G53	112368	G76
110215	G13	110287	G30	110379	G29	111081	G49	111608	G53	112369	G75
110216	G13	110288	G31	110380	G26	111082	G49	111609	G53	112370	G76
110218	G13	110289	G31	110381	G26	111090	G50	111611	G52	112371	G76
110219	G13	110291	G21	110382	G26	111092	G50	111612	G52	112373	G77
110220	G13	110292	G20	110383	G26	111200	G54	111613	G53	112374	G77
110221	G14	110293	G20	110386	G30	111205	G54	111614	G53	112376	G77
110222	G15	110295	G12	110387	G30	111210	G54	111615	G53	112377	G77
110223	G14	110296	G15	110388	G31	111218	G54	111616	G53	112381	G75
110224	G13	110297	G19	110389	G31	111226	G54	111617	G53	112392	G77
110225	G14	110300	G22	110391	G29	111235	G55	111618	G53	112393	G77
110226	G14	110301	G22	110392	G29	111300	G56	111619	G52	112395	G74
110227	G16	110302	G23	110393	G29	111304	G56	112000	G68	112396	G75
110228	G15	110304	G22	110395	G23	111305	G56	112001	G68	112600	G78
110229	G15	110305	G22	110396	G24	111307	G56	112002	G68	112607	G78
110230	G15	110307	G23	110397	G28	111310	G56	112003	G68	112613	G78
110231	G15	110309	G23	110402	G32	111318	G57	112200	G69	112616	G78
110232	G15	110310	G22	110403	G32	111324	G57	112205	G69	112619	G78
110233	G15	110312	G23	110404	G32	111325	G57	112210	G69	113060	G81
110234	G16	110318	G23	110405	G32	111326	G57	112216	G69	113061	G81
110235	G14	110320	G23	110406	G32	111329	G57	112218	G70	113062	G81
110236	G15	110323	G24	110407	G33	111332	G57	112226	G70	113200	G83
110237	G17	110324	G23	110408	G33	111335	G57	112235	G70	113205	G83
110238	G16	110325	G23	110452	G34	111345	G66	112245	G79	113210	G83
110239	G40	110326	G24	110453	G34	111352	G58	112252	G71	113216	G83
110240	G40	110327	G25	110454	G34	111353	G58	112253	G70	113218	G84

# Katalog-Nr. Verzeichnis / List of catalogue-no's

Kat. Nr. Cat. No.	Seite Page	Kat. Nr. Cat. No.	Seite Page	Kat. Nr. Cat. No.	Seite Page	Kat. Nr. Cat. No.	Seite Page	Kat. Nr. Cat. No.	Seite Page	Kat. Nr. Cat. No.	Seite Page
113226	G84	114105	G99	117100	G109	135252	G80	214201	S21	L14100	L12
113235	G84	114118	G99	117101	G109	135305	G80	214220	S21	L14200	L12
113245	G92	114180	G99	117103	G109	135326	G80	214222	S21	L14400	L12
113252	G85	114184	G99	117300	G110	135352	G80	215000	S26	L14500	L12
113253	G84	114187	G99	117303	G110	136205	G93	215001	S26	L15000	L9
113256	G86	114300	G100	117363	G110	136226	G93	215002	S26	L15100	L9
113257	G86	114305	G100	117364	G111	136252	G93	215005	S26	L15200	L9
113260	G85	114310	G100	117376	G111	136305	G93	217000	S23	L15400	L9
113263	G85	114318	G100	117381	G110	136326	G93	217001	S23	L15500	L9
113266	G85	114326	G100	118100	G112	136352	G93	217005	S23	L17000	L14
113267	G85	114327	G101	118300	G113	210000	S2	218000	S24	L17300	L14
113268	G85	114335	G101	118381	G113	210001	S2	218001	S24	L18000	L15
113269	G85	114345	G104	119060	G114	210002	S2	218005	S24	L18300	L15
113270	G86	114353	G101	119061	G114	210005	S3	219000	S25	L19000	L18
113271	G86	114356	G103	119062	G114	210006	S3	219001	S25	L19400	L18
113273	G87	114357	G103	119300	G115	210007	S3	219020	S25	L19500	L18
113274	G87	114360	G101	119305	G115	210008	S3	221000	S27	L21000	L16
113276	G87	114363	G102	119600	G115	210010	S2	221002	S27	L21100	L16
113277	G87	114366	G101	119601	G115	210011	S2	221020	S27	L21200	L16
113278	G87	114367	G102	121000	G120	210020	S3	221022	S27	L21400	L16
113279	G87	114368	G102	121001	G120	210101	S6	222000	S28	L21500	L16
113281	G85	114369	G101	121002	G120	210105	S6	222001	S28	L22000	L17
113292	G87	114370	G103	121003	G120	210106	S6	222020	S28	L22100	L17
113293	G87	114371	G103	121010	G121	210110	S6	222023	S28	L22200	L17
113295	G83	114373	G103	121011	G121	210120	S6	223000	S22	L22400	L17
113296	G84	114374	G103	121012	G121	210201	S9	223005	S22	L22500	L17
113300	G88	114380	G101	121013	G121	210205	S9	223020	S22	L23000	L13
113305	G88	114381	G101	121510	G122	210211	S9	L10000	L2	L23300	L13
113310	G88	114383	G101	121511	G122	210214	S9	L10001	L2	L24000	L13
113318	G88	114392	G103	121600	G123	210220	S9	L10005	L3	L24300	L13
113326	G89	114393	G103	121610	G123	210301	S10	L10006	L3	L33000	L8
113335	G89	114600	G96	122600	G119	210320	S10	L10100	L2	L50000	L19
113345	G92	114601	G96	122610	G119	210401	S8	L10101	L2	L50300	L20
113352	G89	114602	G96	122620	G119	210405	S8	L10200	L2	L50400	L20
113353	G89	114605	G96	123300	G106	210411	S8	L10201	L2	L50500	L20
113356	G91	114606	G96	123305	G106	210414	S8	L10400	L3	L77000	L21
113357	G91	114607	G97	123310	G106	210420	S8	L10401	L3	L77001	L21
113360	G89	114608	G97	123326	G106	211000	S11	L10500	L3	L77002	L21
113363	G90	114609	G97	123335	G106	211001	S11	L10501	L3	L77003	L21
113366	G89	114611	G97	123356	G107	211002	S11	L11000	L4	L77004	L21
113367	G90	114612	G97	123357	G107	211005	S12	L11001	L4	L77005	L21
113368	G90	114613	G98	123360	G107	211008	S12	L11005	L5	L77006	L21
113369	G89	114614	G98	123363	G107	211010	S11	L11100	L4	L77100	L21
113370	G90	114615	G98	123366	G107	211011	S11	L11101	L4	L77103	L21
113371	G90	114616	G97	123367	G107	211020	S12	L11200	L4	L77900	L21
113373	G91	114617	G97	123370	G107	211401	S17	L11201	L4	L88000	L23
113374	G91	114618	G97	123371	G107	211420	S17	L11400	L5	L88001	L23
113376	G91	114619	G97	123600	G105	212000	S18	L11401	L5	L88002	L23
113377	G91	115000	G116	123601	G105	212001	S18	L11500	L5	L88003	L23
113381	G89	115001	G116	124300	G108	212002	S18	L11501	L5	L88004	L23
113392	G91	115002	G116	124363	G108	212005	S18	L12000	L10	L88005	L23
113393	G91	115003	G116	127326	G94	212010	S18	L12100	L10	L88006	L23
113395	G88	115200	G117	127360	G94	213000	S19	L12200	L10	L88100	L23
113396	G89	115205	G117	127363	G94	213001	S19	L12400	L10	L88103	L23
113600	G82	115218	G117	133205	G44	213002	S19	L12500	L10		
113607	G82	115226	G117	133226	G44	213005	S19	L13000	L11		
113613	G82	115281	G117	133252	G44	213010	S19	L13100	L11		
113616	G82	115300	G118	133305	G45	214000	S20	L13200	L11		
113619	G82	115305	G118	133326	G45	214001	S20	L13400	L11		
114060	G95	115318	G118	133352	G45	214005	S20	L13500	L11		
114061	G95	115326	G118	135205	G80	214020	S20	L14000	L12		
114062	G95	115381	G118	135226	G80	214022	S20	L14005	L12		



# Allgemeine Geschäftsbedingungen

## I. Allgemeines

Allen Lieferungen und Leistungen liegen diese Bedingungen sowie etwaige gesonderte vertragliche Vereinbarungen zugrunde. Abweichende Einkaufsbedingungen des Bestellers werden auch durch Auftragsannahme nicht Vertragsinhalt.

Ein Vertrag kommt - mangels besonderer Vereinbarung - mit der schriftlichen Auftragsbestätigung des Lieferanten zustande.

## II. Angebot

- Die zu dem Angebot gehörigen Unterlagen wie Abbildungen, Zeichnungen, Gewichts- und Maßangaben, sind nur annähernd maßgebend, soweit sie nicht ausdrücklich als verbindlich bezeichnet sind. An Kostenanschlägen, Zeichnungen und anderen Unterlagen behält sich der Lieferer Eigentums- und Urheberrechte vor; sie dürfen Dritten nicht zugänglich gemacht werden. Der Lieferer ist verpflichtet, vom Abnehmer als vertraulich bezeichnete Pläne nur mit dessen Zustimmung Dritten zugänglich zu machen. Die Preise der Angebote gelten für Bestellungen innerhalb von 30 Tagen ab Angebotsdatum.
- Der Besteller übernimmt für die von ihm beizubringenden Unterlagen, wie Zeichnungen, Lehren, Muster oder dergl. die alleinige Verantwortung. Der Besteller hat dafür einzustehen, dass von ihm vorgelegte Ausführungszeichnungen in Schutzrechte Dritter nicht eingreifen. Der Lieferer ist dem Besteller gegenüber nicht zur Prüfung verpflichtet, ob durch Abgabe von Angeboten aufgrund ihm eingesandter Ausführungszeichnungen im Falle der Ausführung irgendwelche Schutzrechte Dritter verletzt werden. Ergibt sich trotzdem eine Haftung des Lieferanten, so hat der Besteller ihn schadlos zu halten. Das gilt nicht bei Vorsatz oder grober Fahrlässigkeit des Inhabers oder leitender Angestellter.
- Muster werden nur gegen Berechnung geliefert.
- Mündliche Nebenabreden bestehen nicht. Änderungen bedürfen der Schriftform.

## III. Umfang der Lieferung

- Für den Umfang der Lieferung ist die schriftliche Auftragsbestätigung des Lieferanten maßgebend, im Falle eines Angebots des Lieferanten mit zeitlicher Bindung und fristgemäßer Annahme das Angebot, sofern keine rechtzeitige Auftragsbestätigung vorliegt. Nebenabreden und Änderungen bedürfen der schriftlichen Bestätigung des Lieferanten.
- Werden Sonderwerkzeuge in Auftrag gegeben, so darf die Bestellmenge um ca. 10% mindestens jedoch um 2 Stück, über- oder unterschritten werden. Berechnet wird die Liefermenge.

## IV. Preis und Zahlung

- Die Preise gelten mangels besonderer Vereinbarung ab Werk einschließlich Verladung im Werk, jedoch ausschließlich Verpackung. Zu den Preisen kommt die Umsatzsteuer in der jeweiligen gesetzlichen Höhe hinzu.
- Mangels besonderer Vereinbarung ist die Zahlung ohne jeden Abzug frei Zahlstelle des Lieferanten innerhalb von 30 Tagen nach Rechnungsdatum (auch bei Teillieferungen) zu leisten.
- Das Recht, Zahlungen zurückzuhalten oder mit Gegenansprüchen aufzurechnen steht dem Besteller nur insoweit zu, als seine Gegenansprüche unbestritten und rechtskräftig festgestellt sind.
- Bei Überschreitung des Zahlungsziels werden unter Vorbehalt der Geltendmachung eines weiteren Schadens, Zinsen in Höhe von 3% über dem jeweiligen Basiszinssatz berechnet.
- Entstehen nach Vertragsabschluss Zweifel an der Zahlungsfähigkeit oder der Zahlungswilligkeit des Bestellers, so hat der Lieferer das Recht die Leistung zu verweigern, bis die Zahlung erfolgt ist oder Sicherheit für die Zahlung geleistet ist.
- Der Lieferer übernimmt keine Kosten für Verwertung oder den Rücktransport von Verpackungsmaterial.
- Unser Mindestrechnungswert beträgt z. Z. € 50,00 ohne MwSt. und Porto/Verpackung. Aufträge mit geringerem Wert ergänzen wir mit gleichen oder ähnlichen Werkzeugen.

## V. Lieferzeit

- Die Lieferzeit ergibt sich aus den Vereinbarungen der Vertragsparteien. Ihre Einhaltung durch den Lieferer setzt voraus, dass alle kaufmännischen und technischen Fragen zwischen den Vertragsparteien geklärt sind und der Besteller alle ihm obliegenden Verpflichtungen, wie z.B. Beibringung der erforderlichen behördlichen Bescheinigungen oder Genehmigungen oder die Leistung einer Anzahlung erfüllt hat. Ist dies nicht der Fall, so verlängert sich die Lieferzeit angemessen. Dies gilt nicht, soweit der Lieferer die Verzögerung zu vertreten hat.
- Die Lieferfrist beginnt mit der Absendung der Auftragsbestätigung..
- Die Lieferfrist ist eingehalten, wenn der Liefergegenstand bis zu ihrem Ablauf das Werk des Lieferanten verlassen hat oder die Versandbereitschaft gemeldet ist. Soweit eine Abnahme zu erfolgen hat, ist - außer bei berechtigter Abnahmeverweigerung - der Abnahmetermin maßgebend, hilfsweise die Meldung der Abnahmebereitschaft.
- Werden der Versand bzw. die Abnahme des Liefergegenstandes aus Gründen verzögert, die der Besteller zu vertreten hat, so werden ihm, beginnend einen Monat nach Meldung der Versand- bzw. der Abnahmebereitschaft, die durch die Verzögerung entstandenen Kosten berechnet.

- Ist die Nichteinhaltung der Lieferzeit auf höhere Gewalt, auf Arbeitskämpfe oder sonstige Ereignisse, die außerhalb des Einflussbereiches des Lieferanten liegen, zurückzuführen, so verlängert sich die Lieferzeit angemessen. Der Lieferer wird dem Besteller den Beginn und das Ende derartiger Umstände baldmöglichst mitteilen. Dies gilt auch, wenn die Umstände bei Unterlieferern eintreten. Die vorbezeichneten Umstände sind auch dann vom Lieferer nicht zu vertreten, wenn sie während eines bereits vorliegenden Verzuges entstehen. Beginn und Ende derartiger Hindernisse wird in wichtigen Fällen der Lieferer dem Besteller baldmöglichst mitteilen.
- Der Besteller kann ohne Fristsetzung vom Vertrag zurücktreten, wenn dem Lieferer die gesamte Leistung vor Gefahrübergang endgültig unmöglich wird. Der Besteller kann darüber hinaus vom Vertrag zurücktreten, wenn bei einer Bestellung die Ausführung eines Teils der Lieferung unmöglich wird und er ein berechtigtes Interesse an der Ablehnung der Teillieferung hat. Ist dies nicht der Fall, so hat der Besteller den auf die Teillieferung entfallenden Vertragspreis zu zahlen. Dasselbe gilt bei Unvermögen des Lieferanten. Im Übrigen gilt Abschnitt IX.2. Tritt die Unmöglichkeit oder das Unvermögen während des Annahmeverzuges ein oder ist der Besteller für diese Umstände allein oder weit überwiegend verantwortlich, bleibt er zur Gegenleistung verpflichtet.
- Wird der Versand auf Wunsch des Bestellers verzögert, so ist der Lieferer berechtigt, nach Setzung und fruchtlosem Verlauf einer angemessenen Frist anderweitig über den Liefergegenstand zu verfügen und den Besteller mit angemessen verlängerter Frist zu beliefern.
- Die Einhaltung der Lieferfrist setzt die Erfüllung der Vertragspflichten des Bestellers voraus.
- Mangels besonderer Vereinbarung sind auf Abruf bestätigte Artikel spätestens innerhalb 12 Monaten ab Bestelldatum vollständig abzunehmen.
- Setzt der Besteller dem Lieferer - unter Berücksichtigung der gesetzlichen Ausnahmefälle - nach Fälligkeit eine angemessene Frist zur Leistung und wird die Frist nicht eingehalten, ist der Besteller im Rahmen der gesetzlichen Vorschriften zum Rücktritt berechtigt. Weitere Ansprüche aus Lieferverzug bestimmen sich ausschließlich nach Abschnitt IX.2 dieser Bedingungen.

## VI. Gefahrübergang und Entgegennahme

- Die Gefahr geht auf den Besteller über, wenn der Liefergegenstand das Werk verlassen hat, und zwar auch dann, wenn Teillieferungen erfolgen oder der Lieferer noch andere Leistungen, z.B. die Versandkosten oder Anlieferung und Aufstellung übernommen hat. Soweit eine Abnahme zu erfolgen hat, ist diese für den Gefahrübergang maßgebend. Sie muss unverzüglich zum Abnahmetermin, hilfsweise nach der Meldung des Lieferanten über die Abnahmebereitschaft durchgeführt werden. Der Besteller darf die Abnahme bei Vorliegen eines nicht wesentlichen Mangels nicht verweigern. Auf Wunsch des Bestellers wird auf seine Kosten die Sendung durch den Lieferer gegen Diebstahl, Bruch-, Transport-, Feuer und Wasserschäden sowie sonstige versicherbare Risiken versichert.
- Verzögert sich oder unterbleibt der Versand bzw. die Abnahme infolge von Umständen, die dem Lieferer nicht zuzurechnen sind, geht die Gefahr vom Tage der Meldung der Versand bzw. Abnahmebereitschaft auf den Besteller über. Der Lieferer verpflichtet sich, auf Kosten des Bestellers, die Versicherungen abzuschließen, die dieser verlangt.
- Teillieferungen sind zulässig, soweit für den Besteller zumutbar.

## VII. Eigentumsvorbehalt

- Der Lieferer behält sich das Eigentum an dem Liefergegenstand vor, bis sämtliche Forderungen des Lieferanten gegen den Besteller aus der Geschäftsverbindung einschließlich der künftig entstehenden Forderungen auch aus gleichzeitig oder später abgeschlossenen Verträgen beglichen sind. Dies gilt auch dann, wenn einzelne oder sämtliche Forderungen des Lieferanten in eine laufende Rechnung aufgenommen wurden und der Saldo gezogen und anerkannt ist.
- Der Besteller ist berechtigt, den Liefergegenstand im ordentlichen Geschäftsgang weiterzuverkaufen. Er tritt jedoch dem Lieferer bereits jetzt alle Forderungen mit sämtlichen Nebenabreden ab, die ihm aus der Weiterveräußerung gegen den Abnehmer oder Dritte erwachsen. Zur Einziehung dieser Forderungen ist der Besteller auch nach der Abtretung ermächtigt, so lange er sich vertrags-treu verhält und keine Zahlungsunfähigkeit vorliegt. Die Befugnis des Lieferanten, die Forderungen selbst einzuziehen, bleibt hiervon unberührt; jedoch verpflichtet sich der Lieferer, die Forderungen nicht einzuziehen, solange der Besteller seinen Zahlungsverpflichtungen ordnungsgemäß nachkommt. Der Lieferer kann verlangen, dass der Besteller ihm die abgetretenen Forderungen und deren Schuldner bekannt gibt, alle zum Einzug erforderlichen Angaben macht, die dazugehörigen Unterlagen aushändigt und den Schuldnern die Abtretung mitteilt. Wird der Liefergegenstand zusammen mit anderen Waren, die dem Lieferer nicht gehören, weiterverkauft, so gilt die Forderung des Bestellers gegen den Abnehmer in Höhe des zwischen Lieferer und Besteller vereinbarten Lieferpreises als abgetreten.
- Der Lieferer verpflichtet sich, die ihm zustehenden Sicherungen insoweit freizugeben, als ihr Wert die zu sichernden Forderungen, soweit diese noch nicht beglichen sind, um mehr als 20% übersteigt.
- Der Lieferer ist berechtigt, den Liefergegenstand auf Kosten des Bestellers gegen Diebstahl, Bruch-, Feuer-, Wasser- und sonstiger Schäden zu versichern, sofern nicht der Besteller selbst die Versicherung nachweislich abgeschlossen hat.

5. Der Besteller darf den Liefergegenstand weder verpfänden noch zur Sicherung übereignen. Bei Pfändungen sowie Beschlagnahme oder sonstigen Verfügungen durch dritte Hand hat er den Lieferer unverzüglich davon zu benachrichtigen.
6. Wird im Zusammenhang mit der Bezahlung des Kaufpreises durch den Besteller eine wechselseitige Haftung des Lieferers begründet, so erlöschen der Eigentumsverbehalt, einschließlich seiner vereinbarten Sonderformen, und sonstige zur Zahlungssicherung vereinbarte Sicherheiten nicht vor Einlösung des Wechsels durch den Besteller als Bezogenen.
7. Bei vertragswidrigem Verhalten des Bestellers, insbesondere bei Zahlungsverzug, ist der Lieferer zur Rücknahme des Liefergegenstandes nach Mahnung berechtigt und der Besteller zur Herausgabe verpflichtet. Bei Pfändungen oder sonstigen Eingriffen Dritter hat der Besteller den Lieferer unverzüglich schriftlich zu benachrichtigen.
8. Der Antrag auf Eröffnung des Insolvenzverfahrens berechtigt den Lieferer vom Vertrag zurückzutreten und die sofortige Rückgabe des Liefergegenstandes zu verlangen.

### VIII. Gewährleistung

Für Mängel der Lieferung haftet der Lieferer unter Ausschluss weiterer Ansprüche unbeschadet Abschnitt IX wie folgt:

#### Sachmängel

1. Der Besteller ist zur sofortigen Eingangskontrolle verpflichtet. Erkennbare Mängel müssen innerhalb von 14 Tagen nach Erhalt der Ware dem Lieferer schriftlich gemeldet werden. Alle diejenigen Teile sind unentgeltlich nach billigem Ermessen des Lieferers nachzubessern oder mangelfrei zu ersetzen, die sich infolge eines vor dem Gefahrübergang liegenden Umstandes als unbrauchbar oder in ihrer Brauchbarkeit nicht unerheblich beeinträchtigt herausstellen. Die Feststellung solcher Mängel ist dem Lieferer unverzüglich schriftlich zu melden. Ersetzte Teile werden Eigentum des Lieferers. Für Mängel des vom Besteller angelieferten Materials haftet der Lieferer nur, wenn er bei Anwendung fachmännischer Sorgfalt die Mängel hätte erkennen müssen. Für wesentliche Fremderzeugnisse beschränkt sich die Haftung des Lieferers auf die Abtretung der Haftungsansprüche, die ihm gegen den Lieferer des Fremderzeugnisses entstehen. Bei Fertigung nach Zeichnung des Bestellers haftet der Lieferer nur für zeichnungsgemäße Ausführung.
2. Zur Vornahme aller dem Lieferer nach billigem Ermessen notwendig erscheinenden Nachbesserungen und Ersatzlieferungen hat der Besteller nach Verständigung mit dem Lieferer die erforderliche Zeit und Gelegenheit zu geben, sonst ist der Lieferer von der Mängelhaftung befreit. Nur in dringenden Fällen der Gefährdung der Betriebssicherheit und zur Abwehr unverhältnismäßig großer Schäden, wobei der Lieferer sofort zu verständigen ist, hat der Besteller das Recht, den Mangel selbst oder durch Dritte beseitigen zu lassen und vom Lieferer Ersatz der erforderlichen Aufwendungen zu verlangen.
3. Von den durch die Nachbesserung bzw. Ersatzlieferung entstehenden unmittelbaren Kosten trägt der Lieferer - insoweit als sich die Beanstandung als berechtigt herausstellt - die Kosten des Ersatzstückes einschließlich des Versandes. Im Übrigen trägt der Besteller die Kosten.
4. Der Besteller hat im Rahmen der gesetzlichen Vorschriften ein Recht zum Rücktritt vom Vertrag, wenn der Lieferer - unter Berücksichtigung der gesetzlichen Ausnahmefälle - eine ihm gesetzte angemessene Frist für die Nachbesserung oder Ersatzlieferung wegen eines Sachmangels fruchtlos verstreichen lässt. Liegt nur ein unerheblicher Mangel vor, steht dem Besteller lediglich ein Recht zur Minderung des Vertragspreises zu. Das Recht auf Minderung des Vertragspreises bleibt ansonsten ausgeschlossen. Weitere Ansprüche bestimmen sich nach Abschnitt IX. 2 dieser Bedingungen.
5. Keine Gewähr wird insbesondere in folgenden Fällen übernommen: Ungeeignete oder unsachgemäße Verwendung, fehlerhafte Montage bzw. Inbetriebsetzung durch den Besteller oder Dritte, natürliche Abnutzung, fehlerhafte oder nachlässige Behandlung, nicht ordnungsgemäße Wartung, ungeeignete Betriebsmittel, mangelhafte Bauarbeiten, ungeeigneter Baugrund, chemische, elektrochemische oder elektrische Einflüsse - sofern sie nicht vom Lieferer zu verantworten sind.
6. Bessert der Besteller oder ein Dritter unsachgemäß nach, besteht keine Haftung des Lieferers für die daraus entstehenden Folgen. Gleiches gilt für ohne vorherige Zustimmung des Lieferers vorgenommene Änderungen des Liefergegenstandes.

#### Rechtsmängel

7. Führt die Benutzung des Liefergegenstandes zur Verletzung von gewerblichen Schutzrechten oder Urheberrechten im Inland, wird der Lieferer auf seine Kosten dem Besteller grundsätzlich das Recht zum weiteren Gebrauch verschaffen oder den Liefergegenstand in für den Besteller zumutbarer Weise derart modifizieren, dass die Schutzrechtsverletzung nicht mehr besteht. Ist dies zu wirtschaftlich angemessenen Bedingungen oder in angemessener Frist nicht möglich, ist der Besteller zum Rücktritt vom Vertrag berechtigt. Unter den genannten Voraussetzungen steht auch dem Lieferer ein Recht zum Rücktritt vom Vertrag zu. Darüber hinaus wird der Lieferer den Besteller von unbestrittenen oder rechtskräftig festgestellten Ansprüchen der betreffenden Schutzrechtinhaber freistellen.

8. Die in Abschnitt VIII. 7 genannten Verpflichtungen des Lieferers sind vorbehaltlich Abschnitt IX.2 für den Fall der Schutz- oder Urheberrechtsverletzung abschließend. Sie bestehen nur, wenn
  - der Besteller den Lieferer unverzüglich von geltend gemachten Schutz- oder Urheberrechtsverletzungen unterrichtet,
  - der Besteller den Lieferer in angemessenem Umfang bei der Abwehr der geltend gemachten Ansprüche unterstützt bzw. dem Lieferer die Durchführung der Modifizierungsmaßnahmen gemäß Abschnitt VIII. 7 ermöglicht,
  - dem Lieferer alle Abwehrmaßnahmen einschließlich außergerichtlicher Regelungen vorbehalten bleiben,
  - der Rechtsmangel nicht auf einer Anweisung des Bestellers beruht und
  - die Rechtsverletzung nicht dadurch verursacht wurde, dass der Besteller den Liefergegenstand eigenmächtig geändert oder in einer nicht vertragsgemäßen Weise verwendet hat.

### IX. Haftung

1. Wenn der Liefergegenstand durch Verschulden des Lieferers infolge unterlassener oder fehlerhafter Ausführung von vor oder nach Vertragsschluss erfolgten Vorschlägen und Beratungen oder durch die Verletzung anderer vertraglicher Nebenverpflichtungen - insbesondere Anleitung für Bedienung und Wartung des Liefergegenstandes - vom Besteller nicht vertragsgemäß verwendet werden kann, so gelten unter Ausschluss weiterer Ansprüche des Bestellers die Regelungen der Abschnitte VIII und IX.2 entsprechend.
2. Für Schäden, die nicht am Liefergegenstand selbst entstanden sind, haftet der Lieferer - aus welchen Rechtsgründen auch immer - nur
  - bei Vorsatz,
  - bei grober Fahrlässigkeit des Inhabers / der Organe oder leitender Angestellter,
  - bei schuldhafter Verletzung von Leben, Körper, Gesundheit,
  - bei Mängeln, die er arglistig verschwiegen oder deren Abwesenheit er garantiert hat,
  - bei Mängeln des Liefergegenstandes, soweit nach Produkthaftungsgesetz für Personen oder Sachschäden an privat genutzten Gegenständen gehaftet wird. Bei schuldhafter Verletzung wesentlicher Vertragspflichten haftet der Lieferer auch bei grober Fahrlässigkeit nicht leitender Angestellter und bei leichter Fahrlässigkeit, in letzterem Fall begrenzt auf den vertragstypischen, vernünftigerweise vorhersehbaren Schaden. Weitere Ansprüche sind ausgeschlossen.

### X. Verjährung

Alle Ansprüche des Bestellers - aus welchen Rechtsgründen auch immer - verjähren in 12 Monaten. Für vorsätzliches oder arglistiges Verhalten sowie bei Ansprüchen nach dem Produkthaftungsgesetz gelten die gesetzlichen Fristen.

### XI. Recht des Lieferers auf Rücktritt

Für den Fall unvorhergesehener Ereignisse im Sinne des Abschnittes V., sofern sie die wirtschaftliche Bedeutung oder den Inhalt der Leistung erheblich verändern oder auf den Betrieb des Lieferers erheblich einwirken, und für den Fall nachträglich sich herausstellender Unmöglichkeit der Ausführung, wird der Vertrag angemessen angepasst. Soweit dies wirtschaftlich nicht vertretbar ist, steht dem Lieferer das Recht zu, ganz oder teilweise vom Vertrag zurückzutreten. Schadenersatzansprüche des Bestellers wegen eines solchen Rücktritts bestehen nicht. Will der Lieferer vom Rücktrittsrecht Gebrauch machen, so hat er dies nach Erkenntnis der Tragweite des Ereignisses unverzüglich dem Besteller mitzuteilen, und zwar auch dann, wenn zunächst mit dem Besteller eine Verlängerung der Lieferfrist vereinbart war.

### XII. Besondere Bedingungen für Bearbeitungsverträge (Fertigstellung, Aufarbeitung, Umarbeitung oder Wiederherstellung von Werkzeugen und sonstige Lohnbearbeitung)

Ergänzend zu oder abweichend von den Allgemeinen Geschäftsbedingungen gilt für derartige Bearbeitungsverträge:

1. Die Rechnungen sind sofort ohne Abzug zu bezahlen.
2. Für das Verhalten des an den Bearbeiter eingesandten Materials übernimmt dieser keine Haftung. Sein Anspruch auf Vergütung bleibt unberührt.
3. Wird das Material bei der Bearbeitung durch Verschulden des Bearbeiters unbrauchbar, entfallen der Vergütungsanspruch des Bearbeiters und ein etwaiger Schadenersatzanspruch des Bestellers. Dieser Haftungsausschluss gilt nicht bei Vorsatz, grober Fahrlässigkeit des Inhabers oder leitender Angestellter.
4. Die Anlieferung des Materials hat frei Haus des Bearbeiters und in entsprechender wiederverwertbarer Verpackung zu erfolgen. Die Rücklieferung erfolgt zu Lasten des Bestellers.

### XIII. Gerichtsstand

1. Für alle Rechtsbeziehungen zwischen dem Lieferer und dem Besteller gilt ausschließlich das für die Rechtsbeziehungen inländischer Parteien untereinander maßgebliche Recht der Bundesrepublik Deutschland.
2. Gerichtsstand ist das für den Sitz des Lieferers zuständige Gericht. Der Lieferer ist jedoch berechtigt, am Hauptsitz des Bestellers Klage zu erheben.

Wilh. Becker GmbH & Co KG  
HAHNREITER Gewindetechnik

Stand 10.3.2016

